

SHM International Corp
 1861 West Oak Parkway
 Marietta, GA 30067

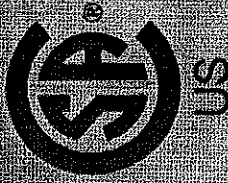

Model	SLB1VMV21 Z4 Z7 30LP
Gas Type	Propane/LP
Input MBH	39,000(B)HP
Input Mils	22,000(B)HP
Manifold Pressure	10" WC
Max. Inlet Pressure	14" WC
Min. Inlet Pressures	11" WC
Min. Fireplace Size 18"	18" H x 22" W x 15" D
Max. Fireplace Size 21"	18" H x 28" W x 15" D
Min. Fireplace Size 27"	18" H x 36" W x 15" D

See page 10 for specifications

This appliance is equipped with a SHM 820 NOVA valve.

WARNING: This appliance is for installation only in a solid-fuel burning masonry or 1/2" (127 factory built fireplace or in a rated ventless fireplace enclosure. It has been design certified for these installations. EXCEPT FOR: DO NOT install this appliance in a factory built fireplace that includes masonry surrounding the unit. This method of installation should not be used with ventless gas logs.

Minimum Clearance
 Clearance to combustibles: 600 mm (24")
 Clearance to combustibles: 102 mm (4")
 For other restrictions, refer to supplementary clearance information.

This appliance is only for use with propane gas.
 This appliance shall not be used on any other gas.

21FVC20169463

Serial No.

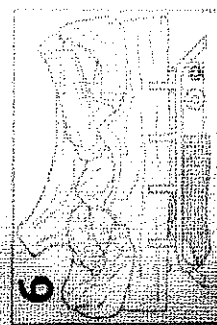

WARNING: Improper installation, adjustment, alteration, service or maintenance can cause property damage, personal injury or loss of life. Call a professional service technician for installation and service. Do not use a burner, heat exchanger, heat or the necessary and approved gas valve with this heater.

This appliance may be installed in an aftermarket, permanently located, manufactured (mobile) home, where not prohibited by local codes.
 This appliance is only for use with the type of gas indicated on the rating plate.
 This appliance is not convertible for use with other gases.

WARNING: Fan flames or sparks must be allowed while the appliance is operating.

If this appliance is installed in a fireplace that has glass doors, the doors must be kept closed while the appliance is in use.

Do not use this burner or gas control valve in a fireplace or ventless fireplace enclosure that is not specifically designed for this burner and gas control valve. See the manufacturer's instructions for the fireplace or ventless fireplace enclosure.

This appliance is not for use in a room with a volume less than 35 cubic feet per cubic foot of gas capacity of the appliance.

WARNING:

When used without adequate combustion and ventilation air, heater may give off excessive CARBON MONOXIDE, an odorless, poisonous gas.

DO NOT INSTALL HEATER UNTIL ALL NECESSARY PROVISIONS ARE MADE FOR COMBUSTION AND VENTILATION AIR. CONSULT THE WRITTEN INSTRUCTIONS PROVIDED WITH THE HEATER FOR INFORMATION CONCERNING COMBUSTION AND VENTILATION AIR. IN THE ABSENCE OF INSTRUCTIONS, REFER TO THE NATIONAL FUEL GAS CODE, ANSI Z223.7/NFPA 54, AIR FOR COMBUSTION AND VENTILATION, OR APPLICABLE LOCAL CODES.

This heater is equipped with a PILOT, LIGHT SAFETY SYSTEM designed to turn off the heater if not enough fresh air is available.

DO NOT TAMPER WITH PILOT LIGHT SAFETY SYSTEM!
 If heater shuts off, do not relight until you provide fresh air. If heater keeps shutting off, have it serviced. Keep burner and control compartment clean.

CARBON MONOXIDE POISONING MAY LEAD TO DEATH.
 Early signs of carbon monoxide poisoning resemble the flu, with headaches, dizziness, and/or nausea. If you have these signs, the burner may not be working properly. Get fresh air at once! Call for service.

Some people, pregnant women, persons with heart or lung disease, and those under the influence of alcohol, those at high altitudes, are more affected by carbon monoxide than others. Removal of this marking will void the compliance of the heater with ANSI Z21.11.2 - 2011 Underwriters Laboratories.

PLS SHM 21FVC 20169463 21FVC 20169463

VENT FREE GAS LOG SET

Owner's Operation and Installation Manual

(S,B)VFM18NG
(S,B)VFM18LP
(S,B)VFM24NG
(S,B)VFM24LP

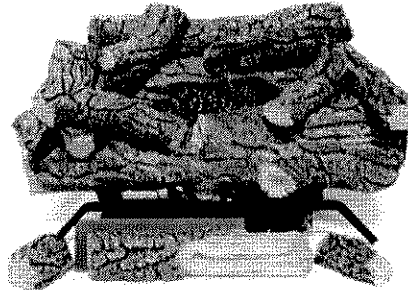

(S,B)IVFMV18NG
(S,B)IVFMV18LP
(S,B)IVFMV24NG
(S,B)IVFMV24LP

Also Design-Certified As Vented Decorative Appliances



ANSI Z21.11.2 - 2011
Unvented Heaters
ANSI Z21.60 - 2004
Vented Decorative

WARNING: If the information in this manual is not followed exactly, a fire or explosion may result causing property damage, personal injury, or loss of life.

- Do not store or use gasoline or other flammable vapors and liquids in the vicinity of this or any other appliance.
- **WHAT TO DO IF YOU SMELL GAS**
 - Do not try to light any appliance.
 - Do not touch any electrical switch; do not use any phone in your building.
 - Immediately call your gas supplier from a neighbor's phone. Follow the gas supplier's instructions.
 - If you cannot reach your gas supplier, call the fire department.
- Installation and service must be performed by a qualified installer, service agency, or the gas supplier.

This is an unvented gas-fired heater. It uses air (oxygen) from the room in which it is installed. Provisions for adequate combustion and ventilation air must be provided. Refer to page 4, Air for Combustion and Ventilation.

INSTALLER: Leave this manual with the appliance.
CONSUMER: Retain this manual for future reference.

This appliance has been tested and approved under ANSI Z21.11.2–2011 Unvented Gas-Fired Room Heaters.

WARNING: This appliance is for installation only in a solid fuel burning masonry or UL127 factory-built fireplace or listed ventless fire-box enclosure. It has been design certified for these installations. **EXCEPTION: DO NOT** install this appliance in a factory-built fireplace that includes instruction stating it has not been tested or should not be used with unvented gas logs.

This appliance may be installed in an aftermarket,* permanently located, manufactured (mobile) home, where not prohibited by local codes.

This appliance is only for use with the type of gas indicated on the rating plate. This appliance is not convertible for use with other gases.

* Aftermarket: Completion of sale, not for purpose of resale, from the manufacturer

TABLE OF CONTENTS

Safety Information	2
Local Codes	3
Unpacking	4
Product Features.....	4
Qualified Installation Agency	4
Air For Combustion and Ventilation	4
Installation.....	7
Operating Log Set.....	13
Inspecting Burners	18
Cleaning and Maintenance.....	18
Troubleshooting.....	19
Specifications	22
Parts List and Illustrated Parts Breakdown	24
Warranty Information	Back Cover

SAFETY INFORMATION

You must operate this heater with the fireplace screen in place. Make sure the fireplace screen is in place before funning this appliance.

Unless other provisions are made for combustion air, the screens shall have an opening or openings for introduction of combustion air into the fireplace

If this appliance is installed in a fireplace that has glass doors, the doors must be left open when the appliance is in use.

WARNING: Improper installation, adjustment, alteration, service, or maintenance can cause injury or property damage. Refer to this manual for correct installation and operational procedures. For assistance or additional information consult a qualified installer, service agency, or the gas supplier.

WARNING: This product contains and/or generates chemicals known to the state of California to cause cancer or birth defects or other reproductive harm.

▲ DANGER: Carbon monoxide poisoning may lead to death!

Carbon Monoxide Poisoning: Early signs of carbon monoxide poisoning resemble the flu, with headaches, dizziness, and/or nausea. If you have these signs, heater may not be working properly. **Get fresh air at once! Have heater serviced.** Some people—pregnant women, persons with heart or lung disease, anemia, those under the influence of alcohol, those at high altitudes—are more affected by carbon monoxide than others.

Propane/LP Gas: Propane/LP gas is odorless. An odor-making agent is added to the gas. The odor helps you detect a gas leak. However, the odor added to the gas can fade. Gas may be present even though no odor exists.

Make certain you read and understand all warnings. Keep this manual for reference. It is your guide to safe and proper operation of this appliance.

▲ WARNING: Any change to this heater or its controls can be dangerous.

▲ WARNING: Do not use a blower insert, heat exchanger insert, or other accessory not approved for use with this appliance.

▲ WARNING: Do not allow fans to blow directly into the appliance. Avoid any drafts that alter burner flame patterns. Ceiling fans can create drafts that alter burner flame patterns. Altered burner patterns can cause sooting.

Due to high temperatures, the appliance should be located out of traffic and away from furniture and draperies.

Do not place clothing or other flammable material on or near the appliance. Never place any objects on the heater.

Fireplace front and screen become very hot when running appliance. Keep children and adults away from hot surfaces to avoid burns or clothing ignition. Logs will remain hot for a time after shutdown. Allow surfaces to cool before touching.

Carefully supervise young children when they are in the room with fireplace.

SAFETY INFORMATION

CONTINUED

Keep the appliance area clear and free from combustible materials, gasoline, and other flammable vapors and liquids.

1. This appliance is only for use with the type of gas indicated on the rating plate. This appliance is not convertible for use with other gases.
2. Do not place propane/LP supply tank(s) inside any structure. Locate propane/LP supply tank(s) outdoors (propane/LP units only).
3. If you smell gas
 - shut off gas supply
 - do not try to light any appliance
 - do not touch any electrical switch; do not use any phone in your building
 - immediately call your gas supplier from a neighbor's phone. Follow the gas supplier's instructions
 - if you cannot reach your gas supplier, call the fire department
4. This appliance shall not be installed in a bedroom or bathroom.
5. Do not use this appliance as a wood-burning fireplace. Use only the logs provided with the appliance.
6. Do not add extra logs or ornaments such as pine cones, vermiculite or rock wool. Using these added items can cause sooting and poor combustion. Do not add lava rock around base. Rock and debris could fall into the control area of heater.
7. This appliance is designed to be smokeless. If logs ever appear to smoke, turn off appliance and call a qualified service person. Note: During initial operation, slight smoking could occur due to log curing and fireplace burning manufacturing residues.
8. To prevent the creation of soot, follow the instructions in *Cleaning and Maintenance* section.

Keep the appliance area clear and free from combustible materials, gasoline and other flammable vapors and liquids.

9. Before using furniture polish, wax, carpet cleaner, or similar products, turn heater off. If heated, the vapors from these products may create a white powder residue within burner box or on adjacent walls or furniture.
10. This appliance needs fresh air ventilation to run properly. This appliance has an Oxygen Depletion Sensing (ODS) safety shutoff system. The ODS shuts down the

fireplace if not enough fresh air is available. See *Air for Combustion and Ventilation*, pages 4 through 6. If appliance keeps shutting off, see *Troubleshooting*, pages 17 through 20.

11. Do not run appliance
 - where flammable liquids or vapors are used or stored
 - under dusty conditions
12. Do not use this appliance to cook food or burn paper or other objects.
13. Never place any objects in the heater or on logs.
14. Do not use appliance if any part has been exposed to or under water. Immediately call a qualified service technician to inspect the appliance and to replace any part of the control system and any gas control which has been under water.
15. Turn appliance off and let cool before servicing. Only a qualified service person should service and repair appliance.
16. Operating appliance above elevations of 4,500 feet could cause pilot outage.
17. To prevent performance problems, do not use propane/LP fuel tanks of less than 100 lbs. capacity.
18. Provide adequate clearances around air openings.

LOCAL CODES

Install and use appliance with care. Follow all local codes. In the absence of local codes, use the latest edition of The National Fuel Gas Code ANSI Z223.1/NFPA 54*.

*Available from:

American National Standards Institute, Inc.
1430 Broadway
New York, NY 10018

National Fire Protection Association, Inc.
Batterymarch Park
Quincy, MA 02269

State of Massachusetts: The installation must be made by a licensed plumber or gas fitter in the Commonwealth of Massachusetts.

Sellers of unvented propane or natural gas-fired supplemental room heaters shall provide to each purchaser a copy of 527 CMR 30 upon sale of the unit.

Vent-free gas products are prohibited for bedroom and bathroom installation in the Commonwealth of Massachusetts.

UNPACKING

1. Remove the carton and log wrap.
2. Remove all protective packaging applied to heater for shipment.
3. Make sure your logset includes one hardware packet.
4. Check heater for any shipping damage. If heater is damaged, call SHM International at (800) 229-5647 for replacement parts before returning to dealer.

PRODUCT FEATURES

SAFETY PILOT

This heater has a pilot with an Oxygen Depletion Sensing (ODS) safety shutoff system. The ODS/pilot is a required feature for vent-free room heaters. The ODS/pilot shuts off the heater if there is not enough fresh air.

PIEZO IGNITION SYSTEM

This heater has a piezo ignitor. This system requires no matches, batteries or other sources to light heater.

THERMOSTATIC HEAT CONTROL

Thermostat-controlled models have a thermostat sensing bulb and a control valve. The thermostat will automatically modulate the heat output to maintain a consistent room temperature. This results in greater heater comfort. This can also result in lower gas bills.

QUALIFIED INSTALLATION AGENCY

Installation and replacement of gas piping, gas utilization equipment or accessories and repair and servicing of equipment shall be performed only by a qualified agency. The term "qualified agency" means any individual, firm, corporation, or company that either in person or through a representative is engaged in and is responsible for:

- A. Installation, testing or replacements of gas piping or
- B. Connection, installation, testing, repair or servicing of equipment that is experienced in such work; that is familiar with all precautions required; and that has complied with all requirements of the authority having jurisdiction.

AIR FOR COMBUSTION AND VENTILATION

⚠ WARNING: This heater shall not be installed in a room or space unless the required volume of indoor combustion air is provided by the method described in the National Fuel Gas Code, ANSI Z223.1/ NFPA 54, the International Fuel Gas Code, or applicable local codes.

Read the following instructions to insure proper fresh air for this and other fuel-burning appliances in your home.

Today's homes are built more energy efficient than ever. New materials, increased insulation, and new construction methods help reduce heat loss in homes. Home owners weather strip and caulk around windows and doors to keep the cold air out and the warm air in. During heating months, home owners want their homes as airtight as possible.

While it is good to make your home energy efficient, your home needs to breathe. Fresh air must enter your home. All fuel-burning appliances need fresh air for proper combustion and ventilation.

Exhaust fans, fireplaces, clothes dryers, and fuel burning appliances draw air from the house to operate. You must provide adequate fresh air for these appliances. This will insure proper venting of vented fuel-burning appliances.

PROVIDING ADEQUATE VENTILATION

The following are excerpts from National Fuel Gas Code ANSI Z223.1/NFPA 54, Section 5.3, Air for Combustion and Ventilation.

All spaces in homes fall into one of the following ventilation classifications:

1. Unusually Tight Construction
2. Unconfined Space

The information on pages 4 through 6 will help you classify your space and provide adequate ventilation.

Unusually Tight Construction

The air that leaks around doors and windows may provide enough fresh air for combustion and ventilation. However, in buildings of unusually tight construction, you must provide additional fresh air.

Unusually tight construction is defined as construction where:

- walls and ceilings exposed to the outside atmosphere have a continuous water vapor retarder with a rating of one perm (6×10^{-11} kg per pa-sec- m^2) or less with openings gasketed or sealed and
- weather stripping has been added on openable windows and doors and
- caulking or sealants are applied to areas such as joints around window and door frames, between sole plates and floors, between wall-ceiling joints, between wall panels, at penetrations for plumbing, electrical, and gas lines, and at other openings.

If your home meets all of the three criteria above, you must provide additional fresh air. See *Ventilation Air From Outdoors*, page 5.

If your home does not meet all of the three criteria above, proceed to *Determining Fresh-Air Flow for Appliance Location*, page 6.

VENTILATION AIR

Ventilation Air From Inside Building

This fresh air would come from an adjoining unconfined space. When ventilating to an adjoining unconfined space, you must provide two permanent openings: one within 12" of the ceiling and one within 12" of the floor on the wall connecting the two spaces (see Figure 1). You can also remove door into adjoining room (see Figure 1). Follow the National Fuel Gas Code ANSI Z223.1/NFPA 54, Section 5.3, Air for Combustion and Ventilation for required size of ventilation grills or ducts.

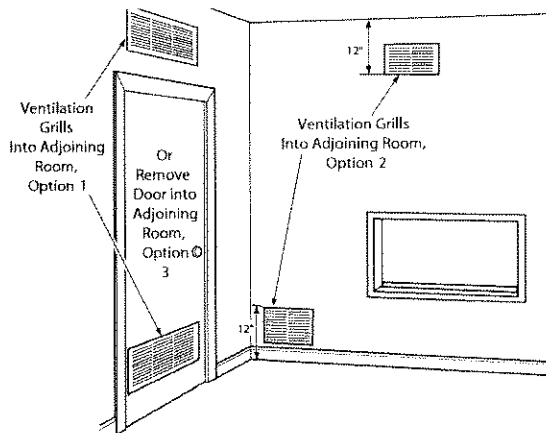

Figure 1 - Ventilation Air from Inside Building

Ventilation Air From Outdoors

Provide extra fresh air by using ventilation grills or ducts. You must provide two permanent openings: one within 12" of the ceiling and one within 12" of the floor. Connect these items directly to the outdoors or spaces open to the outdoors. These spaces include attics and crawl spaces. Follow the National Fuel Gas Code ANSI Z223.1/NFPA 54, Section 5.3, Air for Combustion and Ventilation for required size of ventilation grills or ducts.

IMPORTANT: Do not provide openings for inlet or outlet air into attic if attic has a thermostat-controlled power vent. Heated air entering the attic will activate the power vent.

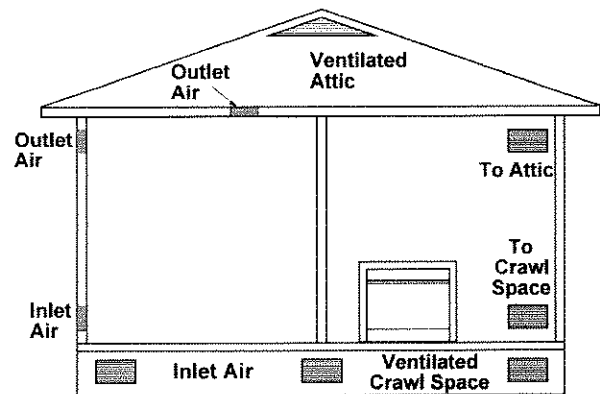

Figure 2 - Ventilation Air from Outdoors
DETERMINING FRESH-AIR FLOW FOR APPLIANCE LOCATION

Determining if You Have a Confined or Unconfined Space

Use this work sheet to determine if you have a confined or unconfined space.

Space: Includes the room in which you will install appliance plus any adjoining rooms with doorless passageways or ventilation grills between the rooms.

- Determine the volume of the space (length x width x height).

Length x Width x Height = cu. ft. (volume of space)

Example: Space size 22 ft. (length) x 18 ft. (width) x 8 ft. (ceiling height) = 3168 cu. ft. (volume of space)

If additional ventilation to adjoining room is supplied with grills or openings, add the volume of these rooms to the total volume of the space.

- Multiply the space volume by 20 to determine the maximum Btu/Hr the space can support.

_____ (volume of space) x 20 = (Maximum Btu/Hr the space can support)

Example: 3168 cu. ft. (volume of space) x 20 = 63,360 (maximum Btu/Hr the space can support)

AIR FOR COMBUSTION AND VENTILATION

CONTINUED

3. Add the Btu/Hr of all fuel burning appliances in the space.

Vent-free log set _____	Btu/Hr
Gas water heater* _____	Btu/Hr
Gas furnace _____	Btu/Hr
Vented gas heater _____	Btu/Hr
Gas fireplace logs _____	Btu/Hr
Other gas appliances* + _____	Btu/Hr
Total = _____	Btu/Hr

* Do not include direct-vent gas appliances. Direct-vent draws combustion air from the outdoors and vents to the outdoors.

Example:

Vent-free log set _____	39,000	Btu/Hr
Gas water heater* _____	40,000	Btu/Hr
Total = _____	79,000	Btu/Hr

4. Compare the maximum Btu/Hr the space can support with the actual amount of Btu/Hr used.

_____ Btu/Hr (max. the space can support)

_____ Btu/Hr (actual amt. of Btu/Hr used)

Example: 63,300 Btu/Hr (maximum the space can support)

73,000 Btu/Hr (actual amount of Btu/Hr used)

The space in the above example is a confined space because the actual Btu/Hr used is more than the maximum Btu/Hr the space can support. You must provide additional fresh air. Your options are as follows:

- A. Rework work sheet, adding the space of an adjoining room. If the extra space provides an unconfined space, remove door to adjoining room or add ventilation grills between rooms. See Ventilation Air from Inside Building, page 5.
- B. Vent room directly to the outdoors. See Ventilation Air from Outdoors, page 5.
- C. Install a lower Btu/Hr appliance, if lower Btu/Hr size makes room unconfined.

If the actual Btu/Hr used is less than the maximum Btu/Hr the space can support, the space is an unconfined space. You will need no additional fresh air ventilation.

⚠ WARNING: If the area in which the heater may be operated does not meet the required volume for indoor combustion air, combustion and ventilation air shall be provided by one of the methods described in the National Fuel Gas Code, ANSI Z223.1/ NFPA 54, the International Fuel Gas Code, or applicable local codes.

Note: When used as a vented heater, appliance must be installed only in a solid-fuel burning fireplace with a working flue and constructed of noncombustible material.

VENTED OPERATION

You may also use this heater as a vented product. There are three reasons for operating your heater in the vented mode.

1. The fireplace does not meet the clearance to combustibles requirements for vent-free operation.
2. State or local codes do not permit vent-free operation.
3. You prefer vented operation.

If reasons number 1 or 2 above apply to you, you must permanently open chimney flue damper. You must install the damper clamp. This will insure vented operation (see Figure 10). The damper clamp will keep damper open. See chart below for minimum permanent flue opening you must provide. Attach damper clamp so the minimum permanent flue opening will be maintained at all times.

Area of Various Standard Round Flues	
Diameter (ins.)	Area (sq. ins.)
5"	20 sq. inches
6"	29 sq. inches
7"	39 sq. inches
8"	51 sq. inches

Chimney Height (ft.)	Minimum Permanent Flue Opening (sq. ins.)
6' to 15'	39 sq. inches
15' to 30'	29 sq. inches

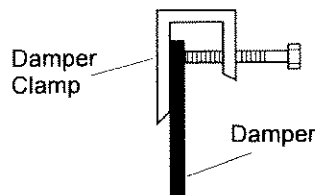

Follow instructions *Installing Damper Clamp* on page 8 for location of damper in the fireplace.

INSTALLATION

⚠ WARNING: Before installing in a solid-fuel-burning fireplace, the chimney flue and firebox must be cleaned of soot, creosote, ashes, and loose paint by a qualified chimney cleaner.

NOTICE: This appliance is intended for supplemental heating. Use this heater along with your primary heating system. Do not install this heater as your primary heat source. If you have a central heating system, you may run system's circulating blower while using heater. This will help circulate the heat throughout the house. In the event of a power outage, you can use this heater as your primary heat source.

⚠ WARNING: A qualified service person must install appliance. Follow all local codes.

⚠ WARNING: Never install the appliance

- in a recreational vehicle
- where curtains, furniture, clothing, or other flammable objects are less than 36 inches (91.5 cm) from the front, top, or sides of the appliance
- in a wood-burning stove
- in high traffic areas
- in windy or drafty areas

⚠ WARNING: Never install in a bedroom or bathroom. Any heating product with a Btu/Hr rating over 10,000 cannot be used in a bedroom. Any heating product with a Btu/Hr rating over 6,000 cannot be used in a bathroom.

⚠ CAUTION: This appliance creates warm air currents. These currents move heat to wall surfaces next to appliance. Installing appliance next to vinyl or cloth wall coverings or operating appliance where impurities (such as tobacco smoke, aromatic candles, cleaning fluids, oil or kerosene lamps, etc.) in the air exist, may discolor walls.

IMPORTANT: Vent-free heaters add moisture to the air. Although this is beneficial, installing appliance in rooms without enough ventilation air may cause mildew to form from too much moisture. See *Air for Combustion and Ventilation*, page 4.

CHECK GAS TYPE

Use the correct gas type (natural or propane/LP) for your appliance. If your gas supply is not correct or if you do not know your gas type, do not install appliance.

INSTALLATION ITEMS NEEDED

Before installing appliance, make sure you have the items listed below.

- external regulator for propane/LP unit only (supplied by installer)
- piping (check local codes)
- sealant (resistant to propane/LP gas)
- equipment shutoff valve *
- test gauge connection *
- ground joint union
- sediment trap (optional)
- tee joint
- pipe wrench
- approved flexible gas line (not provided), or provided gas connector (if allowed by local codes)

* A CSA/AGA design-certified equipment shutoff valve with 1/8" NPT tap is an acceptable alternative to test gauge connection. Purchase the optional CSA/AGA design-certified equipment shutoff valve from your dealer.

For propane/LP units, the installer must supply an external regulator. The external regulator will reduce incoming gas pressure. You must reduce incoming gas pressure to between 11 and 14 inches of water. If you do not reduce incoming gas pressure, heater regulator damage could occur.

LOG SET PLACEMENT

Place the log set in the center of your fireplace or firebox.

CLEARANCES (Vent-Free Operation Only)

⚠ WARNING: Maintain the minimum clearances. If you can, provide greater clearances from floor, ceiling, and adjoining wall.

Minimum Fireplace Clearance To Combustible Materials

Log Size	Side Wall	Ceiling
18", 21", 24"	15.5"	42"

Log Size	LOG SIZING REQUIREMENTS			
	Minimum Firebox Size			
	Height	Depth	Width Front	Width Rear*
18"	18"	12"	22"	18"
21", 24"	18"	15"	28"	22"

*Measured at 14" Depth

INSTALLATION

CONTINUED

INSTALLATION CLEARANCES

⚠ WARNING: Maintain the minimum clearances.

Mantel Clearances for Installation

If placing mantel above heater, you must meet the minimum clearance between the mantel shelf and the top of the firebox opening.

NOTICE: Surface temperatures of adjacent walls and mantels become hot during operation. Walls and mantels above the firebox may become hot to the touch. If installed properly, these temperatures meet the requirement of the national product standard. Follow all minimum clearances shown in this manual.

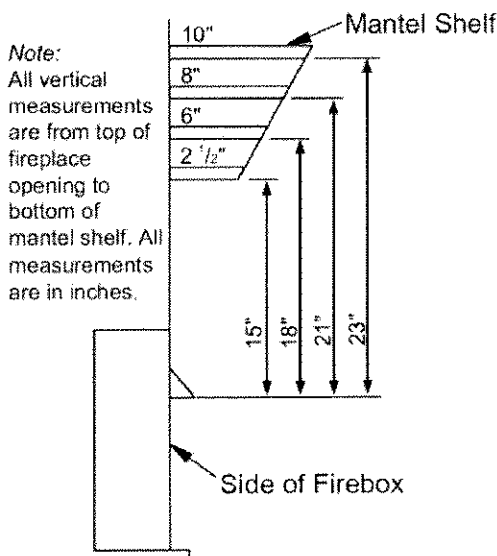
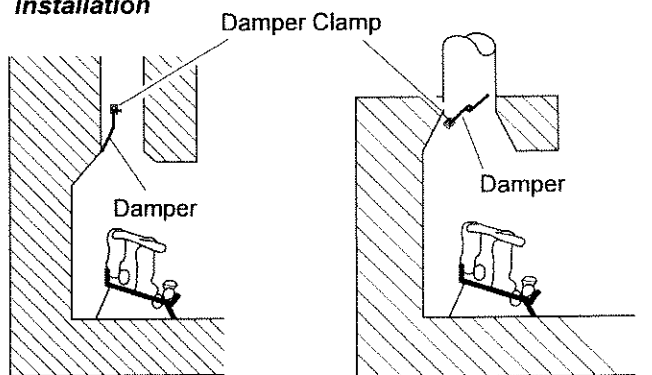

Figure 3 - Minimum Mantel Clearances for Installation



Masonry Fireplace

Manufactured Fireplace

INSTALLING DAMPER CLAMP ACCESSORY FOR VENTED OPERATION

CONNECTING TO GAS SUPPLY

⚠ WARNING: This appliance requires a 5/8" UNF (Unified National Fine Thread) and 1/2" NPT (National Pipe Thread) inlet connection and the gas connection tube provided.

⚠ WARNING: A qualified service person must connect log set to gas supply. Follow all local codes.

⚠ WARNING: Never connect natural gas log set to private (non-utility) gas wells. This gas is commonly known as wellhead gas.

IMPORTANT: For natural gas, check gas line pressure before connecting heater to gas line. Gas line pressure must be no greater than 10.5" of water. If gas line pressure is higher, heater regulator damage could occur.

⚠ CAUTION: Never connect propane/LP log set directly to the propane/LP supply. This appliance requires an external regulator (not supplied). Install the external regulator between the appliance and propane/LP supply.

For propane/LP gas, the installer must supply an external regulator. The external regulator will reduce incoming gas pressure. You must reduce incoming gas pressure to between 11" and 14" of water. If you do not reduce incoming gas pressure, heater regulator damage could occur. Install the external regulator with the vent pointing down as shown in Figure 4. Pointing the vent down protects it from freezing rain or sleet.

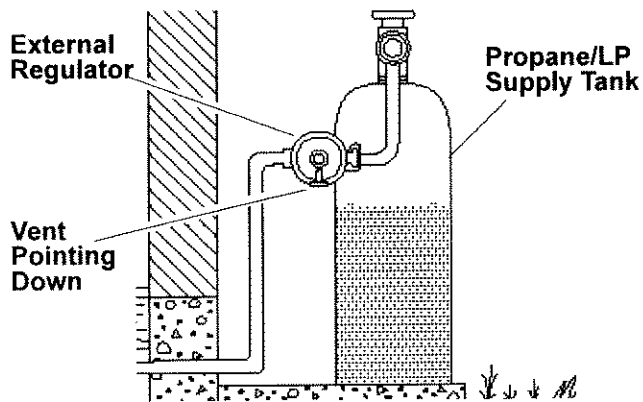

Figure 4 - External Regulator with Vent Pointing Down

▲ CAUTION: Use only new, black iron or steel pipe. Internally-tinned copper tubing may be used in certain areas. Check your local codes. Use pipe of 1/2" diameter or greater to allow proper gas volume to appliance. If pipe is too small, undue loss of pressure will occur.

▲ CAUTION: Use pipe joint sealant that is resistant to liquid petroleum (LP) gas.

Shutoff Valve

Installation must include an equipment shutoff valve, union, and plugged 1/8" NPT tap. Locate NPT tap within reach for test gauge hook up. NPT tap must be upstream from appliance.

IMPORTANT: Install equipment shutoff valve in an accessible location. The equipment shutoff valve is for turning on or shutting off the gas to the appliance.

Check your building codes for any special requirements for locating equipment shutoff valve to fireplaces.

Apply pipe joint sealant lightly to male NPT threads. This will prevent excess sealant from going into pipe. Excess sealant in pipe could result in clogged fireplace valves. Never use sealant on flare threads.

We recommend that you install a sediment trap in supply line as shown in Figure 5. Locate sediment trap where it is within reach for cleaning. Install in piping system between fuel supply and appliance. Locate sediment trap where trapped matter is not likely to freeze. A sediment trap traps moisture and contaminants. This keeps them from going into appliance gas controls. If sediment trap is not installed or is installed wrong, appliance may not run properly.

CHECKING GAS CONNECTIONS

▲ WARNING: Test all gas piping and connections, internal and external to unit, for leaks after installing or servicing. Correct all leaks at once.

▲ WARNING: Never use an open flame to check for a leak. Apply a mixture of liquid soap and water to all joints. Bubbles forming show a leak. Correct all leaks at once.

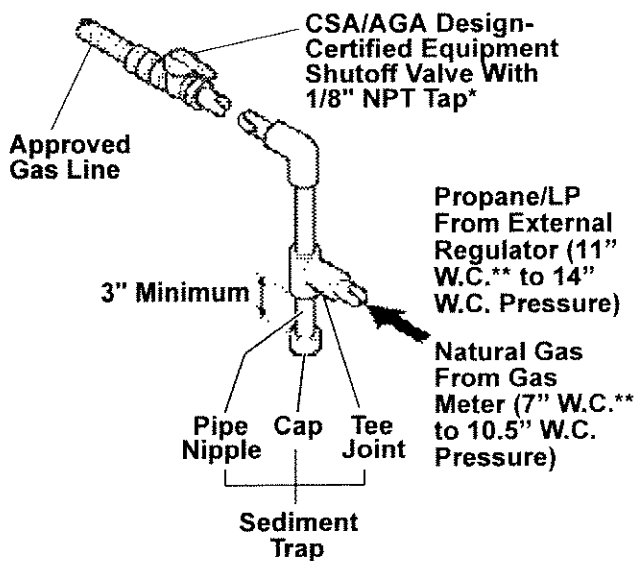

Figure 5 - Gas Connection

* Purchase the optional CSA/AGA design-certified equipment shutoff valve from your dealer.

** Minimum inlet pressure for purpose of input adjustment.

Pressure Testing Gas Supply Piping System

Test Pressures In Excess Of 1/2 PSI (3.5 kPa)

1. Disconnect appliance with its main gas valve (control valve) and equipment shutoff valve from gas supply piping system. Pressures in excess of 1/2 psi will damage appliance gas regulator.
2. Cap off open end of gas pipe where equipment shutoff valve was connected.
3. Pressurize supply piping system by either opening propane/LP supply tank valve for propane/LP gas or opening main gas valve located on or near gas meter of natural gas or using compressed air.
4. Check all joints of gas supply piping system. Apply noncorrosive leak detection fluid to all joints. Bubbles forming show a leak.
5. Correct all leaks at once.
6. Reconnect appliance and equipment shutoff valve to gas supply. Check reconnected fittings for leaks.

INSTALLATION

CONTINUED

Test Pressures Equal To or Less Than 1/2 PSIG (3.5 kPa)

1. Close equipment shutoff valve (see Figure 6).
2. Pressurize supply piping system by either opening propane/LP supply tank valve for propane/LP gas or opening main gas valve located on or near gas meter of natural gas or using compressed air.
3. Check all joints from gas meter to equipment shutoff valve for natural gas or propane/LP supply to equipment shutoff valve for propane/LP. Apply noncorrosive leak detection fluid to all joints. Bubbles forming show a leak.
4. Correct all leaks at once.

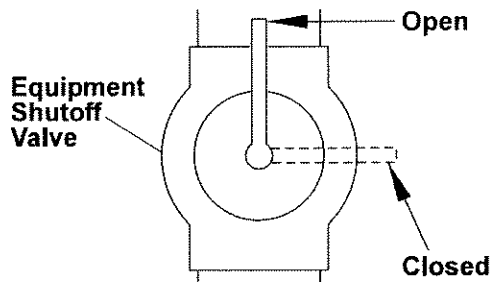

Figure 6 - Equipment Shutoff Valve

PRESSURE TESTING APPLIANCE GAS CONNECTIONS

1. Open equipment shutoff valve (see Figure 14).
2. For natural gas, open main gas valve located on or near gas meter. For propane/LP gas, open propane/LP supply tank valve.
3. Make sure control knob of fireplace is in the OFF position.
4. Check all joints from equipment shutoff valve to gas control valve. Apply noncorrosive leak detection fluid to all joints. Bubbles forming show a leak.
5. Correct all leaks at once.
6. Light fireplace (see *Operating Log Set*, page 13). Check all other internal joints for leaks.
7. Turn off fireplace (see *To Turn Off Gas To Log Set*, page 14).

OPTIONAL REMOTE CONTROL SET INSTALLATION AND SET-UP

Remote control purchased separately.

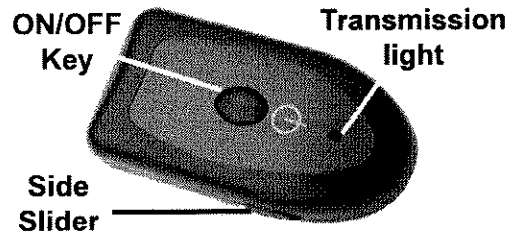
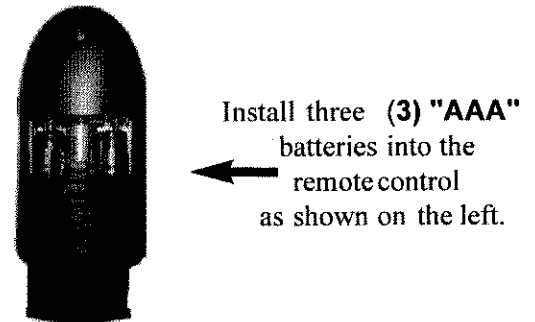
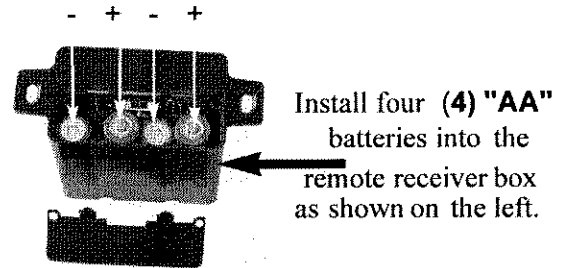

COMMUNICATION BETWEEN THE REMOTE CONTROL TRANSMITTER AND THE RECEIVER

To program the transmitter to the receiver move the three position slider of the receiver in the **REMOTE** position and depress the **ON/OFF** key of the transmitter. The System has an automatic learning mode that allows the receiver to mate with a new transmitter in the event the transmitter must be replaced. As soon as the receiver module receives the first correct command from any remote control it captures the new address and then "beeps" 3 times to confirm the synchronization and command execution.

Log Placement Savannah Oak 18

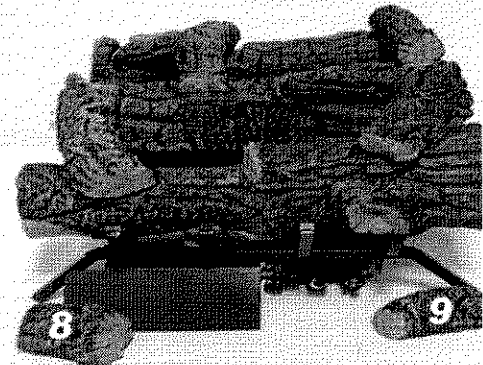
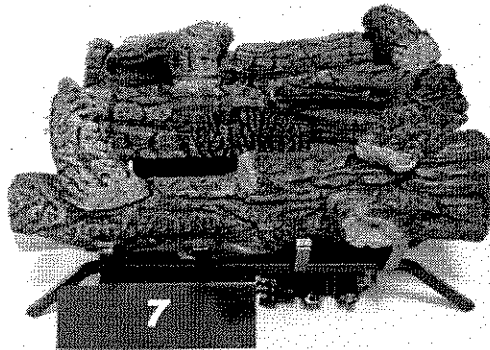
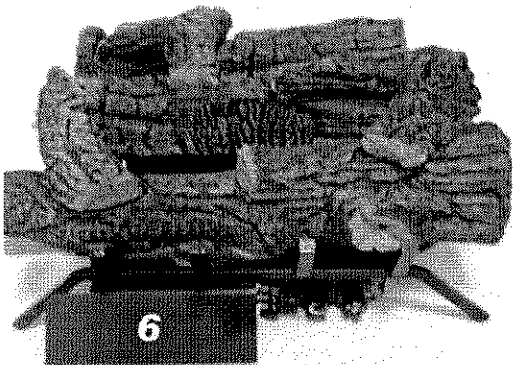
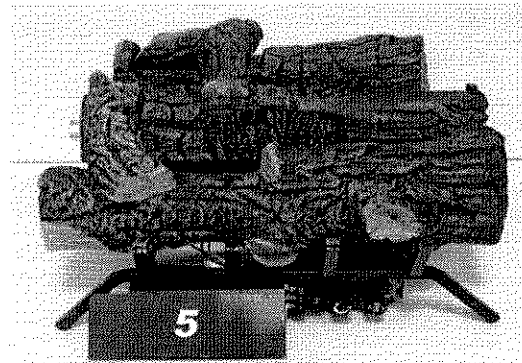
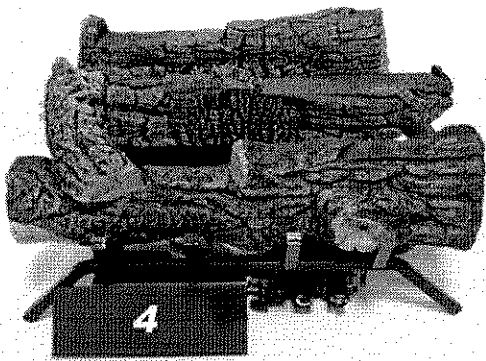
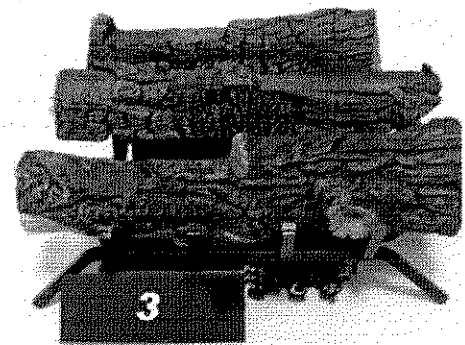
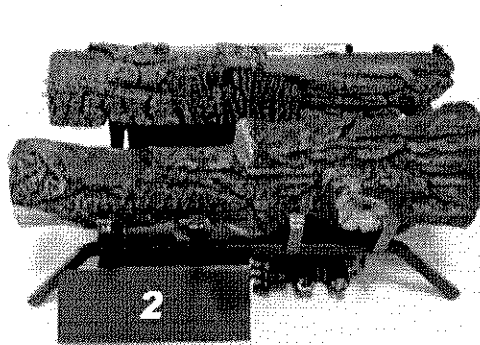
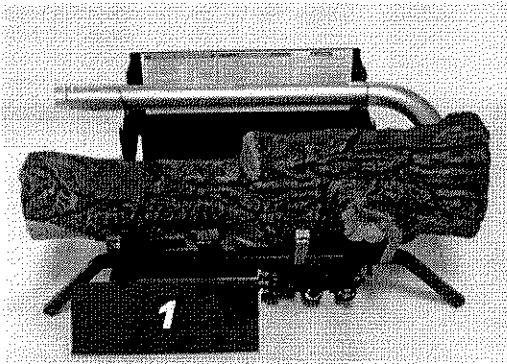
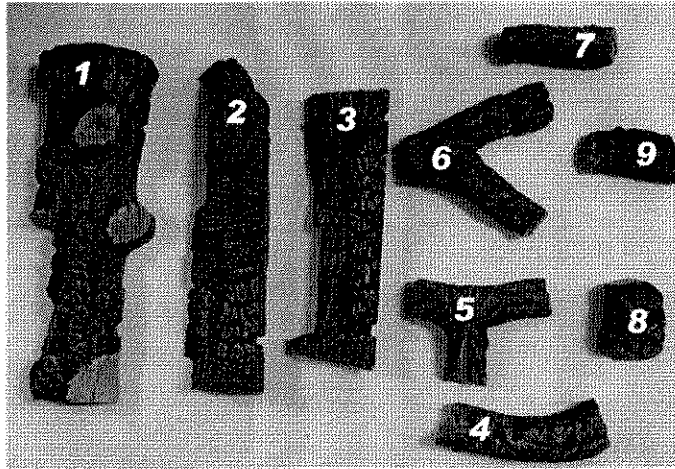

Log Placement Savannah Oak 24/30

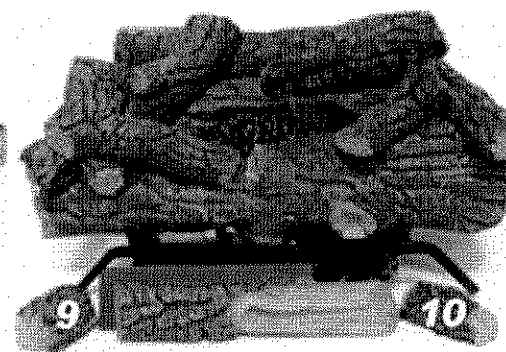
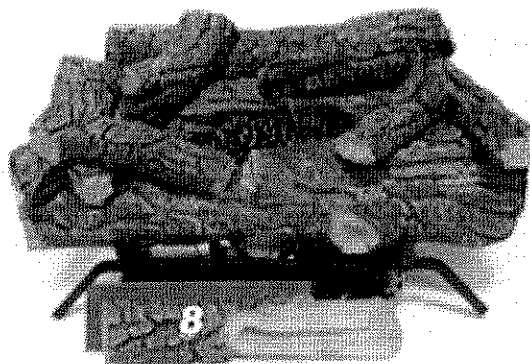
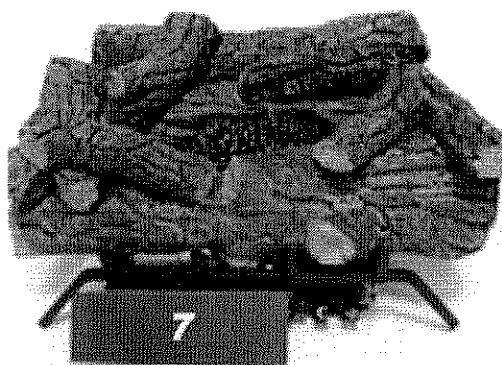
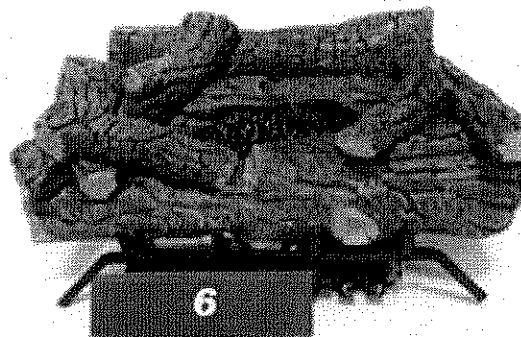
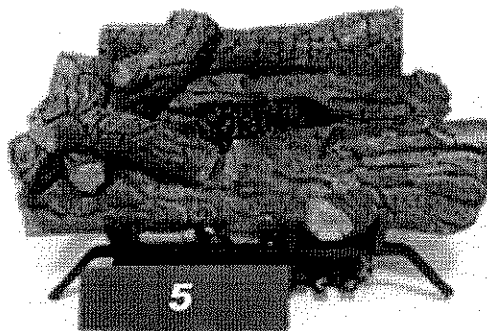
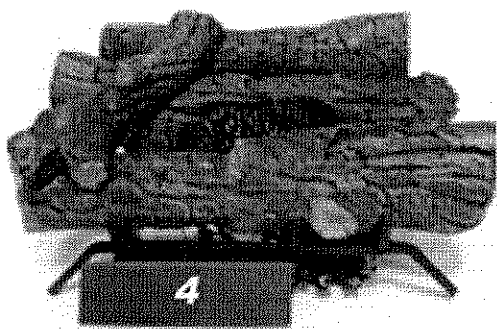
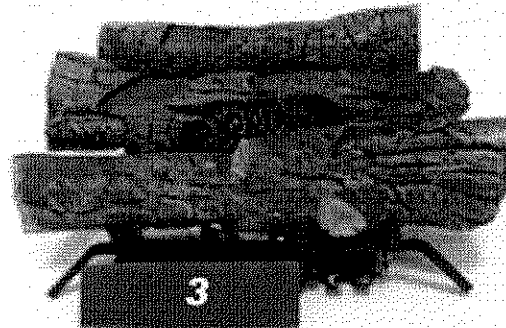
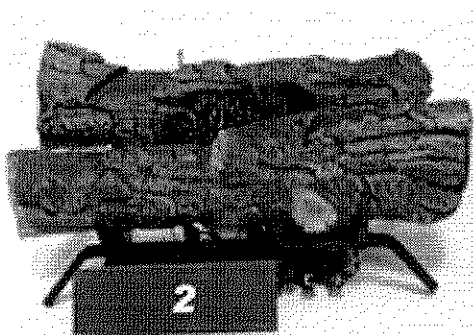
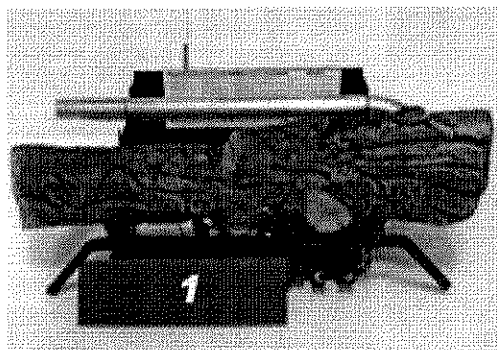
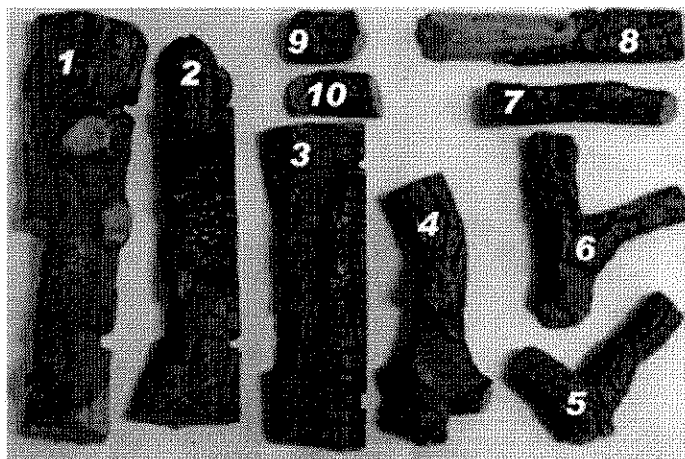

Log Placement, CVO(18,24,30) MV(18,24)VFM And OVM22

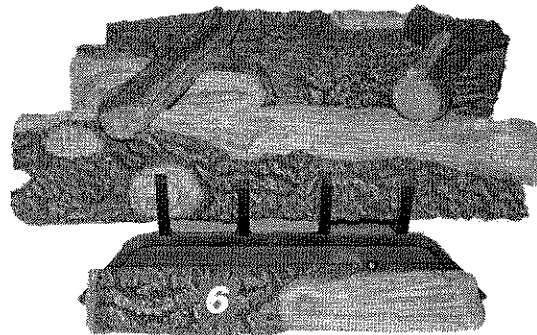
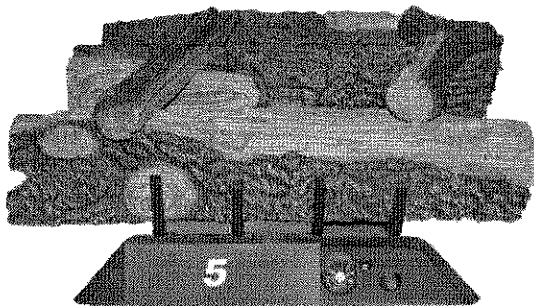
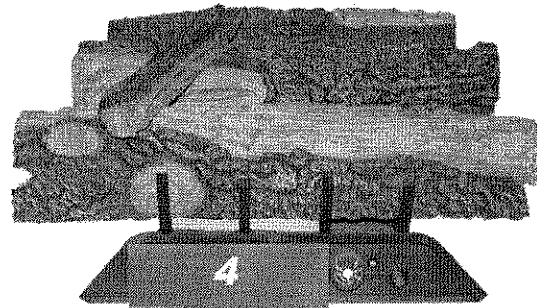
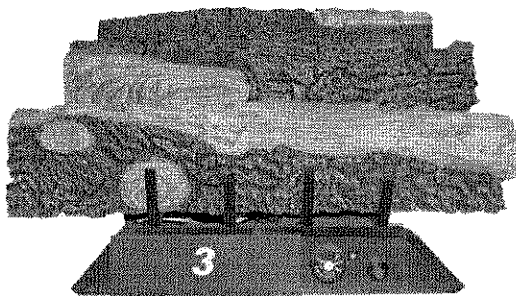
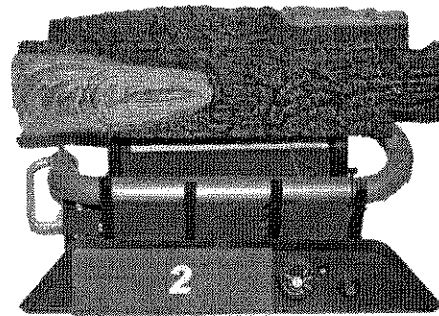
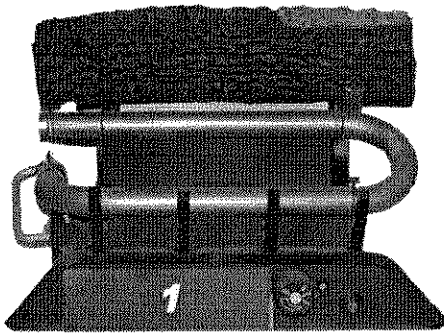
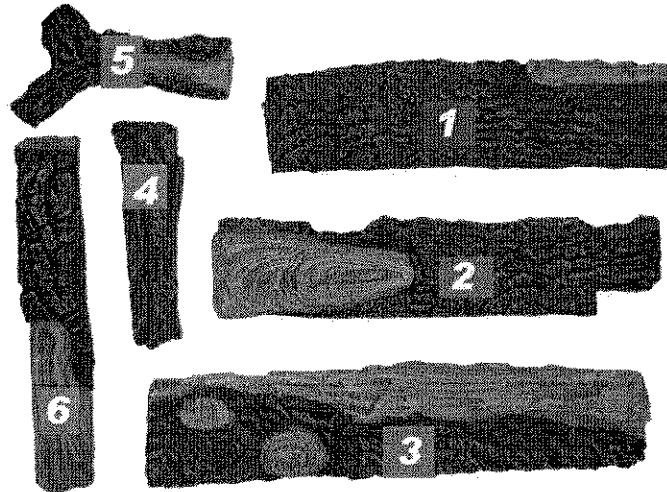

OPERATING HEATER

MANUALLY-CONTROLLED MODELS

FOR YOUR SAFETY
READ BEFORE LIGHTING

⚠ WARNING: If you do not follow these instructions exactly, a fire or explosion may result causing property damage, personal injury or loss of life.

A. This appliance has a pilot which must be lighted by hand. When lighting the pilot, follow these instructions exactly.

B. **BEFORE LIGHTING** smell all around the appliance area for gas. Be sure to smell next to the floor because some gas is heavier than air and will settle on the floor.

WHAT TO DO IF YOU SMELL GAS

- Do not try to light any appliance.
 - Do not touch any electric switch; do not use any phone in your building.
 - Immediately call your gas supplier from a neighbor's phone. Follow the gas supplier's instructions.
 - If you cannot reach your gas supplier, call the fire department.
2. Use only your hand to push in or turn the gas control knob. Never use tools. If the knob will not push in or turn by hand, don't try to repair it, call a qualified service technician or gas supplier. Force or attempted repair may result in a fire or explosion.
3. Do not use this appliance if any part has been under water. Immediately call a qualified service technician to inspect the appliance and to replace any part of the control system and any gas control which has been under water.

LIGHTING INSTRUCTIONS

⚠ WARNING:

- If fireplace has glass doors, never operate this heater with glass doors closed. If you operate heater with doors closed, heat buildup inside fireplace may cause glass to burst. Make sure there are no obstructions across openings of fireplace.
- You must operate this heater with a fireplace screen in place. Make sure fireplace screen is closed before running heater.

NOTICE: During initial operation of new heater, burning logs will give off a smell. Orange flame will also be present. Open damper or window to vent smell. This will only last a few hours.

Note: Home owners generally prefer to operate their heater with the chimney damper closed. This will put all the heat into the room. However, there may be times you will desire the full flames of the HI heat setting but will find the heat output excessive. You can open the chimney damper (if you have one) fully or partially to release some of the heat.

⚠ WARNING: Damper handle will be hot if heater has been running.

1. **STOP!** Read the safety information column 1.
2. Make sure equipment shutoff valve is fully open.
3. Turn control knob clockwise  to the OFF position.
4. Wait five (5) minutes to clear out any gas. Then smell for gas, including near the floor. If you smell gas, **STOP!** Follow "B" in the safety information, column 1. If you don't smell gas, go to the next step.

OPERATING HEATER

Continued

5. Slightly depress and turn control knob counterclockwise  to the PILOT position. Keep control knob pressed in for five (5) seconds (see Figure 15).

Note: You may be running this heater for the first time after hooking up to gas supply. If so, the control knob may need to be pressed in for 30 seconds or more. This will allow air to bleed from the gas system.

6. With control knob pressed in, press and release ignitor button. This will light pilot. The pilot is attached to the burner. If needed, keep pressing ignitor button until pilot lights.

Note: If pilot does not light, contact a qualified service person or gas supplier for repairs. Until repairs are made, light pilot with match. To light pilot with match, see *Manual Lighting Procedure*, column 2.

7. Keep control knob pressed in for 30 seconds after lighting pilot. After 30 seconds, release control knob.

• If control knob does not pop out when released, contact a qualified service person or gas supplier for repairs.

Note: If pilot goes out, repeat steps 3 through 7.

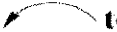
8. Slightly depress and turn control knob counterclockwise  to the HI position. The burner should light. Set control knob to any heat level between HI and LO.

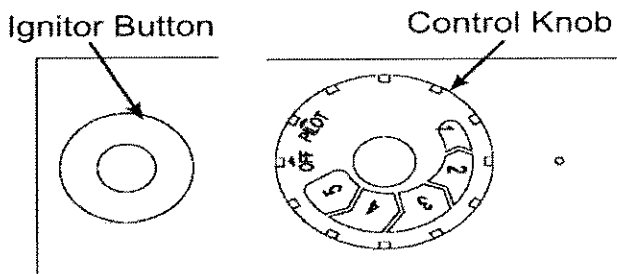
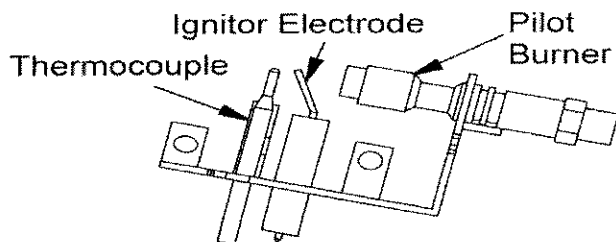

Figure 15



(Note: Appearance of pilot assembly may vary by model.)

Figure 16 - Pilot

CAUTION: Do not try to adjust heating levels by using the equipment shutoff valve.



VARIABLE CONTROL OPERATION

The variable control valve can be set to any heat setting and flame height desired, by simply turning the control knob until that setting is attained. Even the lowest setting provides realistic, dancing yellow flames. Selecting higher settings produces greater heat output. This results in increased heating comfort.

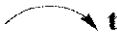

CAUTION: Do not try to adjust heating levels by using the equipment shutoff valve.

TO TURN GAS OFF TO APPLIANCE

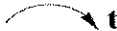
Shutting Off Heater

1. Press in and turn control knob clockwise  to the HI position.
2. Turn the control knob clockwise  to the PILOT position.
3. Press in control knob and turn clockwise  to the OFF position.

Shutting Off Burners Only (pilot stays lit)

1. Turn the control knob clockwise  to the HI position.
2. Press in and turn control knob clockwise  to the pilot position.

MANUAL LIGHTING PROCEDURE

1. Follow steps 1 through 5 under *Lighting Instructions*, page 13.
2. Press control knob and light pilot with match.
3. Keep control knob pressed in for 30 seconds after lighting pilot. After 30 seconds, release control knob. Now follow step 8 under *Lighting Instructions*.

OPERATING HEATER

Continued

REMOTE-READY MODELS

**FOR YOUR SAFETY
READ BEFORE LIGHTING**

⚠ WARNING: If you do not follow these instructions exactly, a fire or explosion may result causing property damage, personal injury or loss of life.

- A. This appliance has a pilot which must be lighted by hand. When lighting the pilot, follow these instructions exactly.
- B. **BEFORE LIGHTING** smell all around the appliance area for gas. Be sure to smell next to the floor because some gas is heavier than air and will settle on the floor.
- WHAT TO DO IF YOU SMELL GAS**
- Do not try to light any appliance.
 - Do not touch any electric switch; do not use any phone in your building.
 - Immediately call your gas supplier from a neighbor's phone. Follow the gas supplier's instructions.
 - If you cannot reach your gas supplier, call the fire department.
- C. Use only your hand to push in or turn the gas control knob. Never use tools. If the knob will not push in or turn by hand, don't try to repair it, call a qualified service technician or gas supplier. Force or attempted repair may result in a fire or explosion.
- D. Do not use this appliance if any part has been under water. Immediately call a qualified service technician to inspect the appliance and to replace any part of the control system and any gas control which has been under water.

LIGHTING INSTRUCTIONS

⚠ WARNING:

- If fireplace has glass doors, never operate this heater with glass doors closed. If you operate heater with doors closed, heat buildup inside fireplace may cause glass to burst. Make sure there are no obstructions across openings of fireplace.
- You must operate this heater with a fireplace screen in place. Make sure fireplace screen is closed before running heater.

NOTICE: During initial operation of new heater, burning logs will give off a smell.

Orange flame will also be present. Open damper or window to vent smell. This will only last a few hours.

Note: Home owners generally prefer to operate their heater with the chimney damper closed. This will put all the heat into the room. However, there may be times you will desire the full flames of the HI heat setting but will find the heat output excessive. You can open the chimney damper (if you have one) fully or partially to release some of the heat.



⚠ WARNING: Damper handle will be hot if heater has been running.

1. **STOP!** Read the safety information column 1.
2. Make sure equipment shutoff valve is fully open.
3. Set selector switch in the OFF position.

⚠ WARNING: Burners will come on automatically within one minute when the selector switch is in the ON position after the pilot is lit.

OPERATING HEATER 2

Continued

4. Press in and turn control knob clockwise  to the OFF position (see Figure 17).
5. Wait five (5) minutes to clear out any gas. Then smell for gas, including near the floor. If you smell gas, STOP! Follow "B" in the safety information, column 1, page 13. If you don't smell gas, go to the next step.
6. Press in and turn control knob counter-clockwise  to the PILOT position. Press in control knob for five (5) seconds (see Figure 17).

Note: You may be running this heater for the first time after hooking up to gas supply. If so, the control knob may need to be pressed in for 30 seconds or more. This will allow air to bleed from the gas system.

7. With control knob pressed in, press and release ignitor button. This will light pilot. The pilot is attached to the front burner. If needed, keep pressing ignitor button until pilot lights.

Note: If pilot does not stay lit, contact a qualified service person or gas supplier for repairs.

8. Keep control knob pressed in for 30 seconds after lighting pilot. After 30 seconds, release control knob.

• If control knob does not pop out when released, contact a qualified service person or gas supplier for repairs.

Note: If pilot goes out, repeat steps 4 through 8.

9. Slightly push in and turn control knob counter-clockwise  to the ON position.
10. Wait one minute and switch selector switch to the ON position to light burners.
11. Set flame adjustment knob to any level between HI and LO.

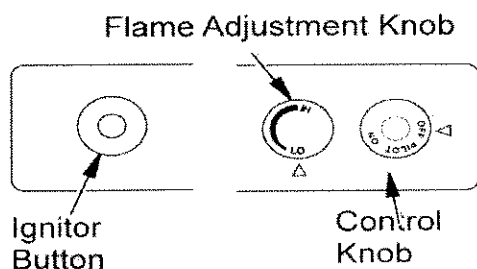

Figure 17 - Control Knob and Ignitor Button Location

CAUTION: Do not try to adjust heating levels by using the equipment shutoff valve.

WARNING: Make sure the selector switch is in the OFF position when you are away from home for long periods of time. Heater will come on automatically with selector switch in the ON position.

Note: The pilot flame on natural gas units will have a slight curve, but flame should be blue and have no yellow or orange color.

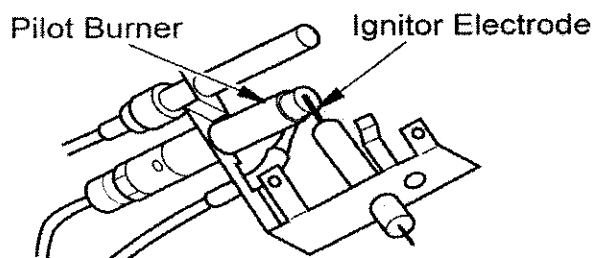

Figure 18 - Pilot (Propane/LP)

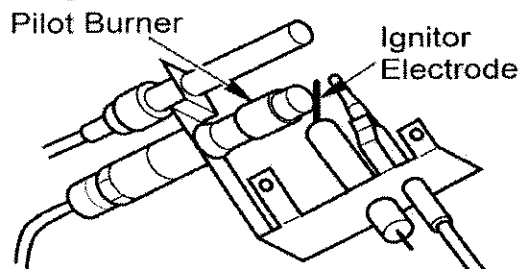



Figure 19 - Pilot (Natural)

TO TURN GAS OFF TO APPLIANCE

Shutting Off Heater

1. Turn control knob clockwise  to the OFF position.
- 2a. Set selector switch in the OFF position.
- 2b. If Using Optional Hand-Held Remote: Set selector switch in the OFF position to prevent draining battery.

Shutting Off Burners Only (pilot stays lit)
You may shut off the burners and keep the pilot lit by doing one of the following:

1. Turn control knob clockwise  to the PILOT position.
2. Use remote control manual OFF button.
3. Set selector switch in the OFF position.

OPTIONAL HAND-HELD REMOTE OPERATION

Note: All remote control accessories must be purchased separately.

Follow instructions included with the remote control.

NOTICE: You must light the pilot before using the hand-held remote control unit. See *Lighting Instructions* on page 15.

After lighting, let pilot flame burn for about one minute. Turn control knob to ON position. Adjust flame adjustment knob anywhere between HI and LO. Slide the selector switch to the REMOTE position (see Figure 20).

Note: The burner may light if hand-held remote was on when selector switch was last turned off. You can now turn the burner on and off with the hand-held remote control unit.

IMPORTANT: Do not leave the selector switch in the REMOTE or ON position when the pilot is not lit. This will drain the battery.

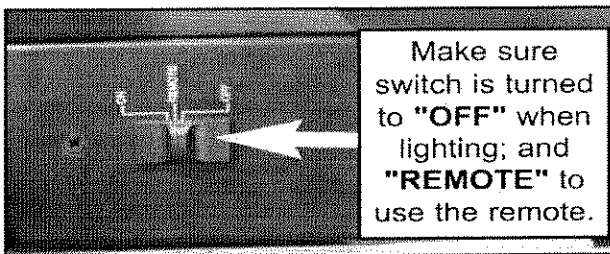
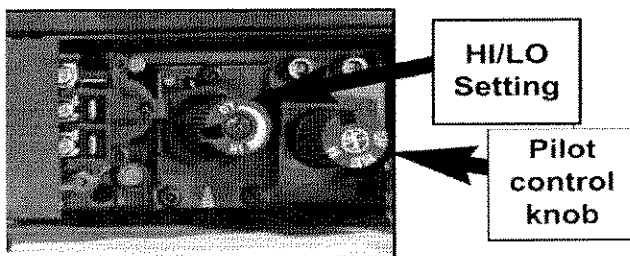

Figure 20 - Setting the Selector Switch, Control Knob and Flame Adjustment

BACKUP FUNCTION

If the batteries of the Receiver are low, the appliance can be switched on manually by moving the 3 position slider switch on the Receiver to the ON position.

Continued

Hand-Held Remote Operation

Hold the control button on the hand-held remote until burner turns on. Hold the control button again until burner turns off.

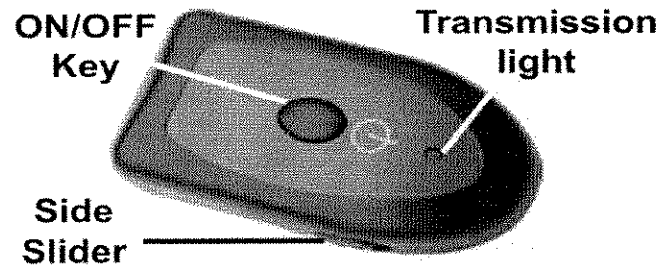

Figure 21 - On/Off Hand-Held Remote Control Unit

Manual Mode

1. Press the **Side Slider** to turn on the hand-held remote control.
2. Press the **POWER** button to turn on the fireplace.
3. Press the **POWER** button to turn off the fireplace.

WIRING DIAGRAM

Note: For proper operation of optional accessories, the wires from the thermopile to the control must be connected exactly as shown.

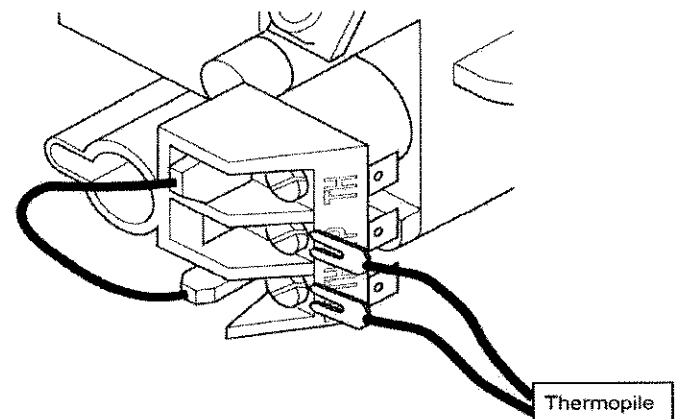

IMPORTANT !

Check and make sure the logs are clear of the burner flame. Flames touching the logs can produce sooting!

INSPECTING BURNERS

Check pilot flame pattern and burner flame patterns often.

PILOT FLAME PATTERN

Figure 22 shows a correct pilot flame pattern. Figure 23 shows an incorrect pilot flame pattern. The incorrect pilot flame is not touching the flame sensor. This will cause the flame sensor to cool. When the flame sensor cools, the fireplace will shut down.

If pilot flame pattern is incorrect, as shown in Figure 23

- turn fireplace off (see *Turning OFF The Appliance*, page 14)
- see *Cleaning and Maintenance*

Note: The pilot flame on natural gas units will have a slight curve, but flame should be blue and have no yellow or orange color.

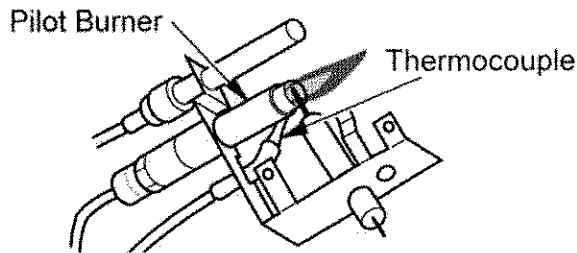

Figure 22 - Correct Pilot Flame Pattern
(Your pilot may vary from pilots shown)

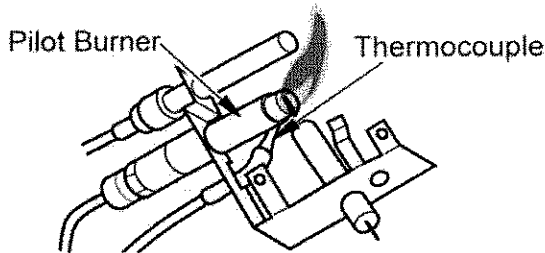

Figure 23- Incorrect Pilot Flame Pattern
(Your pilot may vary from pilots shown)

MAIN BURNER

Periodically inspect all burner flame holes with the fireplace running. Some burner flame holes may become blocked by debris or rust, with no flame present. If so, turn off fireplace and let cool. Remove blockage. Blocked burner flame holes may create soot.

BURNER FLAME PATTERN

Figure 24 shows correct burner flame pattern. Figure 25 shows incorrect burner flame pattern. The correct burner flame pattern shows yellow tipping at top of blue flame. If burner flame pattern is incorrect, as shown in Figure

- turn fireplace off (see *Turning OFF The Appliance*, page 16)
- see *Troubleshooting*, page 1

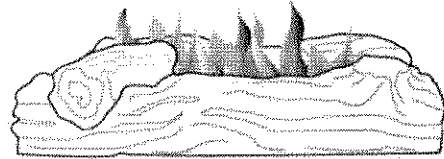

Figure 24 - Correct Burner Flame Pattern
Showing Blue Flame with Yellow/White Tips

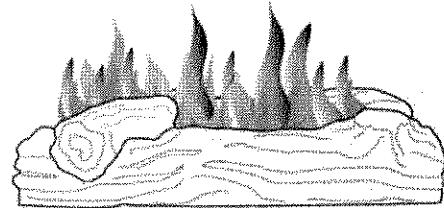

Figure 25 - Incorrect Burner Flame Pattern
Showing Solid Yellow/Orange Flame

CLEANING AND MAINTENANCE

WARNING: Turn off fireplace and let cool before cleaning.

CAUTION: Keep burner and control compartment clean. See installation and operating instructions accompanying heater. Inspect these areas of fireplace before each use. Have fireplace inspected yearly by a qualified service person. Fireplace may need more frequent cleaning due to excessive lint from carpeting, bedding material, pet hair, etc.

WARNING: Failure to keep the primary air opening of the burner clean may result in sooting and property damage.

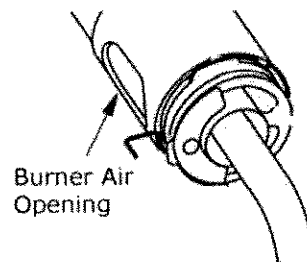

Figure 26 - Injector Holder On Outlet Burner Tube

BURNER INJECTOR HOLDER AND PILOT AIR INLET HOLE

The primary air inlet holes allow the proper amount of air to mix with the gas. This provides a clean burning flame. Keep these holes clear of dust, dirt, lint, and pet hair. Clean these air inlet holes prior to each heating season. Blocked air holes will create soot. We recommend that you clean the unit every three months during operation and have heater inspected yearly by a qualified service person (see Fig. 26).

We also recommend that you keep the burner tube and pilot assembly clean and free of dust and dirt. To clean these parts we recommend using compressed air no greater than 30 PSI. Your local computer store, hardware store, or home center may carry compressed air in a can. You can use a vacuum cleaner in the blow position. If using compressed air in a can, please follow the directions on the can. If you don't follow directions on the can, you could damage the pilot assembly.

1. Shut off the unit, including the pilot. Allow the unit to cool for at least thirty minutes.
2. Inspect burner, burner primary air holes on injector holder and pilot primary air inlets for dust and dirt (see Fig. 27).
3. Blow air through the ports and holes in the burner.
4. Check the injector holder located at the end of the burner tube again. Remove any large particles of dust, dirt, lint, or pet hair with a soft cloth or vacuum cleaner nozzle.
5. Blow air into the primary air holes on the injector holder.

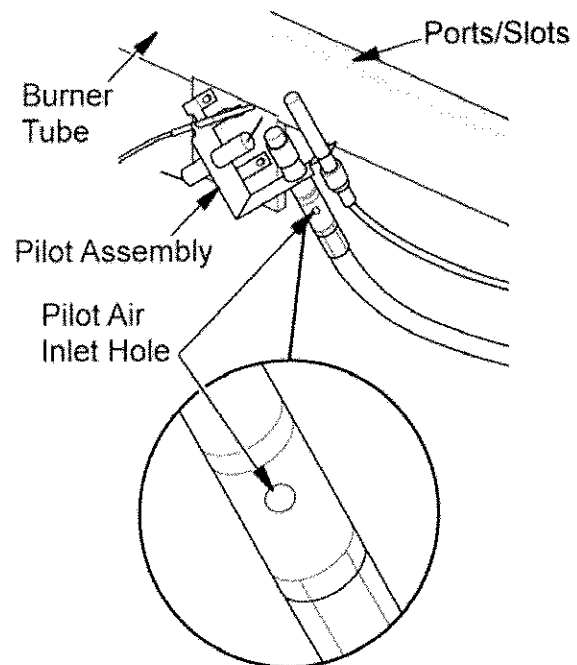

Figure 27 - Pilot Inlet Air Hole

Replace any screen or guard (heat shield or cover), before operating appliance.

TROUBLESHOOTING

Note: All troubleshooting items are listed in order of operation.

OBSERVED PROBLEM	POSSIBLE CAUSE	REMEDY
When ignitor button is pressed, there is no spark at ODS/pilot	1. Ignitor electrode not connected to ignitor cable	1. Reconnect ignitor cable
	2. Ignitor cable pinched or wet	2. Free ignitor cable if pinched by any metal or tubing. Keep ignitor cable dry
	3. Piezo ignitor nut is loose	3. Tighten nut holding piezo ignitor to base panel of log set. Nut is located behind base panel.
	4. Broken ignitor cable	4. Replace ignitor cable
	5. Bad piezo ignitor	5. Replace piezo ignitor
	6. Ignitor electrode positioned wrong	6. Replace ignitor
	7. Ignitor electrode broken	7. Replace ignitor
When ignitor button is pressed, there is spark at ODS/pilot but no ignition	1. Gas supply turned off or manual shutoff valve closed	1. Turn on gas supply or open manual shutoff valve
	2. Control knob not in PILOT position	2. Turn control knob to PILOT position
	3. Control knob not pressed in while in PILOT position	3. Press in control knob while in PILOT position
	4. Air in gas lines when installed	4. Continue holding down control knob. Repeat igniting operation until air is removed
	5. ODS/pilot is clogged	5. Clean ODS/pilot (see <i>Cleaning and Maintenance</i> , page 18) or replace ODS/pilot assembly
	6. Gas regulator setting is not correct	6. Replace gas regulator

TROUBLESHOOTING

Continued

OBSERVED PROBLEM	POSSIBLE CAUSE	REMEDY
ODS/pilot lights but flame goes out when control knob is released	<ol style="list-style-type: none"> Control knob not fully pressed in Control knob not pressed in long enough Safety interlock system has been triggered Manual shutoff valve not fully open Pilot flame not touching thermocouple, which allows thermocouple to cool, causing pilot flame to go out. This problem could be caused by one or both of the following: <ol style="list-style-type: none"> Low gas pressure Dirty or partially clogged ODS/pilot Thermocouple connection loose at control valve Thermocouple damaged Control valve damaged 	<ol style="list-style-type: none"> Press in control knob fully After ODS/pilot lights, keep control knob pressed in 30 seconds Wait one minute for safety interlock system to reset. Repeat ignition operation Fully open manual shutoff valve A) Contact local natural gas company B) Clean ODS/pilot (see <i>Cleaning and Maintenance</i>, page 18) or replace ODS/pilot assembly Hand tighten until snug, then tighten 1/4 turn more Replace thermocouple Replace control valve
Burner does not light after ODS/pilot is lit	<ol style="list-style-type: none"> Inlet gas pressure is too low Burner orifice clogged Thermopile leads disconnected or improperly connected (Remote-Ready Models Only) Burners will not come on in remote position (Remote-Ready Models Only) 	<ol style="list-style-type: none"> Contact local natural gas company Clean burner (see <i>Cleaning and Maintenance</i>, page 18) or replace burner orifice Reconnect leads (see <i>Wiring Diagram</i>, page 17) Replace battery in transmitter and receiver
Delayed ignition burner	<ol style="list-style-type: none"> Manifold pressure is too low Burner orifice clogged 	<ol style="list-style-type: none"> Contact local natural gas company Clean burner (see <i>Cleaning and Maintenance</i>, page 18) or replace burner orifice
Burner backfiring during combustion	<ol style="list-style-type: none"> Burner orifice is clogged or damaged Damaged burner Gas regulator defective 	<ol style="list-style-type: none"> Clean burner (see <i>Cleaning and Maintenance</i>, page 18) or replace burner orifice Replace damaged burner Replace gas regulator
Slight smoke or odor during initial operation	<ol style="list-style-type: none"> Not enough air Gas regulator defective Residues from manufacturing processes and logs curing 	<ol style="list-style-type: none"> Check burner for dirt and debris. If found, clean burner (see <i>Cleaning and Maintenance</i>, page 18) Replace gas regulator Problem will stop after a few hours of operation
Heater produces a whistling noise when burner is lit	<ol style="list-style-type: none"> Turning control knob to HI position when burner is cold Air in gas line Air passageways on heater blocked Dirty or partially clogged burner orifice 	<ol style="list-style-type: none"> Turn control knob to LO position and let warm up for a minute Operate burner until air is removed from line. Have gas line checked by local natural gas company Observe minimum installation clearances (see pages 7 through 9) Clean burners (see <i>Cleaning and Maintenance</i>, page 18) or replace burner orifice
Moisture/condensation noticed on windows	<ol style="list-style-type: none"> Not enough combustion/ventilation air 	<ol style="list-style-type: none"> Refer to <i>Air for Combustion and Ventilation</i> requirements (pages 4 through 6)

TROUBLESHOOTING

Continued



WARNING: If you smell gas

- Shut off gas supply.
- Do not try to light any appliance.
- Do not touch any electrical switch; do not use any phone in your building.
- Immediately call your gas supplier from a neighbor's phone. Follow the gas supplier's instructions.
- If you cannot reach your gas supplier, call the fire department.

IMPORTANT: Operating heater where impurities in air exist may create odors. Cleaning supplies, paint, paint remover, cigarette smoke, cements and glues, new carpet or textiles, etc., create fumes. These fumes may mix with combustion air and create odors. These odors will disappear over time.

OBSERVED PROBLEM	POSSIBLE CAUSE	REMEDY
Dark residue on logs or inside of fireplace	<ol style="list-style-type: none"> 1. Improper log placement 2. Drafts or other air currents affecting flame pattern 3. Air holes at burner inlet blocked 4. Burner flame holes blocked 	<ol style="list-style-type: none"> 1. Properly locate logs (see <i>Installing Logs</i>, page 11-12) 2. Eliminate source of drafts around heater 3. Clean out air holes at burner inlet. Periodically repeat as needed 4. Remove blockage or replace burner
White powder residue forming within burner box or on adjacent walls or furniture	<ol style="list-style-type: none"> 1. When heated, vapors from furniture polish, wax, carpet cleaners, etc. turn into white powder residue 	<ol style="list-style-type: none"> 1. Turn heater off when using furniture polish, wax, carpet cleaners, or similar products
Heater produces a clicking/ticking noise just after burner is lit or shut off	<ol style="list-style-type: none"> 1. Metal expanding while heating or contracting while cooling 	<ol style="list-style-type: none"> 1. This is common with most heaters. If noise is excessive, contact qualified service person
Heater produces unwanted odors	<ol style="list-style-type: none"> 1. Heater burning vapors from paint, hair spray, glues, cleaners, chemicals, new carpet, etc. (see <i>IMPORTANT</i> statement above) 2. Gas leak. See Warning statement at top of page 	<ol style="list-style-type: none"> 1. Open window and ventilate room. Stop using odor causing products while heater is running 2. Locate and correct all leaks (see <i>Checking Gas Connections</i>, page 9)
Heater shuts off in use (ODS operates)	<ol style="list-style-type: none"> 1. Not enough fresh air is available 2. Low line pressure 3. ODS/pilot is partially clogged 	<ol style="list-style-type: none"> 1. Open window and/or door for ventilation 2. Contact local natural gas company 3. Clean ODS/pilot (see <i>Cleaning and Maintenance</i>, page 18)
Gas odor even when control knob is in OFF position	<ol style="list-style-type: none"> 1. Gas leak. See Warning statement at top of page 2. Control valve defective 	<ol style="list-style-type: none"> 1. Locate and correct all leaks (see <i>Checking Gas Connections</i>, page 9) 2. Replace control valve
Gas odor during combustion	<ol style="list-style-type: none"> 1. Foreign matter between control valve and burner 2. Gas leak. See Warning statement at top of page 	<ol style="list-style-type: none"> 1. Take apart gas tubing and remove foreign matter 2. Locate and correct all leaks (see <i>Checking Gas Connections</i>, page 9)
Remote does not function (Remote-Ready Models Only)	<ol style="list-style-type: none"> 1. Battery is not installed. Battery power is low 	<ol style="list-style-type: none"> 1. Replace batteries in receiver and hand-held remote control

PARTS LIST & ILLUSTRATED PARTS BREAKDOWN

Model: VFM18,24,30

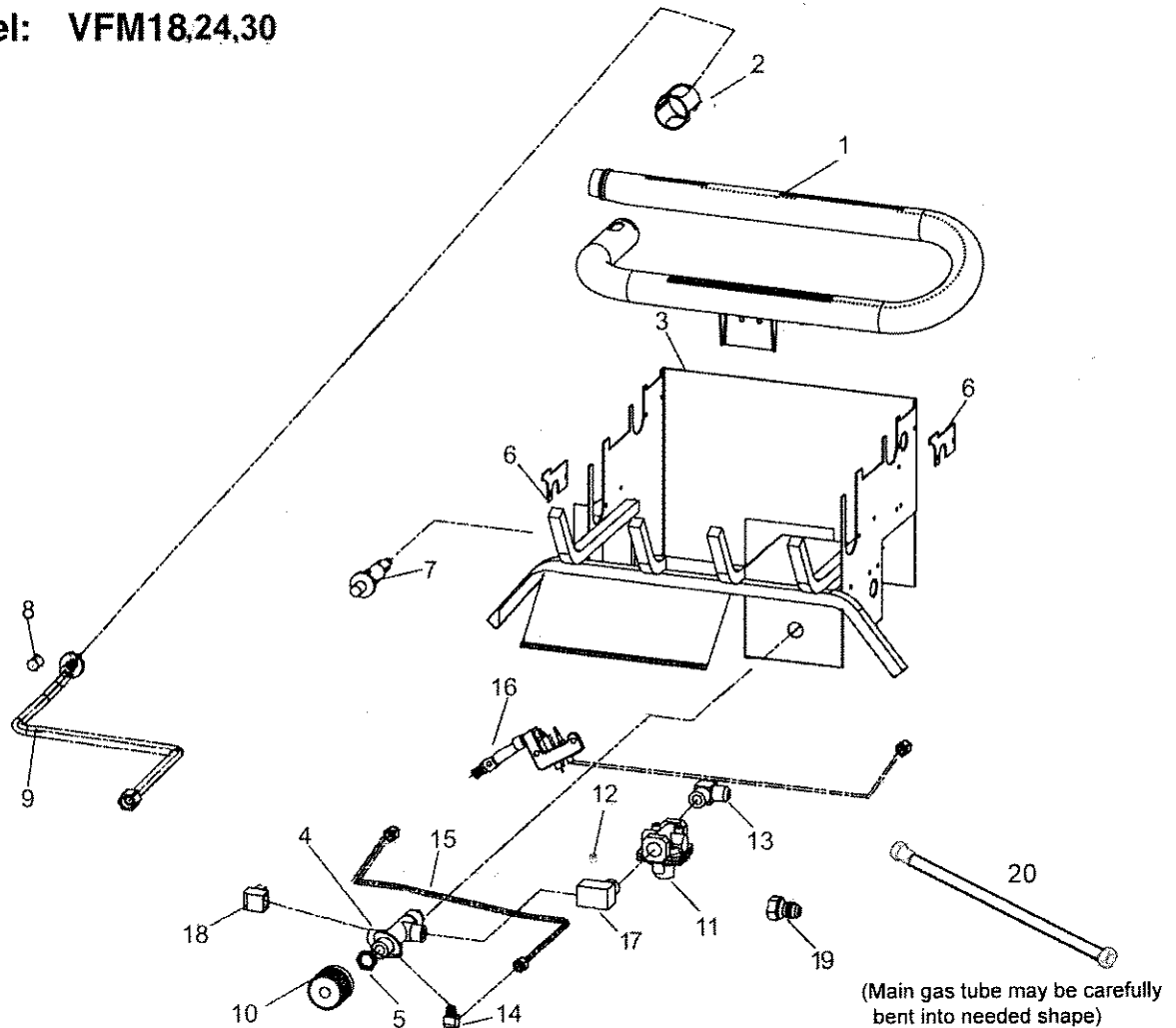

ITEM	DESCRIPTION	VFM18	VFM24	VFM30
1	Dual Burner	RMH-120-01120	RMH-120-01430	RMH-120-01430
2	Air Shutter NG	RMH-120-00260	RMH-120-00260	RMH-120-00260
2	Air Shutter LP	RMH-120-00252	RMH-120-00252	RMH-120-00252
3	FRAME GRATE BURNER ASSM.™	WIP-120-90530	WIP-120-90534	WIP-120-90534
4	Gas Valve, Manual	FCHD1809017	FCHD1809017	FCHD1809017
5	Nut, Gas Valve	RHWDZ00005A	RHWDZ00005A	RHWDZ00005A
6	Burner Support Clip	FCHD1809008	FCHD1809008	FCHD1809008
7	Piezo Igniter, Snap-In	RMH-120-90945	RMH-120-90945	RMH-120-90945
8	Orifice NG	RMH-120-SP033	RMH-120-SP018	RMH-120-SP018
8	Orifice LP	RMH-120-SP051	RMH-120-SP049	RMH-120-SP049
9	Orifice Tube, Main Burner	RMH-120-TCLOT18	RMH-120-TCLOT24	RMH-120-TCLOT24
10	Knob, Control Valve	FCHD1809018	FCHD1809018	FCHD1809018
11	Gas Regulator NG	RMH-120-00214	RMH-120-00214	RMH-120-00214
11	Gas Regulator LP	RMH-120-00213	RMH-120-00213	RMH-120-00213
12	Plug, Press Tap (1/8" Pipe)	FCHD2309031	FCHD2309031	FCHD2309031
13	Elbow, .25 FNPT X .5625 Flare	RMH-120-00032	RMH-120-00032	RMH-120-00032
14	Elbow, .125 FNPT X .125 Comp	FCHD1809015	FCHD1809015	FCHD1809015
15	Tube, Control Valve to ODS	FCHD1809016	FCHD1809016	FCHD1809016
16	ODS Pilot NG	RMH-120-08221	RMH-120-08221	RMH-120-08221
16	ODS Pilot LP	RMH-120-08418	RMH-120-08418	RMH-120-08418
17	Elbow, .375 FNPT X .375 FNPT	FCHD1809020	FCHD1809020	FCHD1809020
18	Elbow, .375 FNPT X .625 MUNEF	FCHD2409014	FCHD2409014	FCHD2409014
19	Adapter, .375 FNPT X .5625 Flare	FCHD1809021	FCHD1809021	FCHD1809021
20	Tube, Main Gas Supply	WIP-120-90414	WIP-120-90414	WIP-120-90414

PARTS LIST & ILLUSTRATED PARTS BREAKDOWN

Model: BIVFMV 18,24,30

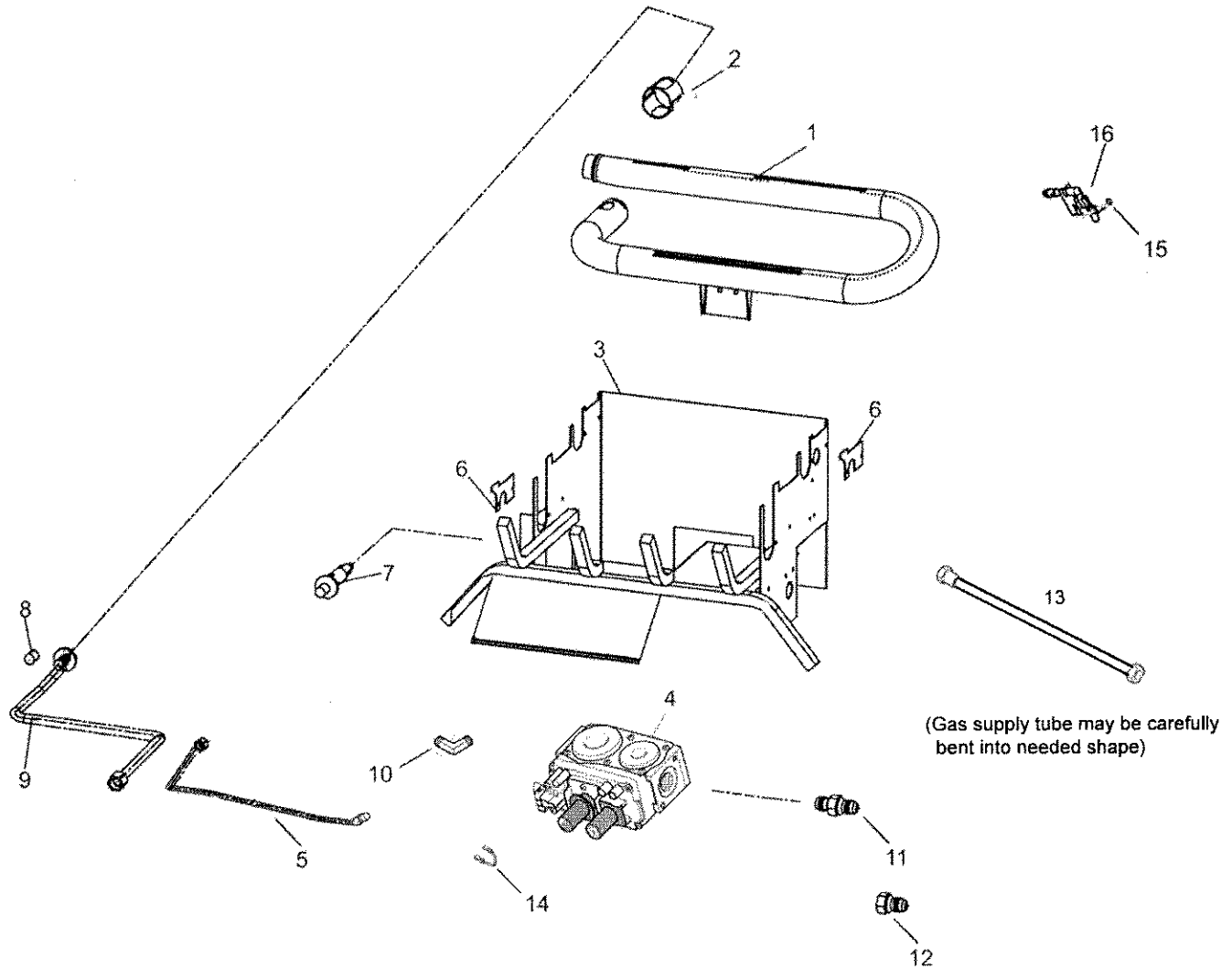

(Gas supply tube may be carefully bent into needed shape)

ITEM	DESCRIPTION	QUANTITY	BIVFMV18	BIVFMV24	BIVFMV30
1	Dual Burner	1	RMH-120-01120	RMH-120-01430	RMH-120-01430
2	Air Shutter NG	1	RMH-120-00260	RMH-120-00260	RMH-120-00260
2	Air Shutter LP	1	RMH-120-00252	RMH-120-00252	RMH-120-00252
3	FRAME GRATE BURNER ASSM. ""	1	WIP-120-90530	WIP-120-90534	WIP-120-90534
4	Gas Valve, mV NG	1	RMH-120-00547	RMH-120-00547	RMH-120-00547
4	Gas Valve, mV LP	1	RMH-120-00544	RMH-120-00544	RMH-120-00544
5	Tube, Control Valve to ODS	1	WIP-120-90432	WIP-120-90432	WIP-120-90432
6	Burner Support Clip	2	FCHD1809008	FCHD1809008	FCHD1809008
7	Piezo Igniter with nut	1	RMH-120-90945	RMH-120-90945	RMH-120-90945
8	Orifice NG	1	RMH-120-SP033	RMH-120-SP018	RMH-120-SP018
8	Orifice LP	1	RMH-120-SP051	RMH-120-SP049	RMH-120-SP049
9	Orifice Tube, Main Burner	1	RMH-120-09003	RMH-120-09003	RMH-120-09003
9	Orifice Tube, Main Burner	1	RMH-120-09004	RMH-120-09004	RMH-120-09004
10	Elbow, .375 MNPT X .375 Flare	1	RMH-120-00062	RMH-120-00062	RMH-120-00062
11	Adapter, .375 MNPT X .5625 Flare	1	RMH-120-00050	RMH-120-00050	RMH-120-00050
12	Adapter, .375 FNPT X .5625 Flare	1	FCHD1809021	FCHD1809021	FCHD1809021
13	Tube, Main Gas Supply	1	WIP-120-90414	WIP-120-90414	WIP-120-90414
14	Jumper Wire	1	WIP-722-00003	WIP-722-00003	WIP-722-00003
15	Nut, ODS Mounting	2	RMP-122-0062	RMP-122-0062	RMP-122-0062
16	ODS Pilot NG	1	RMH-120-008419	RMH-120-008419	RMH-120-008419
16	ODS Pilot LP	1	RMH-120-008421	RMH-120-008421	RMH-120-008421

SERVICE INFORMATION

REPLACEMENT PARTS

Note: Use only original replacement parts. This will protect your warranty coverage for parts replaced under warranty.

Parts Under Warranty

Contact authorized dealers of this product. If they can't supply original replacement part(s), call SHM International's Technical Service Department at (800) 229-5647.

When calling SHM International, have ready:

- your name
- your address
- model and serial numbers of your heater
- how heater was malfunctioning
- type of gas used (propane/LP or natural gas)
- purchase date

Usually, we will ask you to return the part to the factory.

Parts Not Under Warranty

Contact authorized dealers of this product. If they can't supply original replacement part(s), call SHM International at (800) 229-5647 for referral information. When calling SHM International, have ready:

- model number of your heater
- the replacement part number (see *Page 23-24*)

SERVICE HINTS

When gas pressure is too low:

- pilot will not stay lit
- heater will not produce the specified heat
- propane/LP gas supply may be low

You may feel your gas pressure is too low. If so, contact your local natural or propane/LP gas supplier.

Note: Use only original replacement parts. This will protect your warranty coverage for parts replaced under warranty.

TECHNICAL SERVICE

You may have further questions about installation, operation or troubleshooting. If so, contact SHM International's Technical Service Department at (800) 229-5647.

When calling please have your model and serial numbers of your heater ready. You can also visit SHM International's Technical Service web site at www.sureheat.com.

SPECIFICATIONS

Model (S,B)	VFM18NG	VFM18LP	VFM21,24NG	VFM21,24LP	VFM27,30NG	VFM27,30LP
Gas Type	Natural Gas	Propane/LP	Natural Gas	Propane/LP	Natural Gas	Propane/LP
Input Max.	34,000 BTU/Hr	34,000 BTU/Hr	39,000 BTU/Hr	39,000 BTU/Hr	39,000 BTU/Hr	39,000 BTU/Hr
Input Min.	22,000 BTU/Hr	22,000 BTU/Hr	22,000 BTU/Hr	22,000 BTU/Hr	22,000 BTU/Hr	22,000 BTU/Hr
Manifold Pressure	3.5" W.C.	8.0" W.C.	3.5" W.C.	8.0" W.C.	3.5" W.C.	8.0" W.C.
Inlet Pressure Max.	10.5" W.C.	14.0" W.C.	10.5" W.C.	14.0" W.C.	10.5" W.C.	14.0" W.C.
Inlet Pressure Min.*	7.0" W.C.	11.0" W.C.	7.0" W.C.	11.0" W.C.	7.0" W.C.	11.0" W.C.
Min. Firebox Size	18" H X 22" W X 12" D		18" H X 28" W X 15" D		18" H X 34" W X 15" D	
Model (S,B)	IVFMV18NG	IVFMV18LP	IVFMV21,24NG	IVFMV21,24LP	IVFMV27,30NG	IVFMV27,30LP
Gas Type	Natural Gas	Propane/LP	Natural Gas	Propane/LP	Natural Gas	Propane/LP
Input Max.	34,000 BTU/Hr	34,000 BTU/Hr	39,000 BTU/Hr	39,000 BTU/Hr	39,000 BTU/Hr	39,000 BTU/Hr
Input Min.	22,000 BTU/Hr	22,000 BTU/Hr	22,000 BTU/Hr	22,000 BTU/Hr	22,000 BTU/Hr	22,000 BTU/Hr
Manifold Pressure	3.5" W.C.	8.0" W.C.	3.5" W.C.	8.0" W.C.	3.5" W.C.	8.0" W.C.
Inlet Pressure Max.	10.5" W.C.	14.0" W.C.	10.5" W.C.	14.0" W.C.	10.5" W.C.	14.0" W.C.
Inlet Pressure Min.*	7.0" W.C.	11.0" W.C.	7.0" W.C.	11.0" W.C.	7.0" W.C.	11.0" W.C.
Min. Firebox Size	18" H X 22" W X 12" D		18" H X 28" W X 15" D		18" H X 34" W X 15" D	

*For purpose of input adjustment

WARRANTY INFORMATION

KEEP THIS WARRANTY

Model _____
Serial No. _____
Date Purchased _____

Always specify model and serial numbers when communicating with the factory.

LIMITED WARRANTY

SHM International Corp. warrants the components of this appliance to be free from defects in material and workmanship for one (1) year from the date of purchase. SHM International Corp. at its option, will repair or replace this product or any component of the product found to be defective during the warranty period. Replacement will be made with a new manufactured product or component. If the product is no longer available, replacement may be made with a similar product of equal value. This warranty does not include transportation or shipping costs of any kind. This your exclusive warranty.

This warranty is valid for the original retail purchaser from the date of initial retail purchase and is not transferable. Keep the original sales receipt. Proof of purchase is required to obtain warranty parts.

This warranty does not cover normal wear of parts such as scratches and dents of the components or damage resulting from any of the following:

- negligent use or misuse of the product, including exposing the product to chemicals or cleaning products not approved by SHM International Corp.
- corrosion, rust or discoloring of any kind
- use or installation contrary to specified instructions and applicable building codes, including heating the product to temperatures above its rated specifications which can cause considerable warping
- disassembly, including removal of the product from a built-in installation
- damage resulting from accident, alteration, misuse, abuse, hostile environments, or improper installation
- repair or alteration
- acts of God, such as fire, flood, hurricanes, and tornadoes
- gas cylinders, propane tanks or other fuel delivery systems, including connections to a household fuel supply
- usage other than single-family household use such as commercial or industrial use
- minor warping or discoloration of parts, which is normal and not a defect under this warranty

DO NOT RETURN THIS PRODUCT TO THE PLACE OF PURCHASE

If the appliance does not operate properly, first thoroughly carry out the instructions provided with the unit to ensure that the appliance is installed correctly and check the troubleshooting section in the use and care manual.

We recommend you return the warranty registration card so that you can be contacted when any questions of safety arise that could affect you. The return of the warranty registration card is not a condition for warranty coverage.

Because of continuing product improvement, these specifications are subject to change without notice.

If you have other questions or need replacement parts, contact our
Customer Service Hotline at (800) 229-5647 or
visit our website at www.sureheat.com.

SHM International Corp., 1861 West Oak Parkway, Marietta, GA 30062