

Exhibit No.:
Issue: Rate Design
Witness: Maurice Brubaker
Type of Exhibit: Direct Testimony
Sponsoring Parties: Industrials
Case No.: ER-2010-0356
Date Testimony Prepared: December 1, 2010

**BEFORE THE PUBLIC SERVICE
COMMISSION OF THE STATE OF MISSOURI**

_____)
In the Matter of the Application of)
KCP&L Greater Missouri Operations)
Company for Approval to Make) **Case No. ER-2010-0356**
Certain Changes in its Charges for)
Electric Service)
_____)

Direct Testimony and Schedules of

Maurice Brubaker

On behalf of

**Ag Processing, Inc.
Sedalia Industrial Energy Users Association
Federal Executive Agencies**

December 1, 2010

1406
~~1406~~
~~003~~
Industrials Exhibit No. ~~003~~ **BAI**
Date 1/18/11 Reporter LMB BRUBAKER & ASSOCIATES, INC.
File No. ER-2010-0356 CHESTERFIELD, MO 63017
Project 9216

**BEFORE THE PUBLIC SERVICE
COMMISSION OF THE STATE OF MISSOURI**

In the Matter of the Application of KCP&L Greater Missouri Operations Company for Approval to Make Certain Changes in its Charges for Electric Service)))))))))	Case No. ER-2010-0356
--	---	-----------------------

STATE OF MISSOURI)
)
) SS
COUNTY OF ST. LOUIS)

Affidavit of Maurice Brubaker

Maurice Brubaker, being first duly sworn, on his oath states:

1. My name is Maurice Brubaker. I am a consultant with Brubaker & Associates, Inc., having its principal place of business at 16690 Swingley Ridge Road, Suite 140, Chesterfield, Missouri 63017. We have been retained by Ag Processing, Inc., Sedalia Industrial Energy Users Association and Federal Executive Agencies in this proceeding on their behalf.

2. Attached hereto and made a part hereof for all purposes is my direct testimony and schedules which were prepared in written form for introduction into evidence in the Missouri Public Service Commission's Case No. ER-2010-0356.

3. I hereby swear and affirm that the testimony and schedules are true and correct and that they show the matters and things that they purport to show.

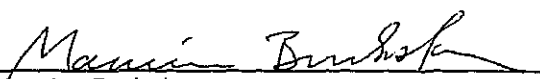
 Maurice Brubaker

Subscribed and sworn to before me this 30th day of November, 2010.

TAMMY S. KLOSSNER Notary Public - Notary Seal STATE OF MISSOURI St. Charles County My Commission Expires: Mar. 14, 2011 Commission # 07024862

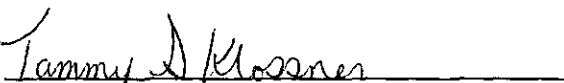
 Notary Public

**BEFORE THE PUBLIC SERVICE
COMMISSION OF THE STATE OF MISSOURI**

_____))
In the Matter of the Application of))
KCP&L Greater Missouri Operations))
Company for Approval to Make))
Certain Changes in its Charges for))
Electric Service))
_____)

Case No. ER-2010-0356

Direct Testimony of Maurice Brubaker

1 **Q PLEASE STATE YOUR NAME AND BUSINESS ADDRESS.**

2 A Maurice Brubaker. My business address is 16690 Swingley Ridge Road, Suite 140,
3 Chesterfield, MO 63017.

4 **Q WHAT IS YOUR OCCUPATION?**

5 A I am a consultant in the field of public utility regulation and President of Brubaker &
6 Associates, Inc., energy, economic and regulatory consultants.

7 **Q PLEASE DESCRIBE YOUR EDUCATIONAL BACKGROUND AND EXPERIENCE.**

8 A This information is included in Appendix A to my testimony.

9 **Q ON WHOSE BEHALF ARE YOU APPEARING IN THIS PROCEEDING?**

10 A I am appearing on behalf of Ag Processing, Inc., Sedalia Industrial Energy Users
11 Association and Federal Executive Agencies (collectively "Industrials"). These
12 customers purchase substantial amounts of electricity from KCP&L Greater Missouri
13 Operations Company ("GMO"), both in the MPS territory and in the L&P territory. The
14 outcome of this proceeding will have an impact on their cost of electricity.

**Maurice Brubaker
Page 1**

1 **Q WHAT IS THE PURPOSE OF YOUR TESTIMONY?**

2 A The purpose of my testimony is to present the results of a class cost of service study
3 for MPS and L&P, to explain how the study should be used, to recommend an
4 appropriate allocation of any rate increase, and to make rate design
5 recommendations.

6 **Q HOW IS YOUR TESTIMONY ORGANIZED?**

7 A First, I present an overview of cost of service principles and concepts. This includes
8 a description of how electricity is produced and distributed as well as a description of
9 the various functions that are involved; namely, generation, transmission and
10 distribution. This is followed by a discussion of the typical classification of these
11 functionalized costs into demand-related costs, energy-related costs and
12 customer-related costs.

13 With this as a background, I then explain the various factors which should be
14 considered in determining how to allocate these functionalized and classified costs
15 among customer classes.

16 Finally, I present the results of the detailed cost of service analyses for MPS
17 and L&P. Because of the similarity of the issues, and in order to avoid unnecessary
18 repetition, I will discuss these issues primarily in the context of MPS. The same
19 principles apply to L&P. I have created two sets of schedules, one set designated as
20 "MPS" and the other set designated as "L&P." The cost studies indicate how
21 individual customer class revenues compare to the costs incurred in providing service
22 to them. This analysis and interpretation is then followed by recommendations with
23 respect to the alignment of class revenues with class costs.

Maurice Brubaker
Page 2

1 **Summary**

2 **Q PLEASE SUMMARIZE YOUR TESTIMONY AND RECOMMENDATIONS.**

3 **A** My testimony and recommendations may be summarized as follows:

- 4 1. Class cost of service is the starting point and most important guideline for
5 establishing the level of rates charged to customers.
- 6 2. GMO exhibits significant summer peak demands as compared to demands in
7 other months, although L&P also has a fairly large winter peak as well.
- 8 3. There are two generally accepted methods for allocating generation and
9 transmission fixed costs that would apply to GMO. These are the coincident
10 peak methodology and the average and excess ("A&E") methodology.
- 11 4. The A&E methodology appropriately considers both class maximum demands
12 and class load factor, as well as diversity between class peaks and the system
13 peak.
- 14 5. In order to better reflect cost-causation, I have changed GMO's submitted cost of
15 service methodology in two respects:
- 16 (1) For generation fixed costs, GMO has used an obscure and inappropriate
17 method to allocate generation fixed costs, which I will address in my
18 rebuttal testimony. I have, instead, applied main-stream methods that this
19 Commission has previously endorsed.
- 20 (2) GMO has allocated off-system sales revenue using fixed cost allocation
21 factors. An energy allocation factor, as previously approved by this
22 Commission, should be used instead.
- 23 6. The results of my class cost of service study, incorporating the changes in
24 methodology that I have applied, are summarized on Schedule MEB-COS-4.
25 Schedule MEB-COS-5 shows the adjustments required to move each class to its
26 cost of service on a revenue neutral basis at present rates.
- 27 7. A modest realignment of class revenues to move them closer to costs should be
28 implemented, as presented on Schedule MEB-COS-6.

1

COST OF SERVICE PROCEDURES

Overview

3 **Q PLEASE DESCRIBE THE COST ALLOCATION PROCESS.**

4 A The objective of *cost allocation* is to determine what proportion of the utility's total
5 revenue requirement should be recovered from each customer class. As an aid to
6 this determination, cost of service studies are usually performed to determine the
7 portions of the total costs that are incurred to serve each customer class. The cost of
8 service study identifies the cost responsibility of the class and provides the foundation
9 for revenue allocation and rate design. For many regulators, cost-based rates are an
10 expressed goal. To better interpret cost allocation and cost of service studies, it is
11 important to understand the production and delivery of electricity.

Electricity Fundamentals

13 **Q IS ELECTRICITY SERVICE LIKE ANY OTHER GOODS OR SERVICES?**

14 A No. Electricity is different from most other goods or services purchased by
15 consumers. For example:

- 16 ▪ It cannot be stored; must be delivered as produced;
- 17 ▪ It must be delivered to the customer's home or place of business;
- 18 ▪ The delivery occurs instantaneously when and in the amount needed by the
19 customer; and
- 20 ▪ Both the total quantity used (energy or kWh) by a customer and the rate of use
21 (demand or kW) are important.

22 These unique characteristics differentiate electric utilities from other service-related
23 industries.

24 The service provided by electric utilities is multi-dimensional. First, unlike
25 most vital services, electricity must be delivered at the place of consumption – homes,

Maurice Brubaker
Page 4

1 schools, businesses, factories – because this is where the lights, appliances,
2 machines, air conditioning, etc. are located. Thus, every utility must provide a path
3 through which electricity can be delivered regardless of the customer's **demand** and
4 **energy** requirements at any point in time.

5 Even at the same location, electricity may be used in a variety of applications.
6 Homeowners, for example, use electricity for lighting, air conditioning, perhaps
7 heating, and to operate various appliances. At any instant, several appliances may
8 be operating (e.g., lights, refrigerator, TV, air conditioning, etc.). Which appliances
9 are used and when reflects the second dimension of utility service – the rate of
10 electricity use or **demand**. The demand imposed by customers is an especially
11 important characteristic because the maximum demands determine how much
12 capacity the utility is obligated to provide.

13 Generating units, transmission lines and substations and distribution lines and
14 substations are rated according to the maximum demand that can safely be imposed
15 on them. (They are not rated according to average annual demand; that is, the
16 amount of energy consumed during the year divided by 8,760 hours.) On a hot
17 summer afternoon when customers demand 2,000 MW of electricity, the utility must
18 have at least 2,000 MW of generation, plus additional capacity to provide adequate
19 reserves, so that when a consumer flips the switch, the lights turn on, the machines
20 operate and air conditioning systems cool our homes, schools, offices, and factories.

21 Satisfying customers' demand for electricity over time – providing **energy** – is
22 the third dimension of utility service. It is also the dimension with which many people
23 are most familiar, because people often think of electricity simply in terms of kWhs.
24 To see one reason why this isn't so, consider a more familiar commodity – tomatoes,
25 for example.

1 The tomatoes we buy at the supermarket for about \$2.00 a pound might
2 originally come from Florida where they are bought for about 30¢ a pound. In
3 addition to the cost of buying them at the point of production, there is the cost of
4 bringing them to the state of Missouri and distributing them in bulk to local
5 wholesalers. The cost of transportation, insurance, handling and warehousing must
6 be added to the original 30¢ a pound. Then they are distributed to neighborhood
7 stores, which adds more handling costs as well as the store's own costs of light, heat,
8 personnel and rent. Shoppers can then purchase as many or few tomatoes as they
9 desire at their convenience. In addition, there are losses from spoilage and damage
10 in handling. These "line losses" represent an additional cost which must be
11 recovered in the final price. What we are really paying for at the store is not only the
12 vegetable itself, but the service of having it available in convenient amounts and
13 locations. If we took the time and trouble (and expense) to go down to the wholesale
14 produce distributor, the price would be less. If we could arrange to buy them in bulk
15 in Florida, they would be even cheaper .

16 As illustrated in Figure 1, electric utilities are similar, except that in most cases
17 (including Missouri), a single company handles everything from production on down
18 through wholesale (bulk and area transmission) and retail (distribution to homes and
19 stores). The crucial difference is that, unlike producers and distributors of tomatoes,
20 electric utilities have an obligation to provide continuous reliable service. The
21 obligation is assumed in return for the exclusive right to serve all customers located
22 within its territorial franchise. In addition to satisfying the energy (or kWh)
23 requirements of its customers, the obligation to serve means that the utility must also
24 provide the necessary facilities to attach customers to the grid (so that service can be

- 1 used at the point where it is to be consumed) and these facilities must be responsive
- 2 to changes in the kilowatt demands whenever they occur.

Figure 1
PRODUCTION AND DELIVERY OF ELECTRICITY

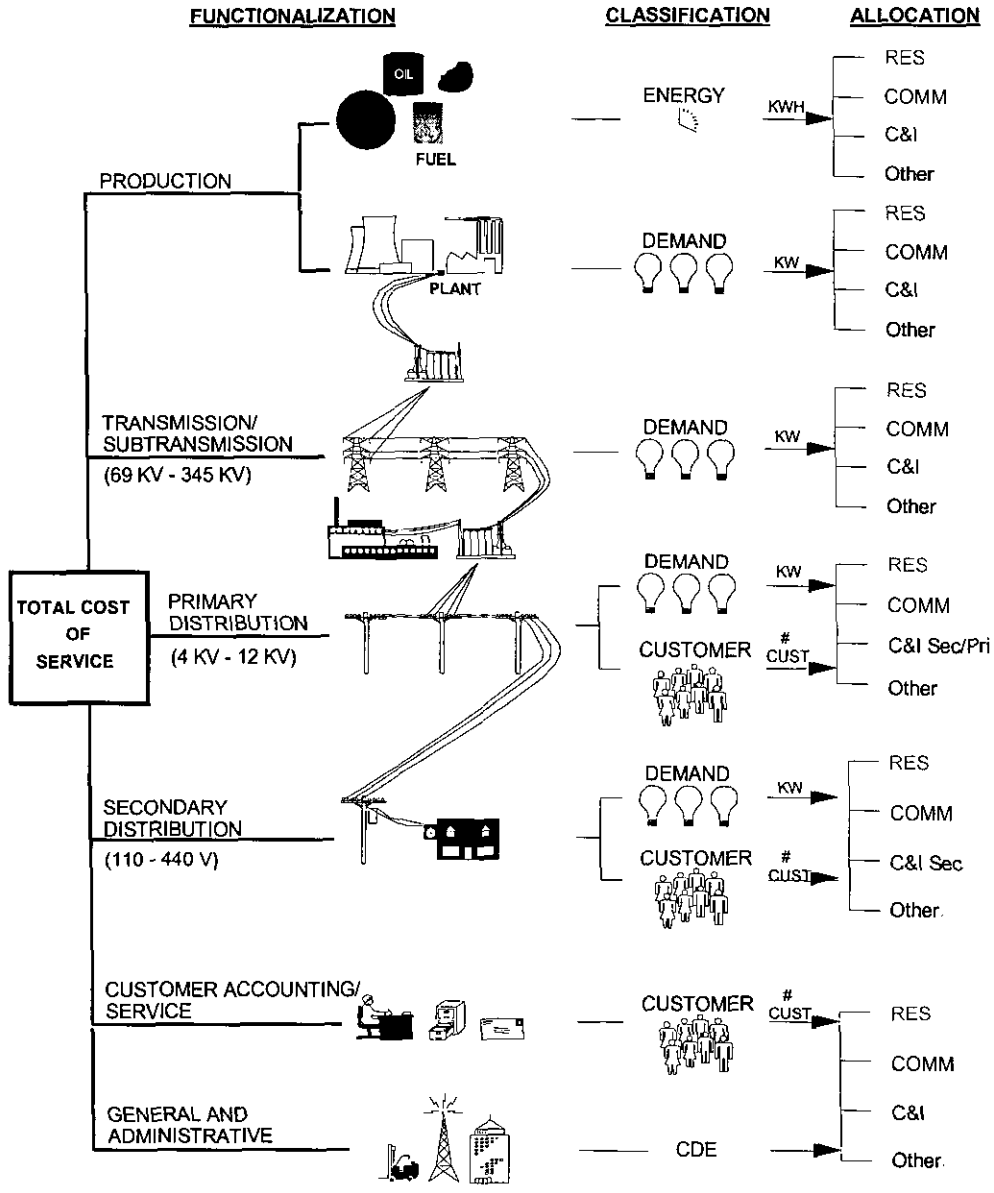

1 **A CLOSER LOOK AT THE COST OF SERVICE STUDY**

2 **Q PLEASE EXPLAIN HOW A COST OF SERVICE STUDY IS PREPARED.**

3 **A To the extent possible, the unique characteristics that differentiate electric utilities**
4 from other service-related industries should be recognized in determining the cost of
5 providing service to each of the various customer classes. The basic procedure for
6 conducting a class cost of service study is simple. In an allocated cost of service
7 study, we identify the different types of costs (**functionalization**), determine their
8 primary causative factors (**classification**) and then apportion each item of cost
9 among the various rate classes (**allocation**). Adding up the individual pieces gives
10 the total cost for each customer class.

11 **Functionalization**

12 **Q PLEASE EXPLAIN FUNCTIONALIZATION.**

13 **A Identifying the different levels of operation is a process referred to as**
14 **functionalization.** The utility's investment and expenses are separated by function
15 (production, transmission, etc.). To a large extent, this is done in accordance with the
16 Uniform System of Accounts.

17 Referring to Figure 1, at the top level there is generation. The next level is the
18 extra high voltage transmission and subtransmission system (69,000 volts to 345,000
19 volts). Then the voltage is stepped down to primary voltage levels of distribution –
20 4,160 to 12,000 volts. Finally, the voltage is stepped down by pole transformers at
21 the "secondary" level to 110-440 volts used to serve homes, barbershops, light
22 manufacturing and the like. Additional investment and expenses are required to
23 serve customers at secondary voltages, compared to the cost of serving customers at
24 higher voltage.

1 Each additional transformation, thus, requires additional investment, additional
2 expenses and results in some additional electrical losses. To say that "a kilowatthour
3 is a kilowatthour" is like saying that "a tomato is a tomato." It's true in one sense, but
4 when you buy a kWh at home you're not only buying the energy itself but also the
5 service of having it delivered right to your doorstep in convenient form. Those who
6 buy at the bulk or wholesale level – like Large Transmission and Large Primary
7 service customers – pay less because some of the expenses to the utility are
8 avoided. (Actually, the expenses are borne by the customer who must invest in his
9 own transformers and other equipment, or pay separately for some services.)

10 **Classification**

11 **Q WHAT IS CLASSIFICATION?**

12 **A**Once the costs have been functionalized, the next step is to identify the primary
13 causative factor (or factors). This step is referred to as **classification**. Costs are
14 classified as demand-related, energy-related or customer-related.

15 Looking at the production function, the amount of production plant capacity
16 required is primarily determined by the peak rate of usage during the year. If the
17 utility anticipates a peak demand of 2,000 MW – it must install and/or contract for
18 enough generating capacity to meet that anticipated demand (plus some reserve to
19 compensate for variations in load and capacity that is temporarily unavailable).

20 There will be many hours during the day or during the year when not all of this
21 generating capacity will be needed. Nevertheless, it must be in place to meet the
22 peak demands on the system. Thus, production plant investment is usually classified
23 to demand. **Regardless of how production plant investment is classified, the**
24 **associated capital costs** (which include return on investment, depreciation, fixed

1 operation and maintenance ("O&M") expenses, taxes and insurance) **are fixed**; that
2 is, **they do not vary with the amount of kWhs generated and sold**. These fixed
3 costs are determined by the amount of capacity (i.e., kilowatts) which the utility must
4 install to satisfy its obligation-to-serve requirement.

5 On the other hand, it is easy to see that the amount of fuel burned – and
6 therefore the amount of fuel expense – is closely related to the amount of energy
7 (number of kWhs) that customers use. Therefore, fuel expense is an energy-related
8 cost.

9 Most other O&M expenses are fixed and therefore are classified as
10 demand-related. Variable O&M expenses are classified as energy-related.
11 Demand-related and energy-related types of operating costs are not impacted by the
12 number of customers served.

13 Customer-related costs are the third major category. Obvious examples of
14 customer-related costs include the investment in meters and service drops (the line
15 from the pole to the customer's facility or house). Along with meter reading, posting
16 accounts and rendering bills, these "customer costs" may be several dollars per
17 customer, per month. Less obvious examples of customer-related costs may include
18 the investment in other distribution accounts.

19 A certain portion of the cost of the distribution system – poles, wires and
20 transformers – is required simply to attach customers to the system, regardless of
21 their demand or energy requirements. This minimum or "skeleton" distribution system
22 may also be considered a customer-related cost since it depends primarily on the
23 number of customers, rather than demand or energy usage.

24 Figure 2, as an example, shows the distribution network for a utility with two
25 customer classes, A and B. The physical distribution network necessary to attach

1 Class A is designed to serve 12 customers, each with a 10-kilowatt load, having a
2 total demand of 120 kW. This is the same total demand as is imposed by Class B,
3 which consists of a single customer. Clearly, a much more extensive distribution
4 system is required to attach the multitude of small customers (Class A), than to attach
5 the single larger customer (Class B), despite the fact that the total demand of each
6 customer class is the same.

7 Even though some additional customers can be attached without additional
8 investment in some areas of the system, it is obvious that attaching a large number of
9 customers requires investment in facilities, not only initially but on a continuing basis
10 as a result of the need for maintenance and repair.

11 To the extent that the distribution system components must be sized to
12 accommodate additional load beyond the minimum, the balance is a demand-related
13 cost. Thus, the distribution system is classified as both demand-related and
14 customer-related.

Figure 2
Classification of Distribution Investment

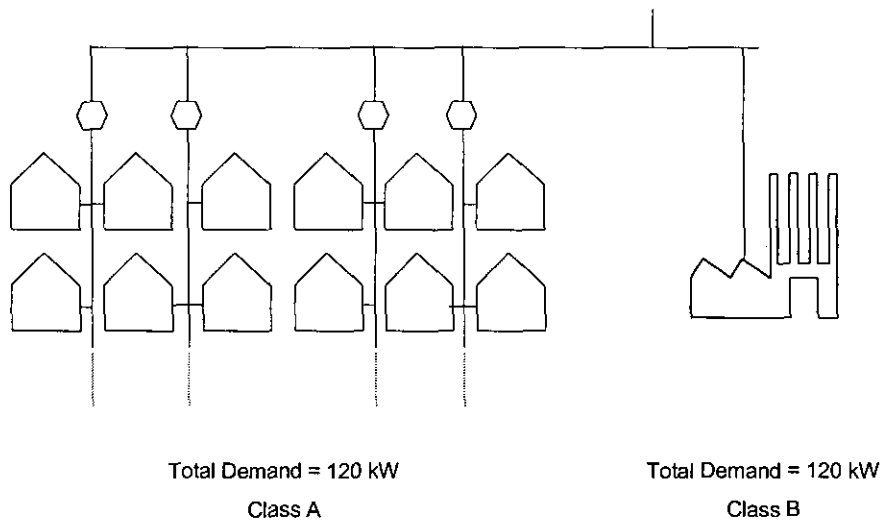

1 **Demand vs. Energy Costs**

2 **Q WHAT IS THE DISTINCTION BETWEEN DEMAND-RELATED COSTS AND**
3 **ENERGY-RELATED COSTS?**

4 **A** The difference between demand-related and energy-related costs explains the fallacy
5 of the argument that "a kilowatthour is a kilowatthour." For example, Figure 3
6 compares the electrical requirements of two customers, A and B, each using 100-watt
7 light bulbs.

8 Customer A turns on all five of his/her 100-watt light bulbs for two hours.
9 Customer B, by contrast, turns on two light bulbs for five hours. Both customers use
10 the same amount of energy – 1,000 watthours or 1 kWh. However, Customer A
11 utilized electric power at a higher rate, 500 watts per hour or 0.5 kW, than Customer
12 B who demanded only 200 watts per hour or 0.2 kW.

13 Although both customers had precisely the same kWh energy usage,
14 Customer A's kW demand was 2.5 times Customer B's. Therefore, the utility must
15 install 2.5 times as much generating capacity for Customer A as for Customer B. The
16 cost of serving Customer A, therefore, is much higher.

17 **Q DOES THIS HAVE ANYTHING TO DO WITH THE CONCEPT OF LOAD FACTOR?**

18 **A** Yes. Load factor is an expression of how uniformly a customer uses energy. In our
19 example of the light bulbs, the load factor of Customer B would be higher than the
20 load factor of Customer A because the use of electricity was spread over a longer
21 period of time, and the number of kWhs used for each kilowatt of demand imposed on
22 the system is much greater in the case of Customer B.

Figure 3

DEMAND VS. ENERGY

CUSTOMER A

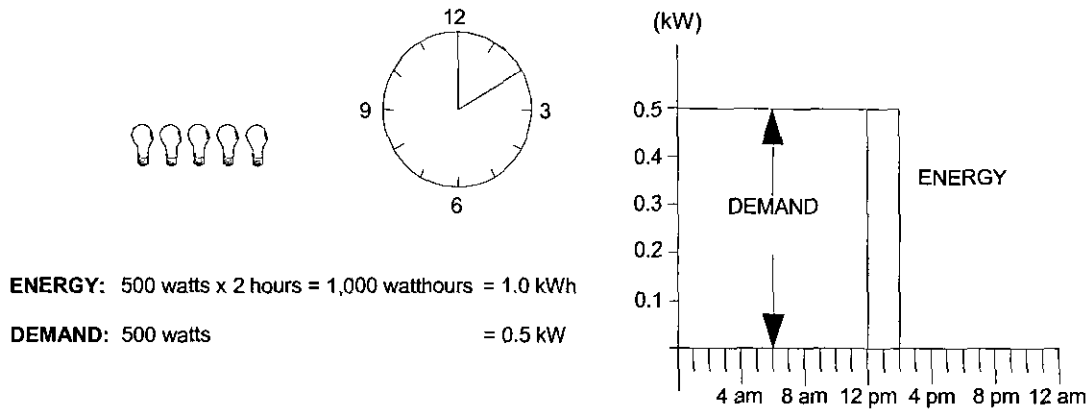

CUSTOMER B

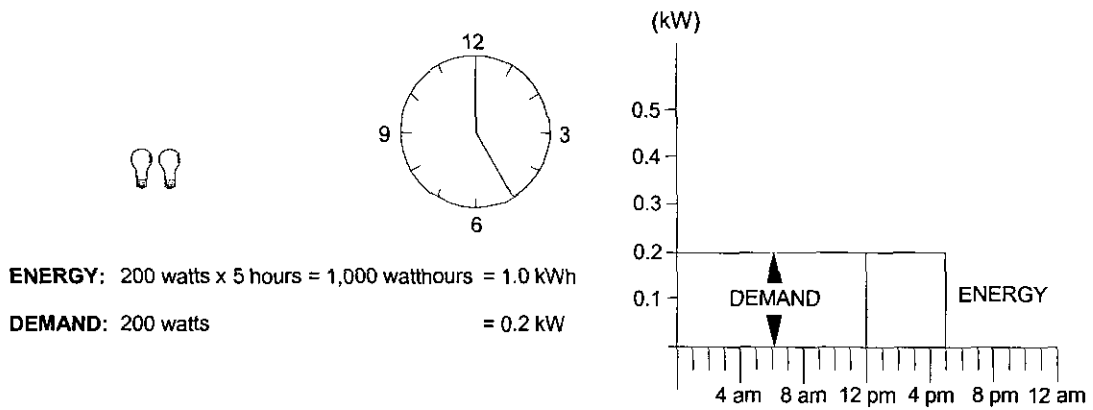

1 Mathematically, load factor is the average rate of use divided by the peak rate
2 of use. A customer with a higher load factor is less expensive to serve, on a per kWh
3 basis, than a customer with a low load factor, irrespective of size.

4 Consider also the analogy of a rental car which costs \$40/day and 20¢/mile. If
5 Customer A drives only 20 miles a day, the average cost will be \$2.20/mile. But for
6 Customer B, who drives 200 miles a day, spreading the daily rental charge over the
7 total mileage gives an average cost of 40¢/mile. For both customers, the fixed cost
8 rate (daily charge) and variable cost rate (mileage charge) are identical, but the
9 average total cost per mile will differ depending on how intensively the car is used.
10 Likewise, the average cost per kWh will depend on how intensively the generating
11 plant is used. A low load factor indicates that the capacity is idle much of the time; a
12 high load factor indicates a more steady rate of usage. Since industrial customers
13 generally have higher load factors than residential or commercial customers, they are
14 less costly to serve on a per-kWh basis. Again, we can say that "a kilowatthour is a
15 kilowatthour" as to energy content, but there may be a big difference in how much
16 generating plant investment is required to convert the raw fuel into electric energy.

17 Allocation

18 **Q WHAT IS ALLOCATION?**

19 **A** The final step in the cost of service analysis is the **allocation** of the costs to the
20 customer classes. Demand, energy and customer allocation factors are developed to
21 apportion the costs among the customer classes. Each factor measures the
22 customer class's contribution to the system total cost.

23 For example, we have already determined that the amount of fuel expense on
24 the system is a function of the energy required by customers. In order to allocate this

1 expense among classes, we must determine how much each class contributes to the
2 total kWh consumption and we must recognize the line losses associated with
3 transporting and distributing the kWh. These contributions, expressed in percentage
4 terms, are then multiplied by the expense to determine how much expense should be
5 attributed to each class. For demand-related costs, we construct an allocation factor
6 by looking at the important class demands.

7 **Utility System Characteristics**

8 **Q WHAT IS THE IMPORTANCE OF UTILITY SYSTEM LOAD CHARACTERISTICS?**

9 A Utility system load characteristics are an important factor in determining the specific
10 method which should be employed to allocate fixed, or demand-related costs on a
11 utility system. The most important characteristic is the annual load pattern of the
12 utility. These characteristics for MPS are shown on Schedule MEB-COS-1. For
13 convenience, it is also shown here as Figure 4.

Figure 4

KCP&L GREATER MISSOURI OPERATIONS COMPANY

**Analysis of KCP&L Greater Missouri Operations Company
For All Territories Served as MPS
Monthly Peak Demands
as a Percent of the Annual System Peak
For the Test Year Ended September 2009**

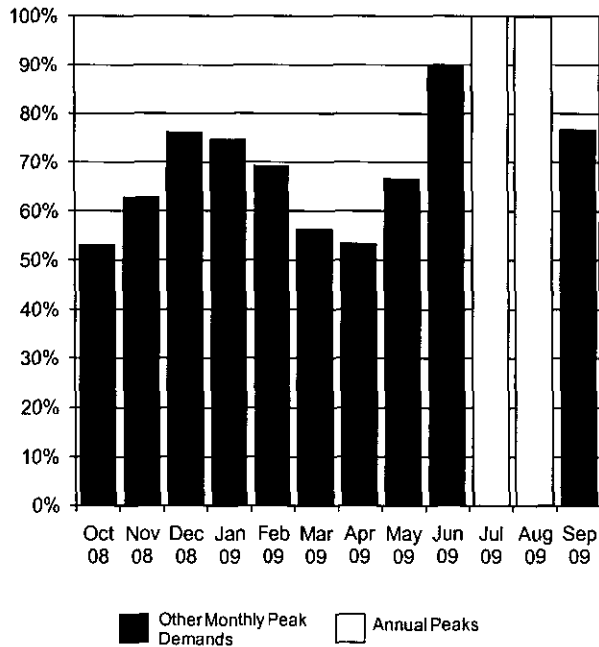

1
2
3
4
5
6
7
8
9

This shows the monthly system peak demands for the test year used in the study. The highlighted bars show the months in which the highest peak occurred.

This analysis shows that summer peaks dominate the GMO system. (This same information is presented in tabular form on Schedule MEB-COS-2.) This clearly shows that nearly identical system peaks occurred in July and August. These peaks are substantially higher than the monthly peaks occurring in most other months. The peaks in June and September were 10% and 23%, respectively, lower than the annual peak.

1 **Q** **WHAT CRITERIA SHOULD BE USED TO DETERMINE AN APPROPRIATE**
2 **METHOD FOR ALLOCATING PRODUCTION AND TRANSMISSION CAPACITY**
3 **COSTS AMONG THE VARIOUS CUSTOMER CLASSES?**

4 **A** The specific allocation method should be consistent with the principle of
5 cost-causation; that is, the allocation should reflect the contribution of each customer
6 class to the demands that caused the utility to incur capacity costs.

7 **Q** **WHAT FACTORS CAUSE ELECTRIC UTILITIES TO INCUR PRODUCTION AND**
8 **TRANSMISSION CAPACITY COSTS?**

9 **A** As discussed previously, production and transmission plant must be sized to meet the
10 maximum demand imposed on these facilities. Thus, an appropriate allocation
11 method should accurately reflect the characteristics of the loads served by the utility.
12 For example, if a utility has a high summer peak relative to the demands in other
13 seasons, then production and transmission capacity costs should be allocated
14 relative to each customer class's contribution to the summer peak demands. If a
15 utility has predominant peaks in both the summer and winter periods, then an
16 appropriate allocation method would be based on the demands imposed during both
17 the summer and winter peak periods. For a utility with a very high load factor and/or
18 a non-seasonal load pattern, then demands in all months may be important.

19 **Q** **WHAT DO THESE CONSIDERATIONS MEAN IN THE CONTEXT OF THE GMO**
20 **SYSTEM?**

21 **A** As noted, the MPS load pattern has predominant summer peaks. This means that
22 these demands should be the primary ones used in the allocation of generation and
23 transmission costs. Demands in other months are of much less significance, do not

1 compel the addition of generation capacity to serve them and should not be used in
2 determining the allocation of costs.

3 **Q WHAT SPECIFIC RECOMMENDATIONS DO YOU HAVE?**

4 A The two most predominantly used allocation methods in the industry are the
5 coincident peak method and the A&E demand method.

6 The coincident method utilizes the demands of customer classes occurring at
7 the time of the system peak or peaks selected for allocation. In the case of MPS, this
8 would be one or more peaks occurring during the summer.

9 **Q WHAT IS THE A&E METHOD?**

10 A The A&E method is one of a family of methods which incorporates a consideration of
11 both the maximum rate of use (demand) and the duration of use (energy). As the
12 name implies, A&E makes a conceptual split of the system into an "average"
13 component and an "excess" component. The "average" demand is simply the total
14 kWh usage divided by the total number of hours in the year. This is the amount of
15 capacity that would be required to produce the energy if it were taken at the same
16 demand rate each hour. The system "excess" demand is the difference between the
17 system peak demand and the system average demand.

18 Under the A&E method, the average demand is allocated to classes in
19 proportion to their average demand (energy usage). The difference between the
20 system average demand and the system peak(s) is then allocated to customer
21 classes on the basis of a measure that represents their "peaking" or variability in
22 usage.¹

¹NARUC Electric Utility Cost Allocation Manual, 1992, page 81.

1 Q WHAT DO YOU MEAN BY VARIABILITY IN USAGE?

2 A As an example, Figure 5 shows two classes that have different monthly usage
3 patterns.

Figure 5
Load Patterns

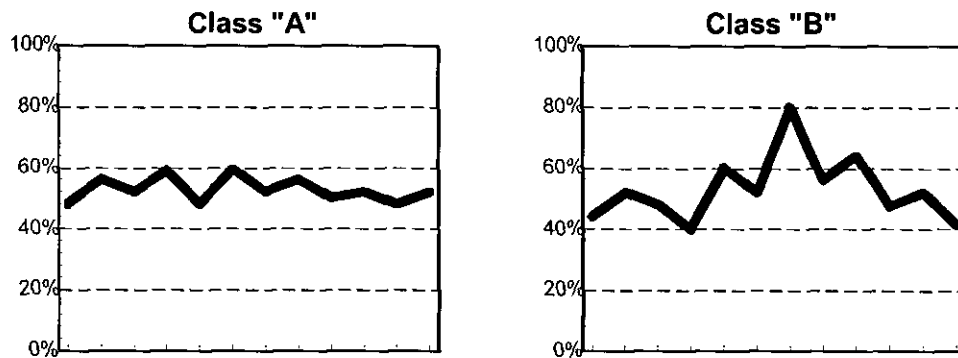

4 Both classes use the same total amount of energy and, therefore, have the same
5 average demand. Class B, though, has a much greater maximum demand² than
6 Class A. The greater maximum demand imposes greater costs on the utility system.
7 This is because the utility must provide sufficient capacity to meet the projected
8 maximum demands of its customers. There may also be higher costs due to the
9 greater variability of usage of some classes. This variability requires that a utility
10 cycle its generating units in order to match output with demand on a real time basis.
11 The stress of cycling generating units up and down causes wear and tear on the
12 equipment, resulting in higher maintenance cost.

13 Thus, the excess component of the A&E method is an attempt to allocate the
14 additional capacity requirements of the system (measured by the system excess) in

²During any specified time period (e.g., month, year), the maximum demand of a class, regardless of when it occurs, is called the non-coincident peak demand.

1 proportion to the "peakiness" of the customer classes (measured by the class excess
2 demands).

3 **Q WHAT DEMAND ALLOCATION METHODOLOGY DO YOU RECOMMEND FOR**
4 **GENERATION AND TRANSMISSION?**

5 **A** First, in order to reflect cost-causation the methodology must give predominant weight
6 to loads occurring during the summer months. Loads during these months (the peak
7 loads) are the primary driver which has and continues to cause the utility to expand
8 its generation and transmission capacity, and therefore should be given predominant
9 weight in the allocation of capacity costs.

10 Either a coincident peak study, using the demands during the summer (peak)
11 months, or a version of an A&E cost of service study that uses class non-coincident
12 peak loads occurring during the summer, would be most appropriate to reflect these
13 characteristics. The results should be similar as long as only summer period peak
14 loads are used. I will make my recommendations based on the A&E method. It
15 considers the maximum class demands during the critical time periods, and is less
16 susceptible to variations in the absolute hour in which peaks occur – producing a
17 somewhat more stable result over time.

18 Based on test year load characteristics, I believe the most appropriate A&E
19 allocation would be using July and August system peaks. However, the allocation
20 factors for all classes under that approach are very close to the A&E-4NCP allocation
21 factors.

22 Schedule MEB-COS-3 shows the derivation of the A&E demand allocation
23 factor for generation using the four annual class non-coincident peaks.

1 **Q REFERRING TO SCHEDULE MEB-COS-3, PLEASE EXPLAIN THE**
2 **DEVELOPMENT OF THE A&E ALLOCATION FACTOR.**

3 A Line 2 shows the average of the four non-coincident peaks for each class. Line 3
4 shows the annual amount of energy required by each class. Line 4 is the average
5 demand, in kilowatts, which is determined by dividing the annual energy in line 3 by
6 the number of hours (8,760) in a year. Line 5 shows the percentage relationship
7 between the average demand for each class and the total system.

8 The excess demand, shown on line 6, is equal to the non-coincident peak
9 demand shown on line 2 minus the average demand that is shown on line 4. Line 7
10 shows the excess demand percentage, which is a relationship among the excess
11 demand of each customer class and the total excess demand for all classes.

12 Finally, line 10 presents the composite A&E allocation factor. It is determined
13 by weighting the average demand responsibility of each class (which is the same as
14 each class's energy allocation factor) by the system load factor, and weighting the
15 excess demand factor by the quantity one minus the system load factor.

16 **Q IT IS NOTED THAT WHILE MPS HAS A PREDOMINATE SUMMER PEAK, L&P**
17 **HAS PREDOMINATE PEAKS IN BOTH SUMMER AND WINTER. IS THE SAME**
18 **ALLOCATION METHOD APPROPRIATE FOR BOTH?**

19 A Yes. The A&E-4NCP methodology is appropriate for both. In the case of MPS, data
20 from the four peak months occurring in the summer is used. In the case of L&P, data
21 from the two highest summer peaks and the two highest winter peaks is used.

1 **Making the Cost of Service Study – Summary**

2 **Q PLEASE SUMMARIZE THE PROCESS AND THE RESULTS OF A COST OF**
3 **SERVICE ANALYSIS.**

4 **A** As previously discussed, the cost of service procedure involves three steps:

- 5 1. Functionalization – Identify the different functional "levels" of the system;
- 6 2. Classification – Determine, for each functional type, the primary cause or causes
7 (customer, demand or energy) of that cost being incurred; and
- 8 3. Allocation – Calculate the class proportional responsibilities for each type of cost
9 and spread the cost among classes.

10 **Q WHERE ARE YOUR COST OF SERVICE RESULTS PRESENTED?**

11 **A** The results are presented in Schedule MEB-COS-4, which reflects results at present
12 rates.

13 **Q REFERRING TO SCHEDULE MEB-COS-4, PLEASE EXPLAIN THE**
14 **ORGANIZATION AND WHAT IS SHOWN.**

15 **A** Schedule MEB-COS-4 is a summary of the key elements and the results of the class
16 cost of service study. The top section of the schedule shows the revenues, expenses
17 and operating income based on an A&E-4NCP cost of service study.

18 The next section shows the major elements of rate base, and the rate of return
19 at present rates for each customer class based on this cost of service study.

20 **Q DID GMO SUBMIT CLASS COST OF SERVICE STUDIES?**

21 **A** Yes. GMO submitted a class cost of service study for each territory. These studies
22 base the allocation of generation costs on an obscure and inappropriate allocation
23 method. GMO's method is not grounded in appropriate cost causation principles, and

1 should not be accepted. I will address this proposed methodology in more detail in
2 my rebuttal testimony.

3 **Q HAVE YOU USED ITS STUDY?**

4 A I have used the study framework as a basis for preparing my cost of service study.
5 As explained below, I have developed a cost of service study using a different
6 allocation for generation fixed costs, and also a different allocation of the margin on
7 off-system sales.

8 **Q HAVE YOU PREPARED ANY COST OF SERVICE STUDIES BESIDES THE**
9 **A&E-4NCP STUDY PRESENTED IN SCHEDULE MEB-COS-4?**

10 A Yes. I have prepared studies based on A&E-2NCP, and also 4CP methodologies.
11 The derivation of the generation capacity allocation factor and the results of each cost
12 of service study are presented in the Appendix to my schedules.

13 **Q OTHER THAN THE USE OF A DIFFERENT ALLOCATION FOR GENERATION**
14 **FIXED COSTS, HOW DO YOUR STUDIES DIFFER FROM THE ONES**
15 **PRESENTED BY GMO?**

16 A There also is a difference in the allocation of the revenue from off-system sales.

17 **Q WHAT IS THE ISSUE WITH RESPECT TO THE ALLOCATION OF OFF-SYSTEM**
18 **SALES?**

19 A GMO has allocated the revenues from off-system sales on the basis of measures of
20 class demands.

1 The more traditional approach is to allocate the revenues from off-system
2 sales to customer classes on the basis of class kWh requirements. This would make
3 the allocation of the revenues consistent with the allocation of the underlying costs.
4 (This method was recently adopted in a KCPL rate case, Case No. ER-2006-0314,
5 and re-affirmed in Ameren Missouri's most recently concluded rate case, Case
6 No. ER-2010-0036.)

7 **Q HOW DID YOU USE GMO'S COST OF SERVICE MODEL IN PRODUCING YOUR**
8 **CLASS COST OF SERVICE STUDY?**

9 A It was the starting point. The results of GMO's allocation first were replicated by
10 utilizing the data contained in its cost of service model. Many of GMO's allocation
11 factors and functionalizations and classifications have been utilized. The principal
12 areas where I depart from GMO and use a different approach were incorporated into
13 the allocations. They have previously been explained in this testimony.

14 **Adjustment of Class Revenues**

15 **Q WHAT SHOULD BE THE PRIMARY BASIS FOR ESTABLISHING CLASS**
16 **REVENUE REQUIREMENTS AND DESIGNING RATES?**

17 A Cost should be the primary factor used in both steps.

18 Just as cost of service is used to establish a utility's total revenue requirement,
19 it should also be the primary basis used to establish the revenues collected from each
20 customer class and to design rate schedules.

21 Factors such as simplicity, gradualism and ease of administration may also be
22 taken into account, but the basic starting point and guideline throughout the process
23 should be cost of service. To the extent practicable, rate schedules should be

1 structured and designed to reflect the important cost-causative features of the service
2 provided, and to collect the appropriate cost from the customers within each class or
3 rate schedule, based upon the individual load patterns exhibited by those customers.

4 Electric rates also play a role in economic development, both with respect to
5 job creation and job retention. This is particularly true in the case of industries where
6 electricity is a large component of the cost of production.

7 **Q WHAT IS THE BASIS FOR YOUR RECOMMENDATION THAT COST BE USED AS**
8 **THE PRIMARY FACTOR FOR THESE PURPOSES?**

9 A The basic reasons for using cost as the primary factor are equity, conservation, and
10 engineering efficiency (cost-minimization).

11 **Q PLEASE EXPLAIN HOW EQUITY IS ACHIEVED BY BASING RATES ON COST.**

12 A When rates are based on cost, each customer pays what it costs the utility to provide
13 service to that customer; no more and no less. If rates are based on anything other
14 than cost factors, then some customers will pay the costs attributable to providing
15 service to other customers – which is inherently inequitable.

16 **Q HOW DO COST-BASED RATES FURTHER THE GOAL OF CONSERVATION?**

17 A Conservation occurs when wasteful, inefficient use is discouraged or minimized. Only
18 when rates are based on costs do customers receive a balanced price signal upon
19 which to make their electric consumption decisions. If rates are not based on costs,
20 then customers who are not paying their full costs may be misled into using
21 electricity inefficiently in response to the distorted rate design signals they receive.

1 **Q WILL COST-BASED RATES ASSIST IN THE DEVELOPMENT OF**
2 **COST-EFFECTIVE DEMAND-SIDE MANAGEMENT ("DSM") PROGRAMS?**

3 A Yes. The success of DSM (both energy efficiency and demand response programs)
4 depends, to a large extent, on customer receptivity. There are many actions that can
5 be taken by consumers to reduce their electricity requirements. A major element in a
6 customer's decision-making process is the amount of reduction that can be achieved
7 in the electric bill as a result of DSM activities. If the bill received by a customer is
8 subsidized by other customers; that is, the bill is determined using rates which are
9 below cost, that customer will have less reason to engage in DSM activities than
10 when the bill reflects the actual cost of the electric service provided.

11 For example, assume that the relevant cost to produce and deliver energy is
12 8¢ per kWh. If a customer has an opportunity to install energy efficiency or DSM
13 equipment that would allow the customer to reduce energy use or demand, the
14 customer will be much more likely to make that investment if the price of electricity
15 equals the cost of electricity, i.e., 8¢ per kWh, than if the customer is receiving a
16 subsidized rate of 6¢ per kWh.

17 **Q HOW DO COST-BASED RATES ACHIEVE THE COST-MINIMIZATION**
18 **OBJECTIVE?**

19 A When the rates are designed so that the energy costs, demand costs and customer
20 costs are properly reflected in the energy, demand and customer components of the
21 rate schedules, respectively, customers are provided with the proper incentives to
22 minimize their costs, which will in turn minimize the costs to the utility.

23 If a utility attempts to extract a disproportionate share of revenues from a class
24 that has alternatives available (such as producing products at other locations where

1 costs are lower), then the utility will be faced with the situation where it must discount
2 the rates or lose the load, either in part or in total. To the extent that the load could
3 have been served more economically by the utility, then either the other customers of
4 the utility or the stockholders (or some combination of both) will be worse off than if
5 the rates were properly designed on the basis of cost.

6 From a rate design perspective, overpricing the energy portion of the rate and
7 underpricing the fixed components of the rate (such as customer and demand
8 charges) will result in a disproportionate share of revenues being collected from large
9 customers and high load factor customers. To the extent that these customers may
10 have lower cost alternatives than do the smaller or the low load factor customers, the
11 same problems noted above are created.

12 Revenue Allocation

13 **Q PLEASE REFER AGAIN TO SCHEDULE MEB-COS-4 FOR MPS AND**
14 **SUMMARIZE THE RESULTS OF YOUR CLASS COST OF SERVICE STUDY.**

15 **A** As indicated on the last two lines on Schedule MEB-COS-4, movement of all classes
16 to cost of service will require a large increase to the Lighting class, a large decrease
17 to the Small General Service ("SGS") class and a system average increase to the
18 Residential, Large General Service ("LGS") and Large Power Service ("LPS") service
19 classes.

20 **Q WHAT ADJUSTMENTS TO REVENUES WOULD BE REQUIRED AT PRESENT**
21 **RATES TO MOVE ALL CLASSES TO COST OF SERVICE?**

22 **A** This is shown on Schedule MEB-COS-5 for MPS. The first five columns summarize
23 the results of the cost of service study at present rates, and are taken from

1 Schedule MEB-COS-4. The remaining columns of Schedule MEB-COS-5 determine
2 the amount of increase or decrease, on a revenue neutral basis, required to move
3 each customer class to the average rate of return at current revenue levels. That is, it
4 shows the amount of increase or decrease required to have every class yield the
5 same rate of return, before considering any overall increase in revenues. Note that
6 the Lighting class would require an increase of about \$1.2 million, or 13.4%, in order
7 to move to cost of service. All other classes would require a corresponding decrease.
8 The SGS class would need a \$5.8 million, or 7.3%, decrease, and all other classes
9 essentially zero movement.

10 **Q PLEASE REFER TO SCHEDULE MEB-COS-4 AND MEB-COS-5 FOR L&P AND**
11 **EXPLAIN THE RESULTS.**

12 A For L&P, the Residential class and the Lighting class are significantly below cost of
13 service. The GS, LGS and LPS classes are above cost of service. Moving to cost of
14 service would require a 5.9% increase for residential customers, and an 11%
15 increase for lighting customers.

16 **Q HOW DOES GMO PROPOSE TO ADJUST REVENUES?**

17 A GMO proposes essentially an equal per centage across-the-board increase.

18 **Q WOULD GMO'S ALLOCATION MOVE CLASS RATES CLOSER TO COST OF**
19 **SERVICE?**

20 A No. GMO's allocation would essentially maintain the status quo in which the Lighting
21 class is substantially below cost of service, and the SGS class is above cost of
22 service.

1 **Q DO YOU HAVE AN ALTERNATIVE RECOMMENDATION FOR ALLOCATION OF**
2 **MPS'S REVENUE REQUIREMENT?**

3 A Yes. I will focus on adjustments to be made on a revenue neutral basis at present
4 rates. After having made my recommended revenue neutral adjustments at present
5 rates, any overall change in revenues allowed to GMO can then be applied on an
6 equal percentage across-the-board basis to these adjusted class revenues.

7 **Q PLEASE EXPLAIN YOUR SPECIFIC PROPOSAL.**

8 A My specific proposal is shown on Schedule MEB-COS-6 for MPS. Column 1 shows
9 class revenues at current rates. Column 2 shows my proposed cost of service
10 adjustment. This adjustment moves classes roughly 25% of the way toward cost of
11 service. This 25% movement was selected because it makes a reasonable step in
12 the right direction without imposing too disruptive of a revenue increase on the
13 Lighting class. An overall revenue-neutral increase of about 3.4% on the Lighting
14 class is a relatively modest step, but at least it is a step in the right direction.

15

16 **Q WHAT IS YOUR SPECIFIC PROPOSAL FOR L&P?**

17 A My specific proposal is shown on Schedule MEB-COS-6 for L&P. Column 1 shows
18 class revenues at current rates. Column 2 shows my proposed cost of service
19 adjustments. This adjustment moves classes roughly 25% of the way toward cost of
20 service. This 25% movement was selected because it makes a reasonable step in
21 the right direction without imposing too disruptive of a revenue increase on the
22 Residential and Lighting classes.

1 My recommendation of moving 25% of the way toward cost of service limits
2 the L&P Lighting class revenue-neutral increase to 2.8% (as compared to the 11%
3 increase required to move all the way to cost of service).

4 **Q DOES THIS CONCLUDE YOUR DIRECT TESTIMONY?**

5 **A Yes, it does.**

Qualifications of Maurice Brubaker

1 **Q PLEASE STATE YOUR NAME AND BUSINESS ADDRESS.**

2 A Maurice Brubaker. My business address is 16690 Swingley Ridge Road, Suite 140,
3 Chesterfield, MO 63017.

4 **Q PLEASE STATE YOUR OCCUPATION.**

5 A I am a consultant in the field of public utility regulation and President of the firm of
6 Brubaker & Associates, Inc. (BAI), energy, economic and regulatory consultants.

7 **Q PLEASE SUMMARIZE YOUR EDUCATIONAL BACKGROUND AND**
8 **EXPERIENCE.**

9 A I was graduated from the University of Missouri in 1965, with a Bachelor's Degree in
10 Electrical Engineering. Subsequent to graduation I was employed by the Utilities
11 Section of the Engineering and Technology Division of Esso Research and
12 Engineering Corporation of Morristown, New Jersey, a subsidiary of Standard Oil of
13 New Jersey.

14 In the Fall of 1965, I enrolled in the Graduate School of Business at
15 Washington University in St. Louis, Missouri. I was graduated in June of 1967 with
16 the Degree of Master of Business Administration. My major field was finance.

17 From March of 1966 until March of 1970, I was employed by Emerson Electric
18 Company in St. Louis. During this time I pursued the Degree of Master of Science in
19 Engineering at Washington University, which I received in June, 1970.

20 In March of 1970, I joined the firm of Drazen Associates, Inc., of St. Louis,
21 Missouri. Since that time I have been engaged in the preparation of numerous

1 studies relating to electric, gas, and water utilities. These studies have included
2 analyses of the cost to serve various types of customers, the design of rates for utility
3 services, cost forecasts, cogeneration rates and determinations of rate base and
4 operating income. I have also addressed utility resource planning principles and
5 plans, reviewed capacity additions to determine whether or not they were used and
6 useful, addressed demand-side management issues independently and as part of
7 least cost planning, and have reviewed utility determinations of the need for capacity
8 additions and/or purchased power to determine the consistency of such plans with
9 least cost planning principles. I have also testified about the prudence of the actions
10 undertaken by utilities to meet the needs of their customers in the wholesale power
11 markets and have recommended disallowances of costs where such actions were
12 deemed imprudent.

13 I have testified before the Federal Energy Regulatory Commission (FERC),
14 various courts and legislatures, and the state regulatory commissions of Alabama,
15 Arizona, Arkansas, California, Colorado, Connecticut, Delaware, Florida, Georgia,
16 Guam, Hawaii, Illinois, Indiana, Iowa, Kentucky, Louisiana, Michigan, Missouri,
17 Nevada, New Jersey, New Mexico, New York, North Carolina, Ohio, Pennsylvania,
18 Rhode Island, South Carolina, South Dakota, Texas, Utah, Virginia, West Virginia,
19 Wisconsin and Wyoming.

20 The firm of Drazen-Brubaker & Associates, Inc. was incorporated in 1972 and
21 assumed the utility rate and economic consulting activities of Drazen Associates, Inc.,
22 founded in 1937. In April, 1995 the firm of Brubaker & Associates, Inc. was formed. It
23 includes most of the former DBA principals and staff. Our staff includes consultants
24 with backgrounds in accounting, engineering, economics, mathematics, computer
25 science and business.

1 Brubaker & Associates, Inc. and its predecessor firm has participated in over
2 700 major utility rate and other cases and statewide generic investigations before
3 utility regulatory commissions in 40 states, involving electric, gas, water, and steam
4 rates and other issues. Cases in which the firm has been involved have included
5 more than 80 of the 100 largest electric utilities and over 30 gas distribution
6 companies and pipelines.

7 An increasing portion of the firm's activities is concentrated in the areas of
8 competitive procurement. While the firm has always assisted its clients in negotiating
9 contracts for utility services in the regulated environment, increasingly there are
10 opportunities for certain customers to acquire power on a competitive basis from a
11 supplier other than its traditional electric utility. The firm assists clients in identifying
12 and evaluating purchased power options, conducts RFPs and negotiates with
13 suppliers for the acquisition and delivery of supplies. We have prepared option
14 studies and/or conducted RFPs for competitive acquisition of power supply for
15 industrial and other end-use customers throughout the United States and in Canada,
16 involving total needs in excess of 3,000 megawatts. The firm is also an associate
17 member of the Electric Reliability Council of Texas and a licensed electricity
18 aggregator in the State of Texas.

19 In addition to our main office in St. Louis, the firm has branch offices in
20 Phoenix, Arizona and Corpus Christi, Texas.

\\Doc\Shares\ProlawDocs\TSK\9216\1\Testimony - BA\187115.doc

KCP&L GREATER MISSOURI OPERATIONS COMPANY

Analysis of KCP&L Greater Missouri Operations Company For All Territories Served as MPS Monthly Peak Demands as a Percent of the Annual System Peak For the Test Year Ended September 2009

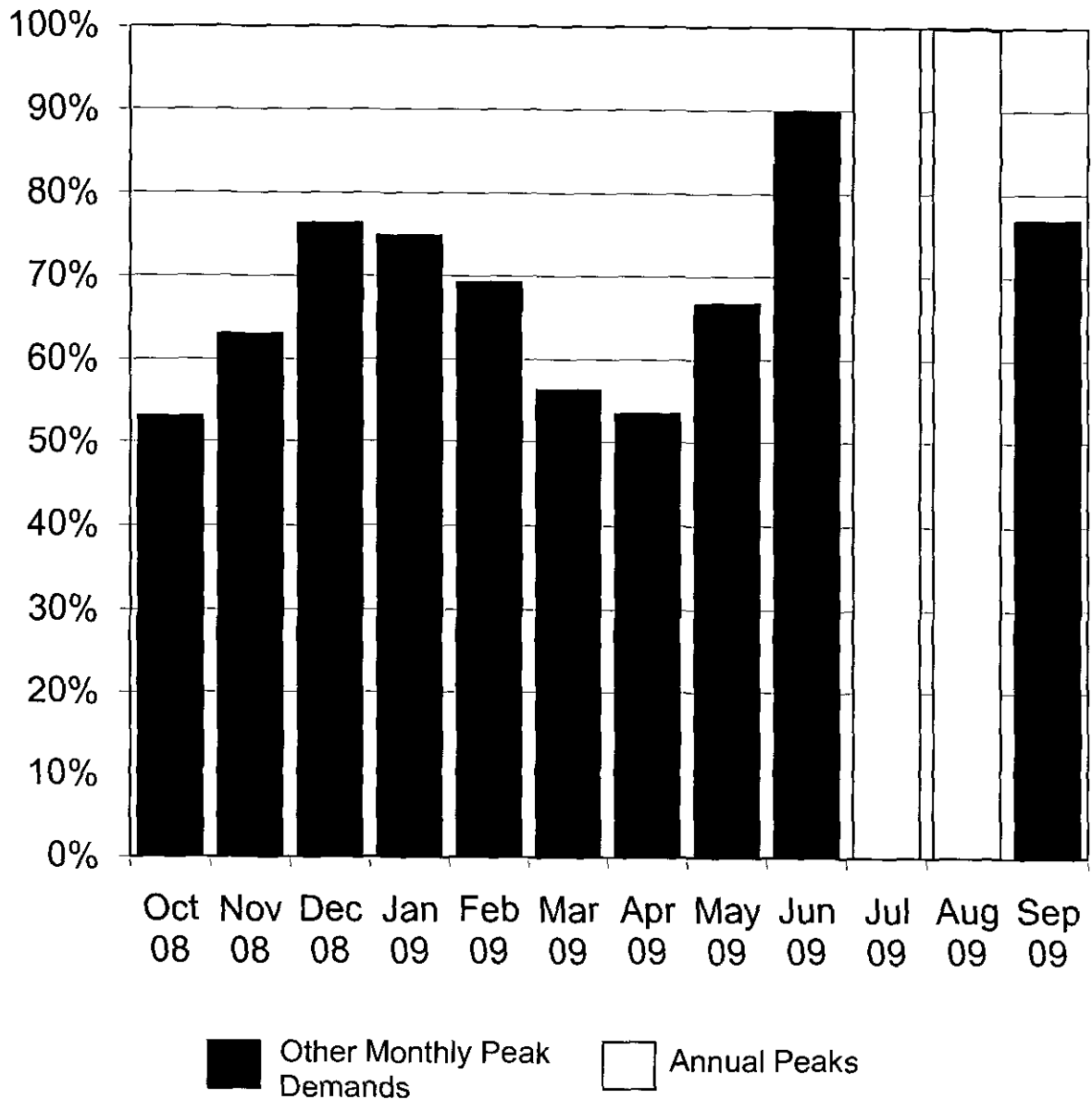

KCP&L GREATER MISSOURI OPERATIONS COMPANY

**Analysis of KCP&L Greater Missouri Operations Company
For All Territories Served as MPS
Monthly Peak Demands
as a Percent of the Annual System Peak
(Weather Normalized and with Losses)
For the Test Year Ended September 2009**

<u>Line</u>	<u>Description</u>	<u>MPS Retail MW (1)</u>	<u>Percent (2)</u>
1	January	1,151	75.0
2	February	1,064	69.4
3	March	867	56.5
4	April	823	53.7
5	May	1,026	66.9
6	June	1,380	90.0
7	July	1,534	100.0
8	August	1,532	99.9
9	September	1,181	77.0
10	October	817	53.3
11	November	968	63.1
12	December	1,173	76.5

Source: Schedule GMM2010-3

**KCP&L GREATER MISSOURI OPERATIONS COMPANY
FOR ALL TERRITORIES SERVED AS MPS**

**Development of
Average and Excess Demand Allocator
Based on 4 Non-Coincident Peaks
For the Test Year Ended December 2009**

<u>Line</u>	<u>Description</u>	<u>MPS Retail (1)</u>	<u>Residential (2)</u>	<u>Small General Service (3)</u>	<u>Large General Service (4)</u>	<u>Large Power Service (5)</u>	<u>Lighting (6)</u>
1	Territory System Peak - kW	1,534,456					
2	Avg of 4 Highest Monthly NCP Values - kW	1,501,634	851,994	209,901	193,152	235,052	11,535
3	Energy Sales with Losses - MWh	6,328,298	2,979,524	868,269	963,973	1,466,383	50,149
4	Average Demand - kW	722,408	340,128	99,117	110,043	167,395	5,725
5	Average Demand - Percent	1.000000	0.470825	0.137204	0.152327	0.231718	0.007925
6	Class Excess Demand - kW	779,226	511,866	110,783	83,110	67,657	5,810
7	Class Excess Demand - Percent	1.000000	0.656890	0.142171	0.106657	0.086826	0.007456
	Allocator:						
8	Annual Load Factor * Average Demand	0.470791	0.221661	0.064595	0.071714	0.109091	0.003731
9	(1-LF) * Excess Demand	<u>0.529209</u>	<u>0.347632</u>	<u>0.075238</u>	<u>0.056444</u>	<u>0.045949</u>	<u>0.003946</u>
10	Average and Excess Demand Allocator	1.000000	0.569292	0.139833	0.128158	0.155040	0.007677

Notes:
Line 4 equals Line 3 ÷ 8.760
Line 6 equals Line 2- Line 4

System Annual Load Factor 47.08%
1 - Load Factor 52.92%

Source: KCPL Allocators MPS 05-21-10.xls

KCP&L GREATER MISSOURI OPERATIONS COMPANY
 FOR ALL TERRITORIES SERVED AS MPS
 CLASS COST OF SERVICE
 TEST YEAR 12-2009 WITH KNOWN & MEASURABLE CHANGES TO 12-31-2010

LINE NO.	DESCRIPTION	MPS RETAIL (1)	RESIDENTIAL (2)	SMALL GEN. SERVICE (3)	LARGE GEN. SERVICE (4)	LARGE PWR SERVICE (5)	LIGHTING (6)
0010	SCHEDULE 1 - SUMMARY OF OPERATING INC & RATE BASE						
0020							
0030	OPERATING REVENUE						
0040	RETAIL SALES REVENUE	525,150,206	286,123,315	77,927,755	66,598,381	85,731,870	8,768,886
0050	OTHER OPERATING REVENUE	15,351,219	8,045,838	2,023,067	2,140,265	2,980,961	161,088
0060	TOTAL OPERATING REVENUE	540,501,425	294,169,153	79,950,821	68,738,646	88,712,830	8,929,974
0070							
0080	OPERATING EXPENSES						
0090	FUEL	123,074,108	58,037,565	16,859,187	18,717,319	28,492,154	967,883
0100	PURCHASED POWER	74,560,985	35,736,974	10,128,535	11,226,479	16,904,438	564,559
0110	OTHER OPERATION & MAINTENANCE EXPENSES	153,068,760	93,521,635	21,861,565	16,372,935	17,793,174	3,519,452
0120	DEPRECIATION EXPENSES (AFTER CLEARINGS)	67,044,343	39,376,261	9,043,874	7,897,203	8,598,304	2,128,700
0130	AMORTIZATION EXPENSES	1,519,787	890,044	203,639	183,763	207,319	35,022
0140	TAXES OTHER THAN INCOME TAXES	17,199,036	10,167,638	2,352,695	2,017,048	2,232,705	428,950
0150	FEDERAL AND STATE INCOME TAXES	18,587,511	9,212,264	4,656,602	2,063,489	2,413,214	241,942
0160	TOTAL ELECTRIC OPERATING EXPENSES	455,054,530	246,942,380	65,106,097	58,478,237	76,641,308	7,886,509
0170							
0180	NET ELECTRIC OPERATING INCOME	85,446,895	47,226,773	14,844,724	10,260,409	12,071,523	1,043,465
0190							
0200	RATE BASE						
0210	TOTAL ELECTRIC PLANT	2,351,919,419	1,382,834,898	317,475,986	281,285,092	312,432,486	57,890,956
0220	LESS: ACCUM. PROV. FOR DEPREC	767,525,911	456,823,261	103,084,070	89,341,438	94,788,130	23,489,012
0230	NET PLANT	1,584,393,508	926,011,638	214,391,917	191,943,654	217,644,356	34,401,943
0240	PLUS:						
0250	CASH WORKING CAPITAL	(1,152,930)	(1,355,395)	(136,753)	27,754	439,815	(128,350)
0260	MATERIALS & SUPPLIES	27,552,314	16,199,663	3,719,174	3,295,204	3,660,091	678,182
0270	SO2 EMISSION ALLOWANCES	3,304,532	1,881,245	462,081	423,503	512,335	25,368
0280	PREPAYMENTS	1,889,742	1,111,093	255,089	226,010	251,036	46,515
0290	FUEL INVENTORY	34,305,171	16,177,152	4,699,260	5,217,189	7,941,786	269,784
0300	AAO DEF DIBLEY REB & WESTERN COAL 1990	25,852	14,717	3,615	3,313	4,008	198
0310	AAO DEF DIBLEY REB & WESTERN COAL 1992	364,421	207,462	50,958	46,704	58,500	2,798
0320	DEFERRAL OF DSM/EE COSTS	12,726,278	7,330,308	1,530,968	1,660,598	2,159,279	45,126
0330	ERPP	217,092	125,045	26,116	28,327	36,834	770
0340	IATAN 1 REGULATORY ASSET	2,598,317	1,479,202	363,330	332,996	402,843	19,946
0350	REGULATORY ASSET-ERISA MINIMUM TRACKER	8,554,384	5,272,943	1,204,956	902,358	930,749	243,377
0360	LESS:						
0370	CUSTOMER ADVANCES FOR CONSTRUCTION	5,893,381	3,637,881	791,362	612,455	518,635	333,047
0380	CUSTOMER DEPOSITS	5,740,655	287,569	5,215,969	216,383	20,324	411
0390	TOTAL ACCUMULATED DEFERRED TAXES	194,258,902	114,216,493	26,222,215	23,232,995	25,805,643	4,781,556
0400	TOTAL ACCUMULATED DEFERRED TAXES - AAO	149,826	88,092	20,224	17,919	19,903	3,688
0410	TOTAL RATE BASE	1,468,735,918	856,225,038	194,320,940	180,027,856	207,675,128	30,486,957
0420							
0430	RATE OF RETURN	5.818%	5.516%	7.639%	5.699%	5.813%	3.423%
0440	RELATIVE RATE OF RETURN	1.00	0.95	1.31	0.98	1.00	0.59

Note:

Production Plant and Expense Allocated using A&E-4NCP.
 SFR Off System Sales and SFR Off System Sales - L&P Revenue Allocated on Energy.

**KCP&L GREATER MISSOURI OPERATIONS COMPANY
FOR ALL TERRITORIES SERVED AS MPS**

**Class Cost of Service Study Results
and Revenue Adjustments to Move Each Class to Cost of Service
Using Modified ECOS at Present Rates
(\$ in Thousands)**

<u>Line</u>	<u>Rate Class</u>	<u>Current Revenues</u> (1)	<u>Current Rate Base</u> (2)	<u>Net Operating Income</u> (3)	<u>Earned ROR</u> (4)	<u>Indexed ROR</u> (5)	<u>Income @ Average Current ROR*</u> (6)	<u>Difference in Income</u> (7)	<u>Revenue Increase</u> (8)	<u>Percentage Increase</u> (9)
1	Residential	\$ 294,169	\$ 856,225	\$ 47,227	5.516%	95	\$ 49,813	\$ 2,586	\$ 4,244	1.4%
2	Small General Service	79,951	194,321	14,845	7.639%	131	11,305	(3,540)	(5,809)	-7.3%
3	Large General Service	68,739	180,028	10,260	5.699%	98	10,474	213	350	0.5%
4	Large Power Service	88,713	207,675	12,072	5.813%	100	12,082	10	17	0.0%
5	Total Lighting	<u>8,930</u>	<u>30,487</u>	<u>1,043</u>	3.423%	59	<u>1,774</u>	<u>730</u>	<u>1,198</u>	13.4%
6	Total	\$ 540,501	\$ 1,468,736	\$ 85,447	5.818%	100	\$ 85,447	\$ (0)	\$ (0)	0.0%

Source: Schedule MEB-COS-4

* Column 2 x Column 4, Line 6 (5.818%)

**KCP&L GREATER MISSOURI OPERATIONS COMPANY
FOR ALL TERRITORIES SERVED AS MPS**

**Recommended Cost of Service Adjustments
Using Modified ECOS at Present Rates
(\$ in Millions)**

<u>Line</u>	<u>Rate Class</u>	<u>Current Revenues (1)</u>	<u>Move 25% Toward Cost Of Service (2)</u>	<u>Adjusted Current Revenue (3)</u>	<u>Percent of Adjusted Current Revenue (4)</u>
1	Residential	\$ 294.2	\$ 1.1	\$ 295.2	54.62%
2	Small General Service	80.0	(1.5)	78.5	14.52%
3	Large General Service	68.7	0.1	68.8	12.73%
4	Large Power Service	88.7	0.0	88.7	16.41%
5	Total Lighting	<u>8.9</u>	<u>0.3</u>	<u>9.2</u>	1.71%
6	Subtotal	\$ 540.5	\$ -	\$ 540.5	100.00%

**KCP&L GREATER MISSOURI OPERATIONS COMPANY
FOR ALL TERRITORIES SERVED AS MPS**

**Development of
Average and Excess Demand Allocator
Based on 2 Non-Coincident Peaks
For the Test Year Ended December 2009**

<u>Line</u>	<u>Description</u>	<u>MPS Retail (1)</u>	<u>Residential (2)</u>	<u>Small General Service (3)</u>	<u>Large General Service (4)</u>	<u>Large Power Service (5)</u>	<u>Lighting (6)</u>
1	Territory System Peak - kW	1,534,456					
2	Avg of 2 Highest Monthly NCP Values - kW	1,623,427	956,538	221,942	192,880	240,533	11,535
3	Energy Sales with Losses - MWh	6,328,298	2,979,524	868,269	963,973	1,466,383	50,149
4	Average Demand - kW	722,408	340,128	99,117	110,043	167,395	5,725
5	Average Demand - Percent	1.000000	0.470825	0.137204	0.152327	0.231718	0.007925
6	Class Excess Demand - kW	901,019	616,410	122,824	82,838	73,137	5,810
7	Class Excess Demand - Percent	1.000000	0.684125	0.136317	0.091938	0.081172	0.006448
	Allocator:						
8	Annual Load Factor * Average Demand	0.470791	0.221661	0.064595	0.071714	0.109091	0.003731
9	(1-LF) * Excess Demand	<u>0.529209</u>	<u>0.362045</u>	<u>0.072140</u>	<u>0.048654</u>	<u>0.042957</u>	<u>0.003413</u>
10	Average and Excess Demand Allocator	1.000000	0.583706	0.136735	0.120369	0.152048	0.007143

Notes:

Line 4 equals Line 3 + 8.760

Line 6 equals Line 2- Line 4

System Annual Load Factor

47.08%

1 - Load Factor

52.92%

Source: KCPL Allocators MPS 05-21-10.xls

KCP&L GREATER MISSOURI OPERATIONS COMPANY
 FOR ALL TERRITORIES SERVED AS MPS
 CLASS COST OF SERVICE
 TEST YEAR 12-2009 WITH KNOWN & MEASURABLE CHANGES TO 12-31-2010

LINE NO.	DESCRIPTION	MPS RETAIL (1)	RESIDENTIAL (2)	SMALL GEN. SERVICE (3)	LARGE GEN. SERVICE (4)	LARGE PWR SERVICE (5)	LIGHTING (6)
0010	SCHEDULE 1 - SUMMARY OF OPERATING INC & RATE BASE						
0020							
0030	OPERATING REVENUE						
0040	RETAIL SALES REVENUE	525,150,206	286,123,315	77,927,755	66,598,381	85,731,870	8,768,886
0050	OTHER OPERATING REVENUE	15,351,219	8,061,765	2,019,643	2,131,658	2,977,654	160,499
0060	TOTAL OPERATING REVENUE	540,501,425	294,185,080	79,947,398	68,730,038	88,709,524	8,929,385
0070							
0080	OPERATING EXPENSES						
0090	FUEL	123,074,108	58,037,565	16,859,187	18,717,319	28,492,154	967,883
0100	PURCHASED POWER	74,560,985	35,736,974	10,128,535	11,226,479	16,904,438	564,559
0110	OTHER OPERATION & MAINTENANCE EXPENSES	153,068,760	94,275,153	21,699,609	15,965,708	17,636,742	3,491,548
0120	DEPRECIATION EXPENSES (AFTER CLEARINGS)	67,044,343	39,851,468	8,941,733	7,640,381	8,499,648	2,111,113
0130	AMORTIZATION EXPENSES	1,519,787	901,040	201,275	177,820	205,036	34,615
0140	TAXES OTHER THAN INCOME TAXES	17,199,036	10,273,667	2,329,906	1,959,746	2,210,693	425,025
0150	FEDERAL AND STATE INCOME TAXES	18,587,511	8,545,078	4,800,004	2,424,063	2,551,725	266,641
0160	TOTAL ELECTRIC OPERATING EXPENSES	455,054,530	247,620,945	64,960,250	58,111,516	76,500,435	7,861,384
0170							
0180	NET ELECTRIC OPERATING INCOME	85,446,895	46,564,135	14,987,148	10,618,523	12,209,089	1,068,000
0190							
0200	RATE BASE						
0210	TOTAL ELECTRIC PLANT	2,351,919,419	1,389,364,221	313,923,176	272,351,907	309,000,863	57,279,252
0220	LESS: ACCUM. PROV. FOR DEPREC	767,525,911	461,630,655	102,050,768	86,743,305	93,790,075	23,311,108
0230	NET PLANT	1,584,393,508	927,733,566	211,872,408	185,608,601	215,210,788	33,968,145
0240	PLUS:						
0250	CASH WORKING CAPITAL	(1,152,930)	(1,408,264)	(125,390)	56,327	450,791	(126,394)
0260	MATERIALS & SUPPLIES	27,552,314	16,393,301	3,677,554	3,190,554	3,619,890	671,016
0270	SO2 EMISSION ALLOWANCES	3,304,532	1,928,874	451,844	397,762	502,447	23,605
0280	PREPAYMENTS	1,889,742	1,124,374	252,234	218,832	248,279	46,023
0290	FUEL INVENTORY	34,305,171	16,177,152	4,699,260	5,217,189	7,941,786	269,784
0300	AAO DEF DIBLEY REB & WESTERN COAL 1990	25,852	15,090	3,535	3,112	3,931	185
0310	AAO DEF DIBLEY REB & WESTERN COAL 1992	364,421	212,715	49,829	43,865	55,409	2,603
0320	DEFERRAL OF DSM/EE COSTS	12,726,278	7,330,308	1,530,968	1,660,596	2,159,279	45,126
0330	ERPP	217,092	125,045	26,116	28,327	36,834	770
0340	IATAN 1 REGULATORY ASSET	2,598,317	1,516,652	355,280	312,756	395,068	18,561
0350	REGULATORY ASSET-ERISA MINIMUM TRACKER	8,554,384	5,310,486	1,196,888	882,070	922,956	241,984
0360	LESS:						
0370	CUSTOMER ADVANCES FOR CONSTRUCTION	5,893,381	3,637,881	791,362	612,455	518,635	333,047
0380	CUSTOMER DEPOSITS	5,740,655	287,569	5,215,969	216,383	20,324	411
0390	TOTAL ACCUMULATED DEFERRED TAXES	194,258,902	115,581,748	25,928,787	22,495,151	25,522,204	4,731,031
0400	TOTAL ACCUMULATED DEFERRED TAXES - AAO	149,826	89,145	19,998	17,350	19,685	3,649
0410	TOTAL RATE BASE	1,468,735,918	866,862,955	192,034,430	174,278,652	205,466,810	30,093,270
0420							
0430	RATE OF RETURN	5.818%	5.372%	7.804%	6.093%	5.942%	3.549%
0440	RELATIVE RATE OF RETURN	1.00	0.92	1.34	1.05	1.02	0.61

Notes:

Production Plant and Expense Allocated using A&E-2NCP.
 SFR Off System Sales and SFR Off System Sales - L&P Revenue Allocated on Energy.

**KCP&L GREATER MISSOURI OPERATIONS COMPANY
FOR ALL TERRITORIES SERVED AS MPS**

**Development of
4 CP Demand Allocator
For the Test Year Ended December 2009**

<u>Line</u>	<u>Description</u>	<u>MPS Retail (1)</u>	<u>Residential (2)</u>	<u>Small General Service (3)</u>	<u>Large General Service (4)</u>	<u>Large Power Service (5)</u>	<u>Lighting (6)</u>
1	4 CP Demand - kW	1,406,667	844,498	169,720	168,250	224,050	149
2	4 CP Demand - Percent	1.000000	0.600354	0.120654	0.119609	0.159277	0.000106

Source: KCPL Allocators MPS 05-21-10.xls

**KCP&L GREATER MISSOURI OPERATIONS COMPANY
FOR ALL TERRITORIES SERVED AS MPS
CLASS COST OF SERVICE
TEST YEAR 12-2009 WITH KNOWN & MEASURABLE CHANGES TO 12-31-2010**

LINE NO.	DESCRIPTION	MPS RETAIL (1)	RESIDENTIAL (2)	SMALL GEN. SERVICE (3)	LARGE GEN. SERVICE (4)	LARGE PWR SERVICE (5)	LIGHTING (6)
0010	SCHEDULE 1 - SUMMARY OF OPERATING INC & RATE BASE						
0020							
0030	OPERATING REVENUE						
0040	RETAIL SALES REVENUE	525,150,206	286,123,315	77,927,755	66,598,381	85,731,870	8,768,886
0050	OTHER OPERATING REVENUE	15,351,219	8,080,162	2,001,873	2,130,819	2,985,643	152,722
0060	TOTAL OPERATING REVENUE	540,501,425	294,203,477	79,929,628	68,729,199	88,717,513	8,921,608
0070							
0080	OPERATING EXPENSES						
0090	FUEL	123,074,108	58,037,565	16,859,187	18,717,319	28,492,154	967,883
0100	PURCHASED POWER	74,560,985	35,736,974	10,128,535	11,226,479	16,904,438	564,559
0110	OTHER OPERATION & MAINTENANCE EXPENSES	153,068,760	95,145,662	20,858,951	15,926,026	18,014,727	3,123,394
0120	DEPRECIATION EXPENSES (AFTER CLEARINGS)	67,044,343	40,400,372	8,411,544	7,615,340	8,738,011	1,879,076
0130	AMORTIZATION EXPENSES	1,519,787	913,742	189,006	177,240	210,552	29,246
0140	TAXES OTHER THAN INCOME TAXES	17,199,036	10,396,147	2,211,613	1,954,161	2,263,878	373,238
0150	FEDERAL AND STATE INCOME TAXES	18,587,511	7,774,373	5,544,368	2,459,210	2,217,057	592,502
0160	TOTAL ELECTRIC OPERATING EXPENSES	455,054,530	248,404,835	64,203,204	58,075,776	76,840,817	7,529,898
0170							
0180	NET ELECTRIC OPERATING INCOME	85,446,895	45,798,642	15,726,424	10,653,423	11,876,696	1,391,710
0190							
0200	RATE BASE						
0210	TOTAL ELECTRIC PLANT	2,351,919,419	1,418,456,716	295,481,314	271,480,866	317,291,928	49,208,595
0220	LESS: ACCUM. PROV. FOR DEPREC	767,525,911	467,183,497	96,687,121	86,489,966	96,201,447	20,963,880
0230	NET PLANT	1,584,393,508	951,273,219	198,794,193	184,990,900	221,090,481	28,244,716
0240	PLUS:						
0250	CASH WORKING CAPITAL	(1,152,930)	(1,469,327)	(66,402)	59,114	424,273	(100,587)
0260	MATERIALS & SUPPLIES	27,552,314	16,616,966	3,461,511	3,180,350	3,717,018	576,470
0270	SO2 EMISSION ALLOWANCES	3,304,532	1,983,888	398,704	395,252	526,337	351
0280	PREPAYMENTS	1,889,742	1,139,715	237,416	218,132	254,941	39,539
0290	FUEL INVENTORY	34,305,171	16,177,152	4,699,260	5,217,189	7,941,786	269,784
0300	AAO DEF DIBLEY REB & WESTERN COAL 1990	25,852	15,520	3,119	3,092	4,118	3
0310	AAO DEF DIBLEY REB & WESTERN COAL 1992	364,421	218,781	43,969	43,588	58,044	39
0320	DEFERRAL OF DSM/EE COSTS	12,726,278	7,330,308	1,530,968	1,660,596	2,159,279	45,126
0330	ERPP	217,092	125,045	26,116	28,327	36,834	770
0340	IATAN 1 REGULATORY ASSET	2,598,317	1,559,909	313,497	310,783	413,853	276
0350	REGULATORY ASSET-ERISA MINIMUM TRACKER	8,554,384	5,353,878	1,155,010	880,097	941,792	223,608
0360	LESS:						
0370	CUSTOMER ADVANCES FOR CONSTRUCTION	5,893,381	3,637,881	791,362	612,455	518,635	333,047
0380	CUSTOMER DEPOSITS	5,740,655	287,569	5,215,969	216,383	20,324	411
0390	TOTAL ACCUMULATED DEFERRED TAXES	194,258,902	117,158,710	24,405,545	22,423,207	26,207,012	4,064,428
0400	TOTAL ACCUMULATED DEFERRED TAXES - AAO	149,826	90,361	18,823	17,294	20,213	3,135
0410	TOTAL RATE BASE	1,468,735,918	879,150,533	180,165,662	173,718,080	210,802,571	24,899,072
0420							
0430	RATE OF RETURN	5.818%	5.209%	8.729%	6.133%	5.634%	5.589%
0440	RELATIVE RATE OF RETURN	1.00	0.90	1.50	1.05	0.97	0.96

Notes:

Production Plant and Expense Allocated using 4CP.
SFR Off System Sales and SFR Off System Sales - L&P Revenue Allocated on Energy.

KCP&L GREATER MISSOURI OPERATIONS COMPANY

Analysis of KCP&L Greater Missouri Operations Company For All Territories Served as L&P Monthly Peak Demands as a Percent of the Annual System Peak For the Test Year Ended September 2009

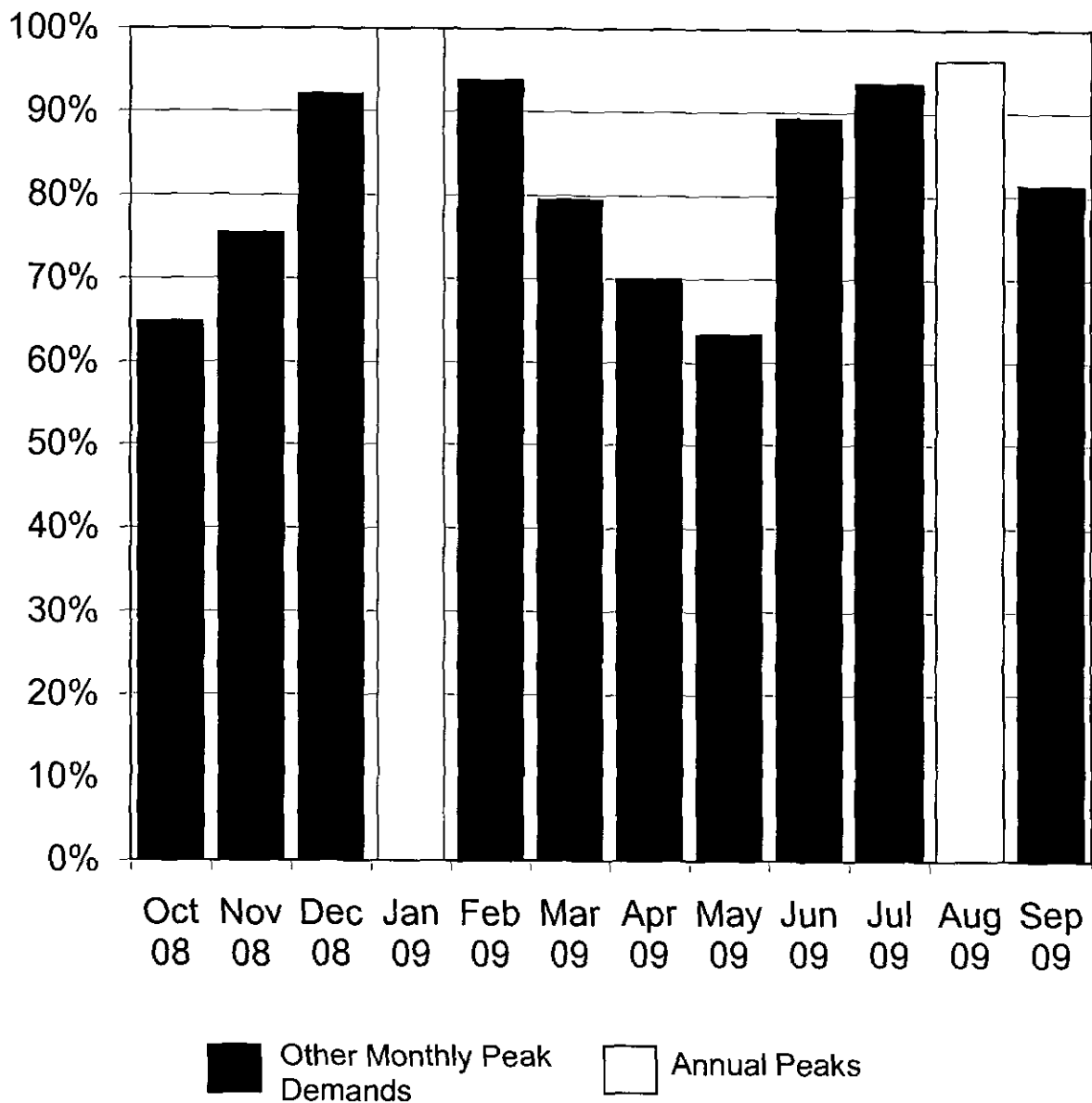

KCP&L GREATER MISSOURI OPERATIONS COMPANY

**Analysis of KCP&L Greater Missouri Operations Company
For All Territories Served as L&P
Monthly Peak Demands
as a Percent of the Annual System Peak
(Weather Normalized and with Losses)
For the Test Year Ended September 2009**

<u>Line</u>	<u>Description</u>	<u>L&P Retail MW (1)</u>	<u>Percent (2)</u>
1	January	462	100.0
2	February	434	93.9
3	March	368	79.7
4	April	324	70.1
5	May	293	63.4
6	June	413	89.4
7	July	432	93.5
8	August	445	96.3
9	September	376	81.4
10	October	300	64.9
11	November	349	75.5
12	December	426	92.2

Source: Schedule GMM2010-3

**KCP&L GREATER MISSOURI OPERATIONS COMPANY
FOR ALL TERRITORIES SERVED AS L&P**

**Development of
Average and Excess Demand Allocator
Based on 4 Non-Coincident Peaks
For the Test Year Ended December 2009**

<u>Line</u>	<u>Description</u>	<u>L&P Retail (1)</u>	<u>Residential (2)</u>	<u>General Service (3)</u>	<u>Large General Service (4)</u>	<u>Large Power Service (5)</u>	<u>Lighting (6)</u>
1	Territory System Peak - kW	461,826					
2	Avg of 4 Highest Monthly NCP Values - kW	471,871	225,883	26,733	83,691	130,038	5,527
3	Energy Sales with Losses - MWh	2,309,626	864,771	116,097	421,065	883,552	24,142
4	Average Demand - kW	263,656	98,718	13,253	48,067	100,862	2,756
5	Average Demand - Percent	1.000000	0.374420	0.050266	0.182309	0.382552	0.010453
6	Class Excess Demand - kW	208,215	127,164	13,480	35,624	29,176	2,771
7	Class Excess Demand - Percent	1.000000	0.610735	0.064739	0.171093	0.140122	0.013310
	Allocator:						
8	Annual Load Factor * Average Demand	0.570899	0.213756	0.028697	0.104080	0.218399	0.005967
9	(1-LF) * Excess Demand	<u>0.429101</u>	<u>0.262067</u>	<u>0.027780</u>	<u>0.073416</u>	<u>0.060127</u>	<u>0.005711</u>
10	Average and Excess Demand Allocator	1.000000	0.475823	0.056477	0.177496	0.278525	0.011679

Notes:

Line 4 equals Line 3 + 8.760

Line 6 equals Line 2- Line 4

System Annual Load Factor

57.09%

1 - Load Factor

42.91%

Source: KCPL Allocators L&P 05-21-10.xls

KCP&L GREATER MISSOURI OPERATIONS COMPANY
 FOR ALL TERRITORIES SERVED AS L&P
 CLASS COST OF SERVICE
 TEST YEAR 12-2009 WITH KNOWN & MEASURABLE CHANGES TO 12-31-2010

LINE NO.	DESCRIPTION	L&P RETAIL (1)	RESIDENTIAL (2)	GEN. SERVICE (3)	LARGE GEN. SERVICE (4)	LARGE PWR SERVICE (5)	LIGHTING (6)
0010	SCHEDULE 1 - SUMMARY OF OPERATING INC & RATE BASE						
0020							
0030	OPERATING REVENUE						
0040	RETAIL SALES REVENUE	159,342,556	68,495,513	11,620,789	28,692,358	47,082,064	3,451,832
0050	OTHER OPERATING REVENUE	7,164,190	3,030,482	363,142	1,272,850	2,415,749	81,966
0060	TOTAL OPERATING REVENUE	166,506,746	71,525,995	11,983,931	29,965,208	49,497,813	3,533,799
0070							
0080	OPERATING EXPENSES						
0090	FUEL	40,456,907	14,956,795	2,024,261	7,388,319	15,659,093	428,439
0100	PURCHASED POWER	25,037,394	9,512,418	1,266,987	4,557,989	9,436,625	263,374
0110	OTHER OPERATION & MAINTENANCE EXPENSES	46,674,987	24,161,535	3,483,057	7,211,972	10,209,277	1,609,147
0120	DEPRECIATION EXPENSES (AFTER CLEARINGS)	17,108,675	8,630,939	955,251	2,819,320	4,081,000	622,165
0130	AMORTIZATION EXPENSES	1,894,187	949,471	105,366	318,456	470,046	50,849
0140	TAXES OTHER THAN INCOME TAXES	5,883,837	2,968,892	348,917	974,703	1,427,025	164,301
0150	FEDERAL AND STATE INCOME TAXES	5,102,601	945,014	1,129,498	1,491,280	1,464,682	72,128
0160	TOTAL ELECTRIC OPERATING EXPENSES	142,158,587	62,125,063	9,313,337	24,762,039	42,747,746	3,210,402
0170							
0180	NET ELECTRIC OPERATING INCOME	24,348,159	9,400,932	2,670,594	5,203,170	6,750,067	323,397
0190							
0200	RATE BASE						
0210	TOTAL ELECTRIC PLANT	644,726,275	323,591,433	35,975,978	108,205,335	159,461,410	17,492,119
0220	LESS: ACCUM. PROV. FOR DEPREC	229,876,672	117,503,446	12,852,511	37,999,006	54,012,329	7,509,380
0230	NET PLANT	414,849,603	206,087,987	23,123,467	70,206,329	105,449,081	9,982,739
0240	PLUS:						
0250	CASH WORKING CAPITAL	8,050	(169,316)	26,475	(3,616)	161,932	(7,425)
0260	MATERIALS & SUPPLIES	9,343,114	4,686,900	519,600	1,569,455	2,314,190	252,969
0270	SO2 EMISSION ALLOWANCES	6,388,010	3,039,564	360,774	1,133,847	1,779,221	74,604
0280	PREPAYMENTS	9,035,541	4,695,796	618,766	1,425,654	2,016,189	279,135
0290	FUEL INVENTORY	18,659,190	6,898,246	933,612	3,407,578	7,222,153	197,601
0300	DEFERRAL OF DSM/EE COSTS	3,236,813	1,488,259	159,769	567,885	999,565	21,335
0310	ERPP	76,967	35,389	3,799	13,504	23,768	507
0320	IATAN 1 REGULATORY ASSET	1,823,220	867,531	102,969	323,614	507,813	21,293
0330	REGULATORY ASSET - ERISA MINIMUM TRACKER	192,186	100,065	13,293	30,219	42,632	5,976
0340	LESS:						
0350	CUSTOMER ADVANCES FOR CONSTRUCTION	255,692	143,152	14,333	38,100	44,664	15,443
0360	CUSTOMER DEPOSITS	1,253,581	62,796	1,139,006	47,251	4,438	90
0370	TOTAL ACCUMULATED DEFERRED TAXES	40,108,762	20,120,246	2,230,574	6,737,465	9,934,515	1,085,961
0380	TOTAL RATE BASE:	421,994,658	207,404,226	22,478,611	71,851,652	110,532,928	9,727,241
0390							
0400	RATE OF RETURN	5.770%	4.533%	11.881%	7.242%	6.107%	3.325%
0410	RELATIVE RATE OF RETURN	1.00	0.79	2.06	1.26	1.06	0.58

Note:

Production Plant and Expense Allocated using A&E-4NCP.
 SFR Off System Sales Revenue Allocated on Energy.

**KCP&L GREATER MISSOURI OPERATIONS COMPANY
FOR ALL TERRITORIES SERVED AS L&P**

**Class Cost of Service Study Results
and Revenue Adjustments to Move Each Class to Cost of Service
Using Modified ECOS at Present Rates
(\$ in Thousands)**

<u>Line</u>	<u>Rate Class</u>	<u>Current Revenues</u> (1)	<u>Current Rate Base</u> (2)	<u>Net Operating Income</u> (3)	<u>Earned ROR</u> (4)	<u>Indexed ROR</u> (5)	<u>Income @ Average Current ROR*</u> (6)	<u>Difference in Income</u> (7)	<u>Revenue Increase</u> (8)	<u>Percentage Increase</u> (9)
1	Residential	\$ 71,526	\$ 207,404	\$ 9,401	4.533%	79	\$ 11,967	\$ 2,566	\$ 4,211	5.9%
2	General Service	11,984	22,479	2,671	11.881%	206	1,297	(1,374)	(2,254)	-18.8%
3	Large General Service	29,965	71,852	5,203	7.242%	126	4,146	(1,057)	(1,735)	-5.8%
4	Large Power Service	49,498	110,533	6,750	6.107%	106	6,378	(373)	(611)	-1.2%
5	Total Lighting	<u>3,534</u>	<u>9,727</u>	<u>323</u>	3.325%	58	<u>561</u>	<u>238</u>	<u>390</u>	11.0%
6	Total	\$ 166,507	\$ 421,995	\$ 24,348	5.770%	100	\$ 24,348	\$ 0	\$ 0	0.0%

Source: Schedule MEB-COS-4

* Column 2 x Column 4, Line 6 (5.770%)

**KCP&L GREATER MISSOURI OPERATIONS COMPANY
FOR ALL TERRITORIES SERVED AS L&P**

**Recommended Cost of Service Adjustments
Using Modified ECOS at Present Rates
(\$ in Millions)**

<u>Line</u>	<u>Rate Class</u>	<u>Current Revenues</u> (1)	<u>Move 25% Toward Cost Of Service</u> (2)	<u>Adjusted Current Revenue</u> (3)	<u>Percent of Adjusted Current Revenue</u> (4)
1	Residential	\$ 71.5	\$ 1.1	\$ 72.6	43.59%
2	General Service	12.0	(0.6)	11.4	6.86%
3	Large General Service	30.0	(0.4)	29.5	17.74%
4	Large Power Service	49.5	(0.2)	49.3	29.64%
5	Total Lighting	<u>3.5</u>	<u>0.1</u>	<u>3.6</u>	2.18%
6	Subtotal	\$ 166.5	\$ -	\$ 166.5	100.00%

**KCP&L GREATER MISSOURI OPERATIONS COMPANY
FOR ALL TERRITORIES SERVED AS L&P**

**Development of
Average and Excess Demand Allocator
Based on 2 Non-Coincident Peaks
For the Test Year Ended December 2009**

<u>Line</u>	<u>Description</u>	<u>L&P Retail (1)</u>	<u>Residential (2)</u>	<u>General Service (3)</u>	<u>Large General Service (4)</u>	<u>Large Power Service (5)</u>	<u>Lighting (6)</u>
1	Territory System Peak - kW	461,826					
2	Avg of 2 Highest Monthly NCP Values - kW	481,292	233,301	26,640	84,506	131,318	5,527
3	Energy Sales with Losses - MWh	2,309,626	864,771	116,097	421,065	883,552	24,142
4	Average Demand - kW	263,656	98,718	13,253	48,067	100,862	2,756
5	Average Demand - Percent	1.000000	0.374420	0.050266	0.182309	0.382552	0.010453
6	Class Excess Demand - kW	217,636	134,583	13,387	36,439	30,456	2,771
7	Class Excess Demand - Percent	1.000000	0.618386	0.061510	0.167430	0.139940	0.012734
	Allocator:						
8	Annual Load Factor * Average Demand	0.570899	0.213756	0.028697	0.104080	0.218399	0.005967
9	(1-LF) * Excess Demand	<u>0.429101</u>	<u>0.265350</u>	<u>0.026394</u>	<u>0.071844</u>	<u>0.060048</u>	<u>0.005464</u>
10	Average and Excess Demand Allocator	1.000000	0.479106	0.055091	0.175924	0.278447	0.011432

Notes:

Line 4 equals Line 3 ÷ 8.760

Line 6 equals Line 2- Line 4

System Annual Load Factor

57.09%

1 - Load Factor

42.91%

Source: KCPL Allocators L&P 05-21-10.xls

KCP&L GREATER MISSOURI OPERATIONS COMPANY
 FOR ALL TERRITORIES SERVED AS L&P
 CLASS COST OF SERVICE
 TEST YEAR 12-2009 WITH KNOWN & MEASURABLE CHANGES TO 12-31-2010

LINE NO.	DESCRIPTION	L&P RETAIL (1)	RESIDENTIAL (2)	GEN. SERVICE (3)	LARGE GEN. SERVICE (4)	LARGE PWR SERVICE (5)	LIGHTING (6)
0010	SCHEDULE 1 - SUMMARY OF OPERATING INC & RATE BASE						
0020							
0030	OPERATING REVENUE						
0040	RETAIL SALES REVENUE	159,342,556	68,495,513	11,620,789	28,692,358	47,082,064	3,451,832
0050	OTHER OPERATING REVENUE	7,164,190	3,031,976	362,511	1,272,135	2,415,714	81,854
0060	TOTAL OPERATING REVENUE	166,506,746	71,527,489	11,983,300	29,964,493	49,497,778	3,533,686
0070							
0080	OPERATING EXPENSES						
0090	FUEL	40,456,907	14,956,795	2,024,261	7,388,319	15,659,093	428,439
0100	PURCHASED POWER	25,037,394	9,516,883	1,265,103	4,555,852	9,436,519	263,037
0110	OTHER OPERATION & MAINTENANCE EXPENSES	46,674,987	24,237,093	3,451,163	7,175,795	10,207,479	1,603,457
0120	DEPRECIATION EXPENSES (AFTER CLEARINGS)	17,108,675	8,660,835	942,631	2,805,006	4,080,288	619,914
0130	AMORTIZATION EXPENSES	1,894,187	953,063	103,850	316,736	469,960	50,578
0140	TAXES OTHER THAN INCOME TAXES	5,883,837	2,979,109	344,604	969,811	1,426,781	163,532
0150	FEDERAL AND STATE INCOME TAXES	5,102,601	884,873	1,154,884	1,520,075	1,466,112	76,657
0160	TOTAL ELECTRIC OPERATING EXPENSES	142,158,587	62,188,652	9,286,495	24,731,593	42,746,233	3,205,614
0170							
0180	NET ELECTRIC OPERATING INCOME	24,348,159	9,338,837	2,696,805	5,232,900	6,751,544	328,073
0190							
0200	RATE BASE						
0210	TOTAL ELECTRIC PLANT	644,726,275	324,797,080	35,467,063	107,628,078	159,432,727	17,401,327
0220	LESS: ACCUM. PROV. FOR DEPREC	229,876,672	117,863,132	12,700,685	37,826,790	54,003,772	7,482,293
0230	NET PLANT	414,849,603	206,933,949	22,766,379	69,801,287	105,428,955	9,919,033
0240	PLUS:						
0250	CASH WORKING CAPITAL	8,050	(172,884)	27,981	(1,908)	162,017	(7,156)
0260	MATERIALS & SUPPLIES	9,343,114	4,704,422	512,203	1,561,065	2,313,773	251,649
0270	SO2 EMISSION ALLOWANCES	6,388,010	3,060,536	351,921	1,123,806	1,778,722	73,025
0280	PREPAYMENTS	9,035,541	4,709,365	613,039	1,419,158	2,015,867	278,113
0290	FUEL INVENTORY	18,659,190	6,898,246	933,612	3,407,578	7,222,153	197,601
0300	DEFERRAL OF DSM/EE COSTS	3,236,813	1,488,259	159,769	567,885	999,565	21,335
0310	ERPP	76,967	35,389	3,799	13,504	23,768	507
0320	IATAN 1 REGULATORY ASSET	1,823,220	873,516	100,443	320,749	507,670	20,842
0330	REGULATORY ASSET - ERISA MINIMUM TRACKER	192,186	100,350	13,173	30,083	42,626	5,955
0340	LESS:						
0350	CUSTOMER ADVANCES FOR CONSTRUCTION	255,692	143,152	14,333	38,100	44,664	15,443
0360	CUSTOMER DEPOSITS	1,253,581	62,796	1,139,006	47,251	4,438	90
0370	TOTAL ACCUMULATED DEFERRED TAXES	40,108,762	20,195,468	2,198,822	6,701,449	9,932,726	1,080,297
0380	TOTAL RATE BASE	421,994,658	208,229,731	22,130,158	71,456,405	110,513,289	9,665,076
0390							
0400	RATE OF RETURN	5.770%	4.485%	12.186%	7.323%	6.109%	3.394%
0410	RELATIVE RATE OF RETURN	1.00	0.78	2.11	1.27	1.06	0.59

Notes:
 Production Plant and Expense Allocated using A&E-2NCP.
 SFR Off System Sales Revenue Allocated on Energy.

**KCP&L GREATER MISSOURI OPERATIONS COMPANY
FOR ALL TERRITORIES SERVED AS L&P**

**Development of
4 CP Demand Allocator
For the Test Year Ended December 2009**

<u>Line</u>	<u>Description</u>	<u>L&P Retail (1)</u>	<u>Residential (2)</u>	<u>General Service (3)</u>	<u>Large General Service (4)</u>	<u>Large Power Service (5)</u>	<u>Lighting (6)</u>
1	4 CP Demand - kW	443,103	223,858	21,177	72,524	125,044	500
2	4 CP Demand - Percent	1.000000	0.505205	0.047792	0.163674	0.282201	0.001128

Source: KCPL Allocators L&P 05-21-10.xls

KCP&L GREATER MISSOURI OPERATIONS COMPANY
 FOR ALL TERRITORIES SERVED AS L&P
 CLASS COST OF SERVICE
 TEST YEAR 12-2009 WITH KNOWN & MEASURABLE CHANGES TO 12-31-2010

LINE NO.	DESCRIPTION	L&P RETAIL (1)	RESIDENTIAL (2)	GEN. SERVICE (3)	LARGE GEN. SERVICE (4)	LARGE PWR SERVICE (5)	LIGHTING (6)
0010	SCHEDULE 1 - SUMMARY OF OPERATING INC & RATE BASE						
0020							
0030	OPERATING REVENUE						
0040	RETAIL SALES REVENUE	159,342,556	68,495,513	11,620,789	28,692,358	47,082,064	3,451,832
0050	OTHER OPERATING REVENUE	7,164,190	3,043,853	359,190	1,266,560	2,417,423	77,165
0060	TOTAL OPERATING REVENUE	166,506,746	71,539,366	11,979,978	29,958,918	49,499,486	3,528,997
0070							
0080	OPERATING EXPENSES						
0090	FUEL	40,456,907	14,956,795	2,024,261	7,388,319	15,659,093	428,439
0100	PURCHASED POWER	25,037,394	9,552,377	1,255,176	4,539,191	9,441,625	249,024
0110	OTHER OPERATION & MAINTENANCE EXPENSES	46,674,987	24,837,751	3,283,180	6,893,855	10,293,888	1,366,313
0120	DEPRECIATION EXPENSES (AFTER CLEARINGS)	17,108,675	8,898,504	876,163	2,693,448	4,114,479	526,081
0130	AMORTIZATION EXPENSES	1,894,187	981,622	95,863	303,331	474,069	39,303
0140	TAXES OTHER THAN INCOME TAXES	5,883,837	3,060,329	321,889	931,687	1,438,466	131,466
0150	FEDERAL AND STATE INCOME TAXES	5,102,601	406,779	1,288,590	1,744,485	1,397,335	265,411
0160	TOTAL ELECTRIC OPERATING EXPENSES	142,158,587	62,694,157	9,145,123	24,494,316	42,818,955	3,006,037
0170							
0180	NET ELECTRIC OPERATING INCOME	24,348,159	8,845,208	2,834,855	5,464,602	6,680,532	522,961
0190							
0200	RATE BASE						
0210	TOTAL ELECTRIC PLANT	644,726,275	334,381,503	32,786,630	103,129,287	160,811,523	13,617,331
0220	LESS: ACCUM. PROV. FOR DEPREC	229,876,672	120,722,491	11,901,021	36,484,648	54,415,113	6,353,399
0230	NET PLANT	414,849,603	213,659,013	20,885,610	66,644,639	106,396,410	7,263,932
0240	PLUS:						
0250	CASH WORKING CAPITAL	8,050	(201,249)	35,914	11,406	157,936	4,043
0260	MATERIALS & SUPPLIES	9,343,114	4,843,721	473,247	1,495,681	2,333,813	196,653
0270	SO2 EMISSION ALLOWANCES	6,388,010	3,227,253	305,296	1,045,551	1,802,706	7,204
0280	PREPAYMENTS	9,035,541	4,817,229	582,873	1,368,528	2,031,384	235,527
0290	FUEL INVENTORY	18,659,190	6,898,246	933,612	3,407,578	7,222,153	197,601
0300	DEFERRAL OF DSM/EE COSTS	3,236,813	1,488,259	159,769	567,885	999,565	21,335
0310	ERPP	76,967	35,389	3,799	13,504	23,768	507
0320	IATAN 1 REGULATORY ASSET	1,823,220	921,099	87,135	298,414	514,515	2,056
0330	REGULATORY ASSET - ERISA MINIMUM TRACKER	192,186	102,614	12,540	29,020	42,951	5,061
0340	LESS:						
0350	CUSTOMER ADVANCES FOR CONSTRUCTION	255,692	143,152	14,333	38,100	44,664	15,443
0360	CUSTOMER DEPOSITS	1,253,581	62,796	1,139,006	47,251	4,438	90
0370	TOTAL ACCUMULATED DEFERRED TAXES	40,108,762	20,793,458	2,031,585	6,420,761	10,018,751	844,206
0380	TOTAL RATE BASE	421,994,658	214,792,167	20,294,871	68,376,091	111,457,348	7,074,181
0390							
0400	RATE OF RETURN	5.770%	4.118%	13.968%	7.992%	5.994%	7.393%
0410	RELATIVE RATE OF RETURN	1.00	0.71	2.42	1.39	1.04	1.28

Notes:
 Production Plant and Expense Allocated using 4CP.
 SFR Off System Sales Revenue Allocated on Energy.