

**MISSOURI PUBLIC SERVICE COMMISSION**

**STAFF REPORT**  
**CLASS COST OF SERVICE**

**APPENDIX 3**

**Sarah L.K. Lange**

**(Schedule SLKL-d1)**

**and**

**(Schedule SLKL-d2)**

**THE EMPIRE DISTRICT ELECTRIC COMPANY**

**CASE NO. ER-2019-0374**

*Jefferson City, Missouri*  
*January 29, 2020*

# UNION ELECTRIC COMPANY GAS SERVICE

Applying to MISSOURI SERVICE AREA

## Delivery Charge Adjustment (DCA) Rider

### APPLICABILITY

The DCA<sup>1</sup> Rider is applicable to all Customers taking service under the Residential or General Service rate schedules. The Rider will be applied as a separate line item on a customer's bill to all Ccf of gas usage.

### FILING

The DCA rider

- (1) Adjustment Period (AP): The DCA AP will begin on the ninth billing month of a given year, and continue through the eighth billing month of the subsequent year. The initial AP under this rider shall begin on September 1, 2019. Actual Block Usage for the final billing month of an AP may be projected for purposes of a DCA rate calculation included in a filing under this Rider if necessary. Prior to the end of the subsequent twelve (12) month AP, the difference between the ABU previously projected and the observed ABU for that month, multiplied by the Rate that was in effect during that month, will be added to or subtracted from the calculation of the over- or under-billing of the DCA during the RP as appropriate.
- (2) Recovery Period (RP): An annual period during which a DCA rate is in effect, beginning with the eleventh calendar month of a given year, and continuing through the tenth calendar month of the subsequent year. The RP shall be calculated based on nine (9) months actual sales, including estimated unbilled sales for the ninth month, and three (3) months projected sales. The 3 months projected sales associated with each RP shall be trued up with actuals upon calculation of the subsequent RA.
- (3) After November 1, 2019, the Company shall file its DCA revisions with the Commission each calendar year at least sixty (60) days prior to the first day of the eleventh calendar month unless otherwise provided for by the Commission.

### RATE ADJUSTMENT CALCULATION

The DCA applicable to each rate schedule subject to this Rider and calculated separately for Residential customers and General Service customers, shall be revised annually to reflect (1) the difference between the normalized annual natural gas usage in Block 2 for Residential customers and Block 1b for General Service customers authorized in the Company's last general rate case and the actual usage billed in those blocks for the applicable AP; (2) to reconcile the over- or under-recovery from the previous DCA rate adjustment; and (3) any adjustments ordered by the Commission.

**Case No. ER-2019-0374**  
**Schedule SLKL-d1, Page 1 of 3**

<sup>1</sup> Based on the Volume Indifference Reconciliation to Normal (VIRN) initially proposed by Staff and as modified by the Stipulation and Agreement in GR-2019-0077

Issued Pursuant to the Order of the Mo.P.S.C. in Case No. GR-2019-0077.

**September 1, 2019**

DATE OF ISSUE August 16, 2019 DATE EFFECTIVE ~~September 15, 2019~~

ISSUED BY Michael Moehn President St. Louis, Missouri Address  
Name of Officer Title

FILED  
Missouri Public  
Service Commission  
GR-2019-0077; YG-2020-0032

# UNION ELECTRIC COMPANY GAS SERVICE

Applying to \_\_\_\_\_ MISSOURI SERVICE AREA

$$DCA = \left[ \frac{(RCBU - ABU) \times Rate}{RCU} + \frac{(OA + RA)}{RCU} \right]$$

Where:

- DCA = "Delivery Charge Adjustment Rate" to be calculated independently for each of the Company's applicable service classes and applied to all Ccf of the applicable service class during the RP.
- RCBU = "Rate Case Block Usage" will be the normalized annual natural gas usage in Block 2 for Residential customers and Block 1b for General Service customers established in the most recent general rate case.
- RCU = "Rate Case Usage" will be the estimated total usage in Ccf for the applicable class established in the most recent general rate case.
- ABU = "Actual Block Usage" is that usage which occurred during the Adjustment Period (AP) for the class's adjustable Ccf usage range
- Rate = The currently effective class rate for usage in Block 2 for Residential customers and Block 1b for General Service customers.
- OA = "Ordered Adjustment" is the amount of any adjustment to the DCA ordered by the Commission as a result of corrections under this Rider. Such amounts shall include monthly interest equal to the reconciliation adjustment interest rate.
- RA = "Reconciliation Adjustment" is the amount due to the Company (+RA) or Customers (-RA) arising from adjustments under this Rider that were under- or over-billed in the prior 12 month RP

In the event that there is more than one set of non-gas base rates in effect during the AP the rates and rate case block usage will be prorated accordingly.

### Reconciliation Adjustment Interest Rate

Each month, carrying costs, at a simple rate of interest equal to the prime bank lending rate (as published in The Wall Street Journal on the first business day of such month), minus two percentage points, shall be applied to the Company's ending monthly DCA balance. In no event shall the carrying cost rate be less than 0%. Corresponding interest income and expense amounts shall be recorded in account 419 and 431 on a net cumulative basis for the DCA deferral period.

### Rate Case Information

From GR-2019-0077, the normalized annual natural gas usage in Block 2 (greater than 30 ccf) for Residential customers is 44,385,230 Ccf and Block 1b (between 101 and 400 ccf) for General Service customers is 10,215,167 Ccf. The Block 2 rate for the Residential Class is \$0.3136 and the rate for Block 1b for the General Service Class is \$0.3048.

RCU: Total Residential Usage is 74,556,650, total General Service Usage 36,738,143.

**Case No. ER-2019-0374**  
**Schedule SLKL-d1, Page 2 of 3**

Issued Pursuant to the Order of the Mo.P.S.C. in Case No. GR-2019-0077.

September 1, 2019

DATE OF ISSUE August 16, 2019

DATE EFFECTIVE ~~September 15, 2019~~

ISSUED BY Michael Moehn  
Name of Officer

President  
Title

St. Louis, Missouri  
Address

FILED  
Missouri Public  
Service Commission  
GR-2019-0077; YG-2020-0032

# UNION ELECTRIC COMPANY GAS SERVICE

Applying to MISSOURI SERVICE AREA

### Delivery Charge Adjustment (DCA) Rider

The DCA (in \$/Ccf) to be applied for service on or after the first effective date and terminating on the last effective date to the Company's Residential and General Service rate schedules, as applicable, for gas sold or delivered to customers in the Company's service area.

Customer Class	First Effective Date	Last Effective Date	DCA
Residential	Effective Date of This Tariff Sheet	10/31/2020	0.0000
General Service	Effective Date of This Tariff Sheet	10/31/2020	0.0000

**Case No. ER-2019-0374**  
**Schedule SLKL-d1, Page 3 of 3**

Issued Pursuant to the Order of the Mo.P.S.C. in Case No. GR-2019-0077.

DATE OF ISSUE August 16, 2019 DATE EFFECTIVE September 1, 2019  
(Note: ~~September 15, 2019~~ is crossed out)

ISSUED BY Michael Moehn President St. Louis, Missouri  
Name of Officer Title Address



# Electric Cost Allocation for a New Era

*A Manual*

By Jim Lazar, Paul Chernick and William Marcus

Edited by Mark LeBel



JANUARY 2020

**Regulatory Assistance Project (RAP)<sup>®</sup>**

50 State Street, Suite 3  
Montpelier, VT 05602  
USA

Telephone: 802-223-8199

Email: [info@raponline.org](mailto:info@raponline.org)

[raponline.org](http://raponline.org)

[linkedin.com/company/the-regulatory-assistance-project](https://www.linkedin.com/company/the-regulatory-assistance-project)

[twitter.com/regassistproj](https://twitter.com/regassistproj)

© Regulatory Assistance Project (RAP)<sup>®</sup>. This work is licensed under a Creative Commons Attribution-NonCommercial License (CC BY-NC 4.0).

Cover photo: Felix Lipov/Shutterstock.com

**Suggested citation**

Lazar, J., Chernick, P., Marcus, W., and LeBel, M. (Ed.). (2020, January). *Electric cost allocation for a new era: A manual*. Montpelier, VT: Regulatory Assistance Project.

# Contents

Introduction and Overview .....	14
Scope and Context of This Manual .....	14
Continuing Evolution of the Electric System .....	16
Principles and Best Practices .....	18
Path Forward and Need for Reform .....	19
Guide to This Manual .....	21
<b>Part I: Economic Regulation and the Electric System in the United States</b>	
1. Economic Regulation in the U.S. ....	25
1.1 Purposes of Economic Regulation .....	25
1.2 Basic Features of Economic Regulation .....	26
1.3 Important Treatises on Utility Regulation and Cost Allocation .....	26
2. Main Elements of Rate-Making .....	28
2.1 Determining the Revenue Requirement .....	28
2.2 Cost Allocation .....	29
2.3 Rate Design .....	30
2.4 Rate Case Procedure .....	31
3. Basic Components of the Electric System .....	32
3.1 Categories of Costs .....	32
3.1.1 Generation .....	33
3.1.2 Transmission .....	35
3.1.3 Distribution .....	35
3.1.4 Line Losses .....	38
3.1.5 Billing and Customer Service .....	39
3.1.6 Public Policy Program Expenditures .....	39
3.1.7 Administrative and General Costs .....	40

3.2	Types of Utilities	40
3.2.1	Ownership Structures	40
3.2.2	Vertically Integrated Versus Restructured	41
3.2.3	Range of Typical Utility Structures	41
4.	Past, Present and Future of the U.S. Electric System	43
4.1	Early Developments	43
4.2	Rural Electrification and the Federal Power Act	44
4.3	Vertically Integrated Utilities Dominate	44
4.4	From the Oil Crisis to Restructuring	45
4.5	Opening of the 21st Century	47
	<i>Works Cited in Part I</i>	49
<b>Part II: Overarching Issues and Frameworks for Cost Allocation</b>		
5.	Key Common Analytical Elements	52
5.1	Cost Drivers	52
5.1.1	Generation	53
5.1.2	Transmission	56
5.1.3	Distribution	58
5.1.4	Incremental and Complementary Investments	60
5.2	Determining Customer Classes	61
5.3	Load Research and Data Collection	64
6.	Basic Frameworks for Cost Allocation	69
6.1	Embedded Cost of Service Studies	69
6.1.1	Functionalization	69
6.1.2	Classification	72
6.1.3	Allocation	73
6.1.4	Potential for Reform	74
6.2	Marginal Cost of Service Studies	79
6.3	Combining Frameworks	82
6.4	Using Cost of Service Study Results	82



7.	Key Issues for 21st Century Cost Allocation .....	83
7.1	Changes to Technology and the Electric System .....	83
7.1.1	Distribution System Monitoring and Advanced Metering Infrastructure .....	83
7.1.2	Variable Renewables, Storage, Energy Efficiency and Demand Response .....	84
7.1.3	Beneficial Electrification of Transportation .....	86
7.1.4	Distributed Energy Resources .....	89
7.2	Changes to Regulatory Frameworks .....	91
7.2.1	Restructuring .....	92
7.2.2	Holding Companies .....	93
7.2.3	Performance-Based Regulation Issues .....	94
7.2.4	Trackers and Riders .....	94
7.2.5	Public Policy Discounts and Programs .....	96
7.2.6	Consideration of Differential Rates of Return .....	96
7.2.7	Stranded Costs, Changed Purposes and Exit Fees .....	97
8.	Choosing Appropriate Costing Methods .....	101
	<i>Works Cited in Part II</i> .....	104
<b>Part III: Embedded Cost of Service Studies</b>		
9.	Generation in Embedded Cost of Service Studies .....	108
9.1	Identifying and Classifying Energy-Related Generation Costs .....	108
9.1.1	Insights and Approaches From Competitive Wholesale Markets .....	109
9.1.2	Classification Approaches .....	112
9.1.3	Joint Classification and Allocation Methods .....	118
9.1.4	Other Technologies and Issues .....	122
9.1.5	Summary of Generation Classification Options .....	128
9.2	Allocating Energy-Related Generation Costs .....	128
9.3	Allocating Demand-Related Generation Costs .....	130
9.4	Summary of Generation Allocation Methods and Illustrative Examples .....	132

10. Transmission in Embedded Cost of Service Studies .....	135
10.1 Subfunctionalizing Transmission .....	135
10.2 Classification .....	137
10.3 Allocation Factors .....	139
10.4 Summary of Transmission Allocation Methods and Illustrative Examples .....	140
11. Distribution in Embedded Cost of Service Studies .....	142
11.1 Subfunctionalizing Distribution Costs .....	142
11.2 Distribution Classification .....	145
11.3 Distribution Demand Allocators .....	150
11.3.1 Primary Distribution Allocators .....	150
11.3.2 Relationship Between Line Losses and Conductor Capacity .....	153
11.3.3 Secondary Distribution Allocators .....	153
11.3.4 Distribution Operations and Maintenance Allocators .....	155
11.3.5 Multifamily Housing and Distribution Allocation .....	155
11.3.6 Direct Assignment of Distribution Plant .....	156
11.4 Allocation Factors for Service Drops .....	156
11.5 Classification and Allocation for Advanced Metering and Smart Grid Costs .....	156
11.6 Summary of Distribution Classification and Allocation Methods and Illustrative Examples .....	158
11.6.1 Illustrative Methods and Results .....	159
12. Billing and Customer Service in Embedded Cost of Service Studies .....	162
12.1 Billing and Meter Reading .....	162
12.2 Uncollectible Accounts Expenses .....	162
12.3 Customer Service and Assistance .....	163
12.4 Sales and Marketing .....	164
13. Administrative and General Costs in Embedded Cost of Service Studies .....	165
13.1 Operations and Maintenance Costs in Overhead Accounts .....	165
13.2 Labor-Related Overhead Costs .....	165

13.3	Plant-Related Overhead	165
13.4	Regulatory Commission Expenses	166
13.5	Administrative and Executive Overhead	166
13.6	Advertising and Donations	166
14.	Other Resources and Public Policy Programs in Embedded Cost of Service Studies	167
14.1	Energy Efficiency Programs	167
14.2	Demand Response Program and Equipment Costs	169
14.3	Treatment of Discounts and Subsidies	170
15.	Revenues and Offsets in Embedded Cost of Service Studies	171
15.1	Off-System Sales Revenues	171
15.2	Customer Advances and Contributions in Aid of Construction	171
15.3	Other Revenues and Miscellaneous Offsets	172
16.	Differential Treatment of New Resources and New Loads	173
16.1	Identifying a Role for Differential Treatment	173
16.2	Illustrative and Actual Examples of Differential Treatment	175
16.2.1	Real-World Examples	176
17.	Future of Embedded Cost Allocation	179
	<i>Works Cited in Part III</i>	182
<b>Part IV: Marginal Cost of Service Studies</b>		
18.	Theory of Marginal Cost Allocation and Pricing	189
18.1	Development of Marginal Cost of Service Studies	190
18.2	Marginal Costs in an Oversized System	193
18.3	Impact of New Technology on Marginal Cost Analysis	194
18.3.1	Renewable Energy	194
18.3.2	Other New Technologies	194
18.4	Summary	195

19. Generation in Marginal Cost of Service Studies . . . . .	196
19.1 Long-Run Marginal Cost of Generation . . . . .	196
19.2 Short-Run Marginal Energy Costs . . . . .	197
19.3 Short-Run Marginal Generation Capacity Costs . . . . .	199
20. Transmission and Shared Distribution in Marginal Cost of Service Studies . . . . .	202
20.1 Marginal Transmission Costs . . . . .	202
20.2 Marginal Shared Distribution Costs . . . . .	203
21. Customer Connection and Service in Marginal Cost of Service Studies . . . . .	207
21.1 Traditional Computation Methods . . . . .	207
21.2 Smart Meter Issues . . . . .	208
21.3 Operations and Maintenance Expenses for Customer Connection . . . . .	209
21.4 Billing and Customer Service Expenses . . . . .	210
21.5 Illustrative Marginal Customer Costs . . . . .	211
22. Administrative and General Costs in Marginal Cost of Service Studies . . . . .	214
23. Public Policy Programs . . . . .	215
24. Reconciling Marginal Costs to Embedded Costs . . . . .	216
25. Cutting-Edge Marginal Cost Approaches . . . . .	218
25.1 Total Service Long-Run Incremental Cost . . . . .	218
25.1.1 Generation . . . . .	219
25.1.2 Transmission . . . . .	220
25.1.3 Shared Distribution . . . . .	220
25.1.4 Customer Connection, Billing and Service Costs . . . . .	221
25.2 Hourly Marginal Cost Methods . . . . .	221
25.2.1 Energy and Generation . . . . .	222
25.2.2 Transmission and Shared Distribution . . . . .	222

26. Summary of Recommendations for Marginal Cost of Service Studies .....	224
26.1 Improving Marginal Cost Methods.....	224
26.2 Moving Toward Broader Reform.....	224
<i>Works Cited in Part IV</i> .....	226
<b>Part V: After the Cost of Service Study</b>	
27. Using Study Results to Allocate the Revenue Requirement.....	230
27.1 Role of the Regulator Versus Role of the Analyst .....	230
27.2 Presenting Embedded Cost of Service Study Results .....	230
27.3 Presenting Marginal Cost of Service Study Results .....	232
27.4 Gradualism and Non-Cost Considerations.....	237
28. Relationship Between Cost Allocation and Rate Design .....	240
28.1 Class Impacts Versus Individual Customer Impacts .....	240
28.2 Incorporation of Cost Allocation Information in Rate Design.....	241
28.3 Other Considerations in Rate Design .....	242
<i>Works Cited in Part V</i> .....	244
Conclusion .....	245
Appendix A: FERC Uniform System of Accounts .....	247
Appendix B: Combustion Turbine Costs Using a Real Economic Carrying Charge Rate .....	250
Appendix C: Inconsistent Calculation of Kilowatts in Marginal Cost Studies .....	252
Appendix D: Transmission and Distribution Replacement Costs as Marginal Costs.....	253
Appendix E: Undervaluation of Long-Run Avoided Generation Costs in the NERA Method .....	255
Glossary.....	256

## Acknowledgments

Editorial assistance was provided by Ruth Hare, Camille Kadoch, Donna Brutkoski and Tim Simard.

The authors wish to express their appreciation to the following people — many of whom are former state utility commissioners — for providing helpful insights into early drafts of this manual:

- Ron Binz, Public Policy Consulting
- John Colgan, Colgan Consulting
- Mike Florio, Gridworks
- Jeff Goltz, Cascadia Law Group
- Renz Jennings
- Douglas Jester, 5 Lakes Energy
- Carl Linvill, RAP
- David Littell, RAP
- Karl Rábago, Pace Energy and Climate Center
- Rich Sedano, RAP
- John Shenot, RAP
- Frederick Weston, RAP
- Melissa Whited, Synapse Energy Economics
- Tim Woolf, Synapse Energy Economics

The authors also thank Jonathan Wallach of Resource Insight Inc. for his contribution to this effort.

In preparing this manual, the authors drew inspiration from the work and ideas of many others in addition to those discussed within. They include:

- Peter Bradford
- Eugene Coyle
- Phil Jones
- Sharon Nelson
- Tom Power
- George Sterzinger
- John Stutz

That said, responsibility for the information and views set out in this work lies entirely with the authors.

## About the Authors

Jim Lazar, senior advisor with the Regulatory Assistance Project, is an economist who studied economics and energy at Western Washington University and the University of Washington. He has maintained a consulting practice in utility regulation and pricing and has made more than 100 appearances as an expert witness in rate proceedings in many different jurisdictions. His first utility rate proceeding was in 1974. As a RAP senior advisor, he has advised utility regulators across the United States and in Europe, India, Asia, Africa and South America. He is a former member of the U.S. Department of Energy Electricity Advisory Committee. Mr. Lazar has published more than 20 reference handbooks and topical papers on utility regulation and planning.

Paul Chernick, president of Resource Insight Inc., studied technology and policy at the Massachusetts Institute of Technology. He has advised clients on a wide range of issues, including restructuring policy; estimation of stranded costs; market price forecasts; market valuation of generation resources and divestiture of generation assets; planning and rate-making for central supply, energy efficiency, renewable and distributed resources, and least-cost compliance with environmental regulations; cost allocation and rate design; transmission and distribution planning; and valuation of environmental externalities. Mr. Chernick has testified in more than 300 regulatory and judicial proceedings. He began his career in 1977 with the Massachusetts attorney general's office.

William Marcus, principal of MCPM Economics — a successor company to JBS Energy Inc., where he worked for 32 years — studied economics at Harvard University and the University of Toronto. He began his energy career with the California Energy Commission in 1978. Mr. Marcus has more than 40 years of experience analyzing utility resource plans, costs and rates. He has prepared cost and rate studies for numerous clients and has testified as an expert witness in more than 40 jurisdictions.

Taken together, the three authors have more than 120 years of experience in cost allocation and rate design issues. They have been qualified and testified as expert witnesses before 43 state utility regulatory agencies, eight Canadian provinces and many other local, state and federal regulatory bodies.

## About the Editor

Mark LeBel, associate at the Regulatory Assistance Project, has more than a decade of experience working on the overlapping economics and law of energy and environmental policy in the United States. As a member of RAP's U.S. team, he focuses on rate design and regulatory reform, including compensation for distributed energy resources, the evolution of the electricity system and beneficial electrification.

## Figures

Figure 1. Simplified rate-making process . . . . .	15
Figure 2. Traditional embedded cost of service study flowchart . . . . .	16
Figure 3. Increase in US wind and solar generation from 2008 to 2018 . . . . .	17
Figure 4. Modern embedded cost of service study flowchart . . . . .	20
Figure 5. Sankey diagram for traditional embedded cost of service study . . . . .	22
Figure 6. Sankey diagram for modern embedded cost of service study . . . . .	23
Figure 7. Illustrative traditional electric system . . . . .	32
Figure 8. Illustrative modern electric system . . . . .	33
Figure 9. Underground distribution circuit with radial secondary lines . . . . .	37
Figure 10. Detail of underground distribution circuit with networked secondary lines . . . . .	37
Figure 11. Secondary distribution pole layout . . . . .	38
Figure 12. Electric delivery system line losses . . . . .	38
Figure 13. Pearl Street Station, first commercial power plant in the United States . . . . .	43
Figure 14. Investor-owned electric utility service territories in Texas . . . . .	45
Figure 15. US average retail residential electricity prices through 2018 . . . . .	46
Figure 16. Permissible overload for varying periods . . . . .	57
Figure 17. Summer peak day load from 10 residential customers on one line transformer. . . . .	59
Figure 18. Traditional embedded cost of service study flowchart . . . . .	70
Figure 19. Modern embedded cost of service study flowchart . . . . .	73
Figure 20. Sankey diagram for legacy embedded cost of service study . . . . .	76
Figure 21. Sankey diagram for modern embedded cost of service study . . . . .	77
Figure 22. Customer behavior in Sacramento Municipal Utility District pricing pilot . . . . .	84
Figure 23. Evolution of system load in Hawaii on typical June weekday . . . . .	85
Figure 24. Illustrative Texas wind and solar resource compared with load shape . . . . .	86
Figure 25. Forecasts of electric vehicle share of sales . . . . .	86
Figure 26. Estimated grid integration costs for electric vehicles. . . . .	87
Figure 27. US solar photovoltaic installations. . . . .	90
Figure 28. Substation backfeeding during high solar hours . . . . .	91
Figure 29. Projections for US coal generating capacity . . . . .	97



Figure 30. ERCOT load and real-time prices in 2017 . . . . .	110
Figure 31. Capacity revenue percentage in relation to capacity factor in PJM . . . . .	111
Figure 32. Cost of combustion turbine plant in service in 2011 . . . . .	115
Figure 33. Simplified generation dispatch duration illustrative example . . . . .	119
Figure 34. Illustrative customer class load in each hour . . . . .	119
Figure 35. Illustration of decomposition approach to allocating resource mix . . . . .	122
Figure 36. Transmission east of San Francisco Bay . . . . .	136
Figure 37. Transmission system with uniformly distributed demand and generation . . . . .	138
Figure 38. Transmission system with remote and centralized generation . . . . .	139
Figure 39. Stub pole used to guy a primary pole . . . . .	144
Figure 40. San Diego Gas & Electric circuit peaks . . . . .	150
Figure 41. Month and hour of Delmarva Power & Light substation peaks in 2014 . . . . .	151
Figure 42. Typical utility estimates of diversity in residential loads . . . . .	154
Figure 43. US load growth by customer class since 1990 . . . . .	174
Figure 44. Estimated revenue and cost from serving additional electric vehicle load . . . . .	175
Figure 45. Daily dispatch for illustrative hourly allocation example . . . . .	179
Figure 46. Class loads for illustrative hourly allocation example . . . . .	180
Figure 47. Comparison of temporal distributions for combustion turbine cost recovery . . . . .	251

## Tables

Table 1. Types of meters and percentage of customers with each in 2017 .....	18
Table 2. Cost drivers for power supply .....	56
Table 3. Cost drivers for transmission.....	58
Table 4. Cost drivers for distribution .....	60
Table 5. Illustrative load research data .....	66
Table 6. Simple allocation factors derived from illustrative load research data .....	67
Table 7. Composite allocation factors derived from illustrative load research data.....	68
Table 8. 1992 NARUC cost allocation manual classification.....	72
Table 9. Results of two illustrative embedded cost of service study approaches .....	74
Table 10. Illustrative allocation factors .....	75
Table 11. Illustrative marginal cost results by element.....	80
Table 12. Cost components of conventional generation, 2018 midpoint estimates.....	109
Table 13. Energy portion of 2017 net revenue for New York ISO.....	111
Table 14. Equivalent peaker method analysis using replacement cost estimates .....	116
Table 15. Equivalent peaker method analysis using 2017 gross plant in service .....	117
Table 16. Equivalent peaker method classification of nonfuel operations and maintenance costs .....	117
Table 17. Class share of each generation type under probability-of-dispatch allocation.....	120
Table 18. Allocation of 400 MWs excess capacity to reflect load risk.....	124
Table 19. Attributes of generation classification options.....	129
Table 20. Illustrative example of energy-classified cost per MWh by time of use .....	129
Table 21. Illustrative example of time-of-use allocation of energy-classified costs .....	130
Table 22. Attributes of generation demand allocation options .....	132
Table 23. Summary of conceptual generation classification by technology .....	132
Table 24. Summary of generation allocation approaches.....	133
Table 25. Illustrative annual generation data.....	134
Table 26. Allocation of generation capacity costs by traditional methods .....	134
Table 27. Modern hourly allocation of generation capacity costs .....	134
Table 28. Summary of transmission classification and allocation approaches .....	141
Table 29. Illustrative allocation of transmission costs by different methods .....	141

Table 30. Residential shared transformer example . . . . .	155
Table 31. Smart grid cost classification. . . . .	157
Table 32. Summary of distribution allocation approaches . . . . .	158
Table 33. Illustrative allocation of distribution substation costs by different methods . . . . .	159
Table 34. Illustrative allocation of primary distribution circuit costs by different methods. . . . .	160
Table 35. Illustrative allocation of distribution line transformer costs by different methods . . . . .	160
Table 36. Illustrative allocation of customer-related costs by different methods . . . . .	161
Table 37. Illustrative cost study with differential treatment of new resources . . . . .	176
Table 38. Bonneville Power Administration rate summary, October 2017 to September 2019. . . . .	177
Table 39. Hourly class load share and resource output. . . . .	181
Table 40. Class shares of resource cost responsibilities and load. . . . .	181
Table 41. Illustrative example of allocating marginal distribution demand costs by two methods. . . . .	192
Table 42. Illustrative example of new-customer-only method for marginal customer costs. . . . .	212
Table 43. Illustrative example of rental method for marginal customer costs . . . . .	213
Table 44. Illustrative comparison of rental versus new-customer-only method for overall distribution costs. . . . .	213
Table 45. Computing class rate of return in an embedded cost study . . . . .	231
Table 46. Illustrative marginal cost results by element . . . . .	232
Table 47. Illustrative load research data for marginal cost of service study . . . . .	232
Table 48. Illustrative marginal cost revenue requirement . . . . .	233
Table 49. EPMC adjustment where revenue requirement less than marginal cost . . . . .	233
Table 50. EPMC adjustment where revenue requirement more than marginal cost. . . . .	234
Table 51. Illustrative functionalized equal percentage of marginal cost results . . . . .	234
Table 52. Total EPMC results with lower marginal generation costs. . . . .	235
Table 53. Functionalized EPMC example with lower marginal generation costs . . . . .	235
Table 54. Residential embedded cost responsibility across four scenarios . . . . .	236
Table 55. Use of inverse elasticity rule . . . . .	236
Table 56. Consideration of multiple cost of service studies . . . . .	237

# Introduction and Overview

The purpose of this manual is to provide a comprehensive reference on electric utility **cost allocation** for a wide range of practitioners, including utilities, intervenors, utility regulators and other policymakers. Cost allocation is one of the major steps in the traditional regulatory process for setting utility rates. In this step, the regulators are primarily determining how to equitably divide a set amount of costs, typically referred to as the **revenue requirement**, among several broadly defined classes of ratepayers. The predominant impact of different cost allocation techniques is which group of customers pays for which costs. In many cases, this is the share of costs paid by residential customers, commercial customers and industrial customers.

In addition, the data and analytical methods used to inform cost allocation are often relevant to the final step of the traditional regulatory process, known as **rate design**. In this final step, the types of charges for each class of ratepayers are determined — which can include a per-month charge; charges per **kilowatt-hour (kWh)**, which can vary by season and time of day; and different charges based on measurements of **kilowatt (kW) demand** — as well as the price for each type of charge. As a result, cost allocation decisions and analytical techniques can have additional efficiency implications.

Cost allocation has been addressed in several important books and manuals on utility regulation over the past 60 years, but much has changed since the last comprehensive publication on the topic — the 1992 *Electric Utility Cost Allocation Manual* from the **National Association of Regulatory Utility Commissioners (NARUC)**. Although these works and historic best practices are foundational, the legacy methods of cost allocation from the 20th century are no more suited to the new realities of the 21st century than the engineering of internal combustion engines is to the design of new electric motors. New electric vehicles (EVs) may look similar on the outside, but the design under the hood is completely different. This handbook both describes the current

Charting a new path on cost allocation is an important part of creating the fair, efficient and clean electric system of the future.

best practices that have been developed over the past several decades and points toward needed innovations. The authors of this manual believe strongly that charting a new path forward on cost allocation is an important part of creating the fair, efficient and clean electric system of the future.

## Scope and Context of This Manual

This manual focuses on cost allocation practices for electric utilities in the United States and their implications. Our goal is to serve as both a practical and theoretical guide to the analytical techniques involved in the equitable distribution of electricity costs. This includes background on regulatory processes, purposes of regulation, the development of the electricity system in the United States, current best practices for cost allocation and the direction that cost allocation processes should move. Most of the elements of this manual will be applicable elsewhere in the Americas, as well as in Europe, Asia and other regions.

The rate-making process for **investor-owned utilities (IOUs)** has three steps: (1) determining the annual revenue requirement, (2) allocating the costs of the revenue requirement among the defined rate classes and (3) designing the rates each customer ultimately will pay. Figure 1 on the next page presents a highly simplified version of these steps.

In the cost allocation step, there are two major quantitative frameworks used around the United States: **embedded cost of service studies** and **marginal cost of service studies**. Embedded cost studies typically are based on a single year-long period, using the embedded cost revenue requirement and customer usage patterns in that year to divide up costs.

Figure 1. Simplified rate-making process

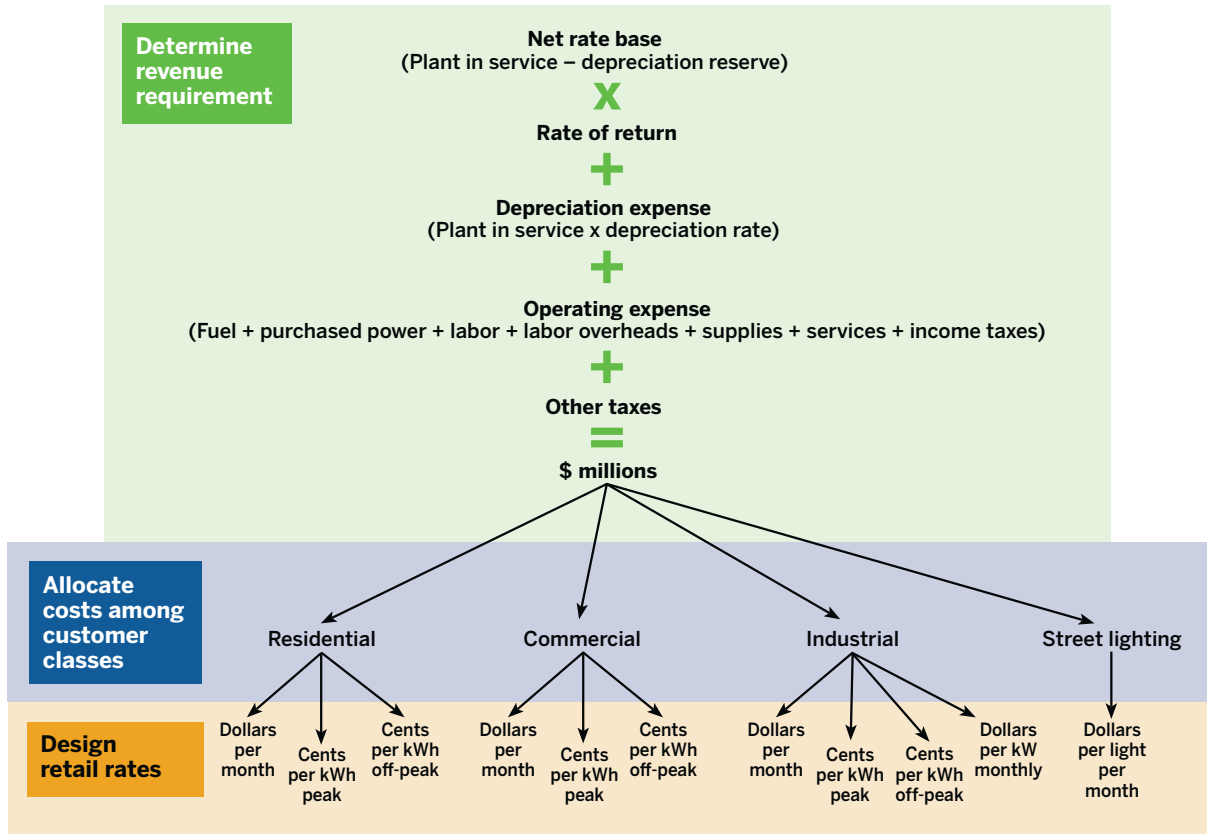

Marginal cost of service studies, in contrast, look at how costs are changing over time in response to changes in customer usage.

Regardless of which framework will be used, an enormous amount of data is typically collected first, starting with the costs that make up the revenue requirement, **energy** usage by **customer class** and measurements of demand at various times and often extending to data on **generation** patterns. Furthermore, when the quantitative **cost of service study** is completed, regulators typically don't take the results as the final word, often making adjustments for a wide range of policy considerations after the fact.

Traditionally, the analysis for an embedded cost of service study is itself divided into three parts: **functionalization**, **classification** and **allocation**. Figure 2 on the next page shows the traditional flowchart for this process.

The analysis for a marginal cost of service study starts with a similar functionalization step, but that is followed by estimation of marginal unit costs for each element of the system, calculation of a **marginal cost revenue requirement** (MCRR) for each class as well as for the system as a whole, and then **reconciliation** with the annual embedded cost revenue requirement.

This cost allocation manual is intended to build upon previous works on the topic and to illuminate several areas where the authors of this manual disagree with the approaches of the previous publications. Important works include:

- *Principles of Public Utility Rates* by James C. Bonbright (first edition, 1961; second edition, 1988).
- *Public Utility Economics* by Paul J. Garfield and Wallace F. Lovejoy (1964).

Figure 2. Traditional embedded cost of service study flowchart

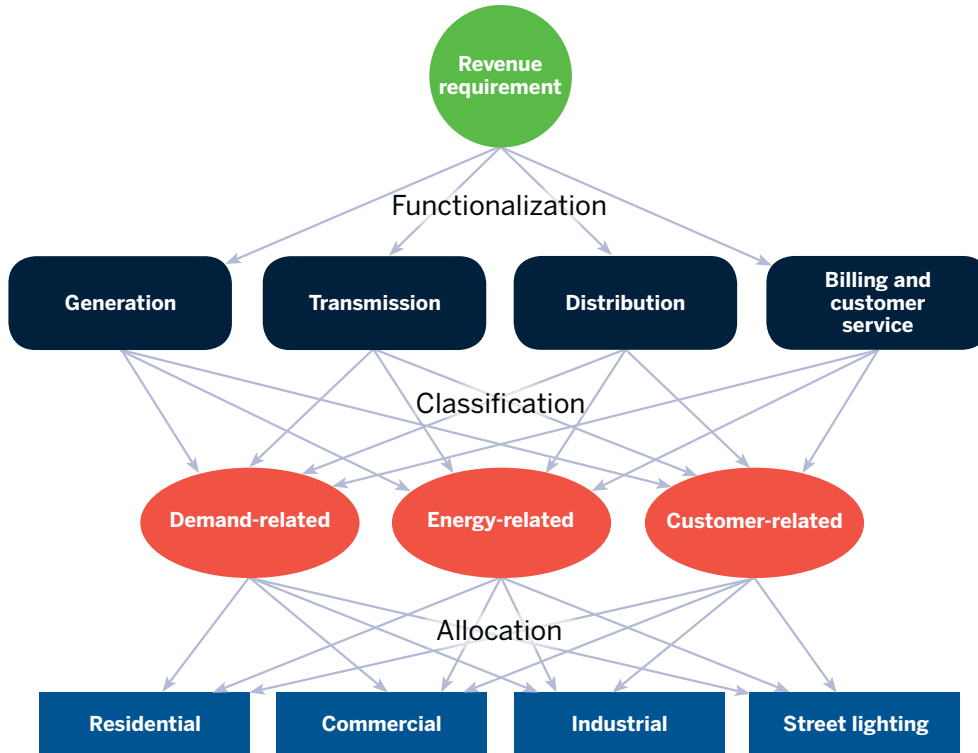

- *The Economics of Regulation: Principles and Institutions* by Alfred E. Kahn (first edition Volume 1, 1970, and Volume 2, 1971; second edition, 1988).
- *The Regulation of Public Utilities* by Charles F. Phillips (1984).
- The 1992 NARUC *Electric Utility Cost Allocation Manual*.  
Of course, cost allocation has been touched upon in other works, including RAP's publication *Electricity Regulation in the United States: A Guide* by Jim Lazar (second edition, 2016). However, since the 1990s, there has been neither a comprehensive treatment of cost allocation nor one that addresses the emerging issues of the 21st century. This manual incorporates the elements of these previous works that remain relevant, while adding new cost centers, new operating regimes and new technologies that today's cost analysts must address.

## Continuing Evolution of the Electric System

Since the establishment of electric utility regulation in the United States in the early 20th century, the electric system has undergone periods of great change every several decades. Initial provision of electricity service in densely populated areas was followed by widespread rural electrification in the 1930s and 1940s. In the 1950s and 1960s, **vertically integrated utilities**, owning generation, **transmission** and **distribution** simultaneously, were the overwhelmingly dominant form of electricity service across the entire country.

However, the oil crisis in the 1970s sparked a chain reaction in the electric industry. That included a new focus by utilities on **baseload generation** plants, typically using coal or nuclear power. At the same time, the federal government began to open up competition in the electric system with the passage of the **Public Utilities Regulatory Policy Act (PURPA)**

of 1978. PURPA dictated that each state utility commission consider a series of standards to reform rate-making practices, including **cost of service**.<sup>1</sup> Nearly every state adopted the recommendation that rates should be based on the cost of service, but neither PURPA nor state regulators were clear about what that should mean. This has led to a fertile legal and policy discussion about the cost of service, how to calculate it and how to use it. PURPA also required that utilities pay for power from **independent power producers** on set terms.

In the 1970s and early 1980s, major increases in oil prices, the completion of expensive capital investments in coal and nuclear generation facilities and general inflation all led to significantly higher electricity prices across the board. These higher prices, in combination with PURPA's requirement for set compensation to independent power producers, led to demands by major consumers to become wholesale purchasers of electricity. This in turn led to the Energy Policy Act of 1992, which enabled the broader restructuring of the electric industry in much of the country around the turn of the 20th century.

The key texts and most of the analytical principles currently used for cost allocation were developed between the 1960s and early 1990s. Since that time, the electric system in the United States has been undergoing another period of dramatic change. That includes a wide range of interrelated advancements in technology, policy and economics:

- Major advances in data collection and analytical capabilities.
- Restructuring of the industry in many parts of the country, including new wholesale electricity markets, new retail markets and new market participants.
- New consumer interests and technologies that can be deployed **behind the meter**, including clean **distributed generation, energy efficiency, demand response**, storage and other energy management technologies.
- Dramatic shifts in the relative cost of technologies and fuels, including massive declines in the price of **variable renewable resources** like wind and solar and sharp declines in the cost of energy storage technologies.
- The potential for beneficial electrification of end uses

**Figure 3. Increase in US wind and solar generation from 2008 to 2018**

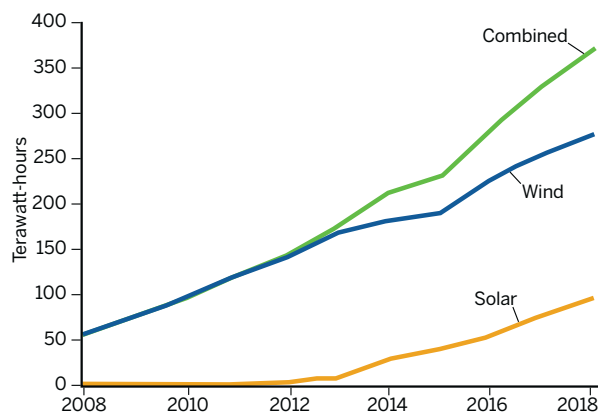

Data source: U.S. Energy Information Administration. (2019, February). *Electric Power Monthly*, Table 1.1.A. Retrieved from [https://www.eia.gov/electricity/monthly/epm\\_table\\_grapher.php?t=epmt\\_1\\_01\\_a](https://www.eia.gov/electricity/monthly/epm_table_grapher.php?t=epmt_1_01_a)

that currently run directly on fossil fuels — for example, electric vehicles in place of vehicles with internal combustion engines.

Many, if not all, of these changes have quantifiable elements that can and should be incorporated directly into the regulatory process, including cost allocation. The increased development of renewable energy and the proliferation of more sophisticated meters provide two examples.

Figure 3 illustrates the dramatic increase in wind and solar generation in the United States in the last decade, based on data from the U.S. Energy Information Administration.

Traditional cost allocation techniques classify all utility costs as **energy-related, demand-related** or **customer-related**. These categories were always simplifications, but they must be reevaluated given new developments. Some legacy cost allocation methods would have treated wind and solar generation entirely as a demand-related cost simply because they are capital investments without any variable **fuel costs**. However, wind and solar generation does not necessarily provide firm **capacity** at peak times as envisioned by the legacy frameworks, and it displaces the need for fuel supply, so it doesn't fit as a demand-related cost.

<sup>1</sup> The PURPA rate-making standards are set forth in 16 U.S.C. § 2621. Congress in 2005 adopted a specific requirement that cost of service studies take time of usage into account; this is set forth in 16 U.S.C. § 2625.

**Table 1. Types of meters and percentage of customers with each in 2017**

	Residential	Commercial	Industrial
<b>Advanced metering infrastructure</b>	52.2%	50.0%	44.5%
<b>Automated meter reading</b>	29.5%	26.5%	28.0%
<b>Older systems</b>	18.3%	23.5%	27.5%

Data source: U.S. Energy Information Administration. *Annual Electric Power Industry Report, Form EIA-861: 2017* [Data file]. Retrieved from <https://www.eia.gov/electricity/data/eia861/>

In addition, many utilities now collect much more granular data than was possible in the past, due to the widespread installation of **advanced metering infrastructure** (AMI) in many parts of the country and other advancements in the monitoring of the electric system. As a result, utility analysts often have access to historical hourly usage data for the entire utility system, each distribution **circuit**, each customer class and, increasingly, each customer. Some **automated meter reading** (AMR) systems also allow the collection of hourly data, typically read once per billing cycle. Table 1 shows the recent distribution of meter types across the country, based on data from the U.S. Energy Information Administration. Improved data collection allows for a wide range of new cost allocation techniques.

In addition, meters have been primarily treated as a customer-related cost in older methods because their main purpose was customer billing. However, advanced meters serve a broader range of functions, including demand management, which in turn provides system capacity benefits, and **line loss** reduction, which provides a system energy benefit. This means the benefits of these meters flow beyond individual customers, and logically so should responsibility for the costs.

These are just two examples of how recent technological advances affect appropriate cost allocation. In subsequent chapters, this manual will address each major cost area for electric utilities, the changes that have occurred in how costs are incurred and how assets are used, and the best methods for cost allocation.

## Principles and Best Practices

There is general agreement that the overarching goal of cost allocation is equitable division of costs among customers. Unfortunately, that is where the agreement ends and the arguments begin. Two primary conceptual principles help guide the way to the right answers:

1. Cost causation: Why were the costs incurred?
2. Costs follow benefits: Who benefits?

In some cases these two frameworks point to the same answer, but in other cases they conflict. The authors of this manual believe that “costs follow benefits” is usually, but not always, the superior principle. Other helpful questions can be asked to illuminate the details of particularly difficult questions, such as:

- If certain resources were not available, which services would not be provided, and what different resources would be needed to provide those services at least cost?
- If we did not serve this need in this way, how would costs change?

In the end, cost allocation may be more of an art than a science, since fairness and equity are often in the eye of the beholder. In most situations, cost allocation is a zero-sum process where lower costs for any one group of customers lead to higher costs for another group. However, the techniques used in cost allocation have been designed to mediate these disputes between competing sets of interests. Similarly, the data and analysis produced for the cost allocation process can also provide meaningful information to assist in rate design, such as the seasons and hours when costs are highest and lowest, categorized by system component as well as by customer class.

In that spirit, we would like to highlight the following current best practices discussed at more length in the later chapters of this manual. To begin, there are best practices that apply to both embedded and marginal cost of service studies:

- Treat as customer-related only those costs that actually vary with the number of customers, generally known as the **basic customer method**.
- Apportion all shared generation, transmission and distribution assets and the associated operating expenses



- on measures of usage, both energy- and demand-based.
- Ensure broad sharing of overhead investments and **administrative and general (A&G) costs**, based on usage metrics.
- Eliminate any distinction between “**fixed**” costs and “variable” costs, as capital investments (including new technology and data acquisition) are increasingly substitutes for fuel and other short-run variable operating costs.
- Where future costs are expected to vary significantly from current costs, make the cost trajectory an important consideration in the apportionment of costs.

Second, there are current best practices specific to embedded cost of service studies:

- Classify and allocate generation capacity costs using a time-differentiated method, such as the **probability-of-dispatch** or **base-intermediate-peak** (BIP) methods, or classify capacity costs between energy and demand using the **equivalent peaker method**.
- Allocate demand-related costs for generation using a broad peak measure, such as the **highest 100 hours** or the **loss-of-energy expectation**.
- Classify and allocate the costs of transmission based on its purpose, with any demand-related costs allocated based on broad peak periods for regional networks and narrower ones for local networks.
- Classify distribution costs using the basic customer method, and divide the vast majority of costs between demand-related and energy-related using an energy-weighted method, such as the **average-and-peak method** that many natural gas utilities use.
- Allocate demand-related distribution costs using appropriately broad peak measures that capture the hours with high usage for the relevant system elements while appropriately accounting for **diversity** in customer usage.
- Ensure that customer connection and service costs appropriately reflect differences between customer classes by using either specific cost studies for each element or a weighted customer approach.
- Functionalize and classify AMI and billing systems according to their multiple benefits across different elements and aspects of the electric system.

Lastly, there are current best practices for marginal cost of service studies:

- Use **long-run marginal costs** for generation that reflect lower greenhouse gas emissions than the present system, and recognize the costs of emissions that do occur as **marginal costs** during those periods.
- Analyze whether demand response, storage or market capacity purchases are cheaper than a traditional peaking **combustion turbine** as the foundation of marginal generation capacity cost.
- Use an expansive definition of marginal costs for transmission and distribution, including automation, controls and other investments in avoiding capacity or increasing reliability, and consider including replacement costs over the relevant timeframe.
- Recognize marginal line losses in each period.
- Functionalize marginal costs in **revenue reconciliation**; use the **equal percentage of marginal cost** technique by function, not in total.

## Path Forward and Need for Reform

Our power system is changing, and cost allocation methods must also change to reflect what we are experiencing. Key changes in the power system that have consequences for how we allocate costs include:

- Renewable resources are replacing fossil generation, substituting invested capital in place of variable fuel costs.
- **Peaking resources** are increasingly located near **load** centers, eliminating the need for transmission line investment to meet **peak demand**. Long transmission lines are often needed to bring baseload coal and nuclear resources, and to bring wind and other renewable resources, even if they may have limited peaking value relative to their total value to the power system.
- Storage is a new form of peaking resource — one that can be located almost anywhere and has low variable costs. Storage can help avoid generation, transmission and distribution **capacity-related costs**. The total costs of storage need to be assigned to the proper time period for equitable treatment of customer classes.

- Consumer-sited resources, including solar and storage, are becoming essential components of the modern **grid**. The **distribution system** may also begin to serve as a gathering system for power flowing from locations of local generation to other parts of the utility service territory, the opposite of the historical top-down electric delivery model.
- **Smart grid** systems make it possible to provide better service at lower cost by including targeted energy efficiency and demand response measures to meet loads at targeted times and places and other measures to take advantage of improved data and operational capabilities. Unfortunately, older techniques, even those resulting from detailed inquiries by cutting-edge regulators in recent decades, may not be sufficiently sophisticated to incorporate new technologies, more granular data and advancements in analytical capabilities. As a result, innovations are needed in the regulatory process to mirror the changes taking place

outside of **public utilities commissions**.

For all cost of service studies, these innovations could include:

- Clear distinction between shared assets and customer-specific assets in the accounting for distribution costs.
- Clearer tracking of distinctions between system costs and overhead investments and expenses at all stages of the rate-making process.
- More accurate definitions of rate classes based on emerging economic and service characteristic distinctions between customers.
- Distinction between loads that can be controlled to draw power primarily at low-cost periods and those that are inflexible.

For embedded cost of service studies, innovative **hourly allocation** techniques could incorporate a number of advances, including:

- Hourly methods for generation: Most generation costs

Figure 4. Modern embedded cost of service study flowchart

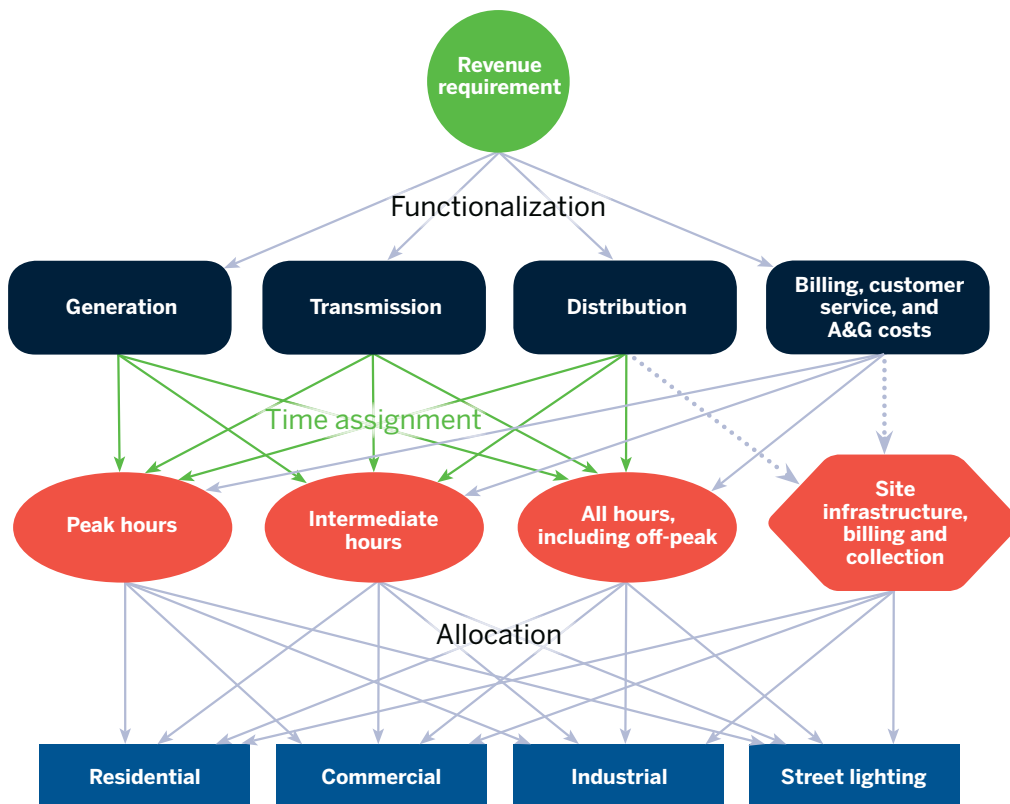

should be assigned to the hours in which the relevant facilities are actually used and to all hours across the year, not solely based on measurements in a subset of these hours.

- Hourly methods for transmission: Transmission costs must be examined to determine the purpose and usage patterns, and costs must be assigned to the hours when the transmission services are utilized to serve customer needs.
- All shared distribution costs should be apportioned based on the time periods when customers utilize these facilities. The system is needed to provide service in every hour, and in most cases a significant portion of the distribution system cost should be assigned volumetrically to all hours across the year.
- Billing, customer service and A&G costs that do not vary based on consumption should be functionalized separately.
- **Site infrastructure** to connect customers, billing and collection should be a separate classification category.

Figure 4 shows an example of a modern time-based allocation method in a reformed flowchart.

Innovation in marginal cost of service studies could take the form of more granular hourly marginal cost analysis for the generation, transmission and shared distribution elements of the system. Alternatively, a more conceptual shift to the **total service long-run incremental cost** method developed for the restructuring of the telecommunications industry should be considered. This method estimates the cost of building a new optimally sized system using current technologies and costs. This avoids a number of significant issues with traditional marginal cost of service studies, particularly the problem of significant swings in estimates based on the presence or absence of excess capacity, but it comes with additional data requirements and new uncertainties.

These proposed innovations, regardless of whether they are adopted widely, shed new light into the foundations of cost allocation and may help the reader gain insight into the underlying questions. More generally, we hope that readers find this manual useful as they undertake the complex task of

apportioning utility costs among functions, customer classes and types of service and that they join us in finding the best path forward.

## Guide to This Manual

After this introduction and summary, this manual is divided into five parts:

- Part I: Chapters 1 through 4 lay out principles of economic regulation of electric utilities, background on the rate-making process, and definitions and descriptions of the electric system in the United States. Readers who are new to rate-making and utility regulation should start here for the basics.<sup>2</sup> Much of this material likely will be familiar to an experienced practitioner but emphasizes key issues relevant to the remainder of the manual.
- Part II: Chapters 5 through 8 cover the important definitions, basic techniques and overarching issues in cost allocation. Some of this material may be familiar to an experienced practitioner but also lays out the issues facing cost allocation.
- Part III: Chapters 9 through 17 delve deeply into the subject of embedded cost of service studies, including discussion of historic techniques, current best practices and key reforms.
- Part IV: Chapters 18 through 26 cover the field of marginal cost of service studies, including historical development, current best practices and key needed reforms.
- Part V: Chapters 27 and 28 cover what happens after the completion of the quantitative studies, including presentation of study results and adjustments, and the relationship between cost allocation and rate design.

The conclusion wraps up with final thoughts.

Each part of this manual ends with a list of works cited. Terms defined in the glossary are set off in boldface type where they first appear in the text.

---

<sup>2</sup> For a more detailed handbook on the structure and operation of the industry, see Lazar, J. (2016). *Electricity Regulation in the United States: A Guide* (2nd ed.). Montpelier, VT: Regulatory Assistance Project. Retrieved from <https://www.raonline.org/knowledge-center/electricity-regulation-in-the-us-a-guide-2/>

### Visual display of cost allocation results

Like much of utility regulation, visual display of information in cost allocation tends to be dry and difficult to understand. Much of the analytical information for cost allocation tends to be displayed in large tables that only experts can interpret. Simple flowcharts, such as Figure 2 on Page 16, are also quite common and convey little substantive information. Nevertheless, it should

be possible to convey cost allocation results in a meaningful way that a wider audience can understand. One possibility is to convert the traditional flowcharts into Sankey diagrams, where the width of the flows is proportional to the magnitude of the costs. Figure 5 shows this type of diagram for a traditional embedded cost of service study.

Figure 5. Sankey diagram for traditional embedded cost of service study

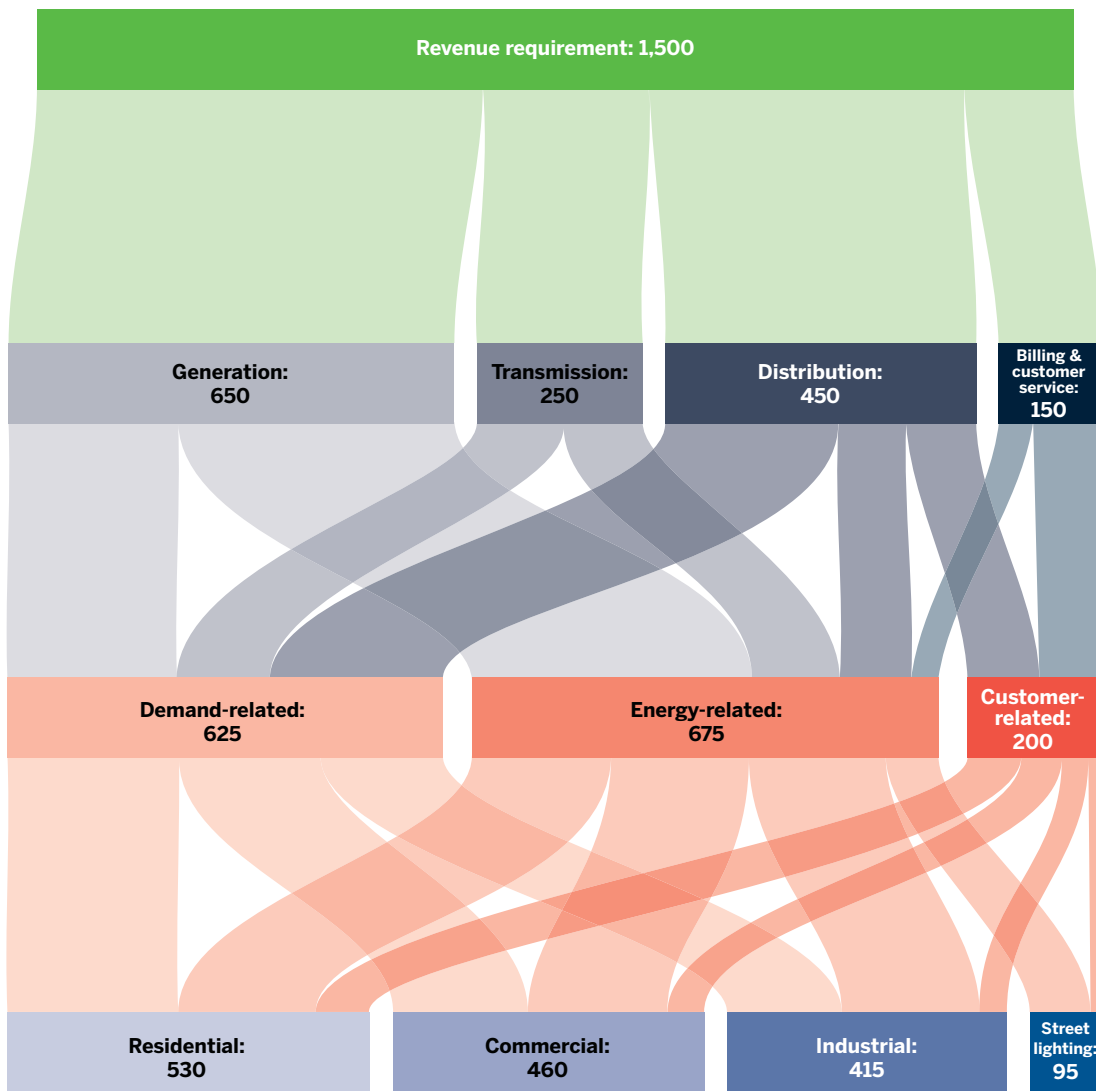

A Sankey diagram can display a tremendous amount of information in a way that is reasonably understandable. At the top, it begins with the overall revenue requirement, then splits into three functions. Next, each function splits into the different classifications, which are then allocated by customer class. At each step, the overall costs stay constant, but the relative sizes for each function, classification and customer class are readily apparent. Additionally, the colors in the diagram can be used to indicate additional distinctions. Figure 6 is a Sankey diagram for

a more complex reformed embedded cost of service study. Like Figure 5, it shows illustrative results that are feasible with certain allocation techniques. In contrast, the flowcharts in figures 2 and 4 show all the different allocation possibilities with arrows linking different categories.

As the Sankey diagram becomes more complex, it can be less intuitive. Yet it is likely a much more understandable visual representation of the key elements of a cost of service study.

**Figure 6. Sankey diagram for modern embedded cost of service study**

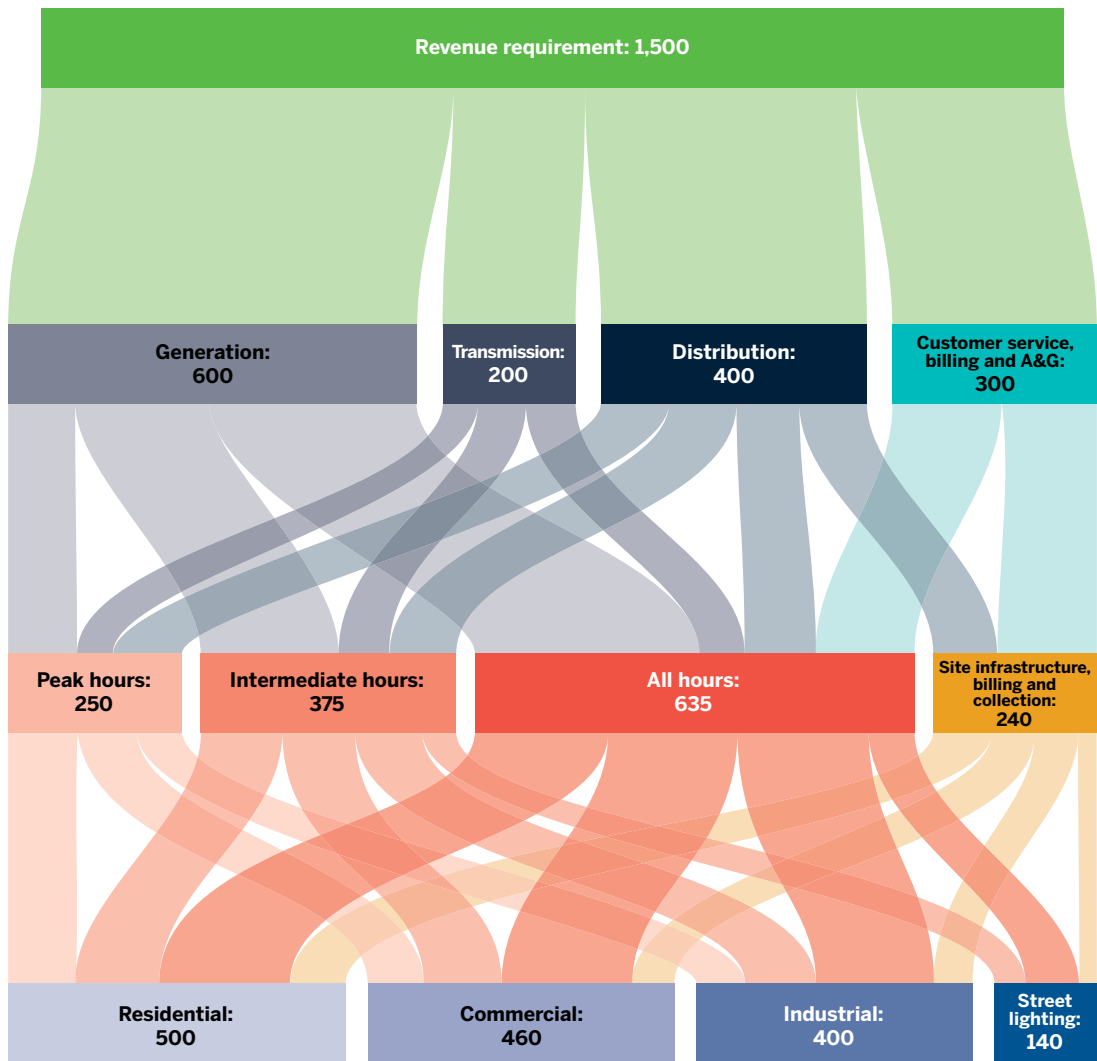

**Part I:**  
**Economic Regulation  
and the Electric System  
in the United States**

# 1. Economic Regulation in the U.S.

**E**conomic regulation of privately owned business dates back to the Roman Empire and was a significant feature of government in medieval England, where accommodation prices at inns were regulated because travelers typically had only a single choice when arriving at the end of a day on foot or horseback. In the later medieval period, the English Parliament regulated bakers, brewers, ferrymen, millers, smiths and other artisans and professionals (Phillips, 1984, p. 77). This tradition was brought to the United States in the 19th century, when a series of Supreme Court opinions held that grain elevators, warehouses and canals were monopoly providers of service “affected with a public interest” and that their rates and terms of service could therefore be regulated.<sup>3</sup>

## 1.1 Purposes of Economic Regulation

The primary purpose of economic regulation has always been to prevent the exercise of monopoly power in the pricing of essential public services. Whether applying to a single inn along a stagecoach route or an electric utility serving millions of people, the essence of regulation is to impose on monopolies the pricing discipline that competition imposes on competitive industries and to ensure that consumers pay only a fair, just and reasonable amount for the services they receive and the commodities they consume. Historically, electric utility service is considered a “natural monopoly” where the cost of providing service is minimized by having a single system serving all users. In recent years, competition has been introduced into the power supply function in some areas. The delivery service remains a natural monopoly in all areas, however, and in much of the U.S., power supply is provided at retail by only a single monopoly utility.

Over time, legislative and regulatory bodies have identified subsidiary purposes of regulation, but these all remain subordinate to this primary purpose of preventing the abuse

Property does become clothed with a public interest when used in a manner to make it of public consequence, and affect the community at large. When, therefore, one devotes his property to a use in which the public has an interest, he, in effect, grants to the public an interest in that use, and must submit to be controlled by the public for the common good ...

— U.S. Supreme Court, *Munn v. Illinois*,  
94 U.S. 113, 126 (1877)

of monopoly power. These subsidiary purposes include:

- Defining and assuring the adequacy of service for customers, including reliability and access to electric service at reasonable prices.
- Setting prices so that the utility has a reasonable opportunity to receive revenue sufficient to cover prudently incurred costs, provide reliable service and allow the utility to access capital.
- Avoiding unnecessary and uneconomic expenditures or protecting customers from the costs of imprudent actions.
- Encouraging or mandating practices deemed important for societal purposes, such as reducing environmental damage and advancing technology.
- Managing intentional shifts in cost responsibility from one customer group to another, such as economic development discounts for industrial customers or assistance for low-income and vulnerable customers.

When monopoly power ceases to be a concern, as when there are many buyers and sellers in a transparent market, the basis for imposing price regulation evaporates. Transportation and telecommunications services used to be regulated in the United States, but as technology changed in a way that

<sup>3</sup> *Munn v. Illinois*, 94 U.S. 113 (1877). The term “affected with a public interest” originated in England around 1670, in two treatises by Sir Matthew Hale, Lord Chief Justice of the King’s Bench, *De Portibus Maris* and *De Jure Maris*. *Munn v. Illinois*, at 126-128.

allowed competition, policymakers eliminated the economic regulation, or at least changed the essential features of the regulatory structure. A similar phenomenon has occurred with the introduction of wholesale markets for electricity generation in many parts of the country.

James Bonbright, regarded as the dean of utility rate analysts, set out eight principles that are routinely cited today.

## 1.2 Basic Features of Economic Regulation

To prevent the exercise of monopoly power, the primary regulatory tool used by governments has been control over the prices the regulated company charges. During the decline of the Roman Empire, emperors issued price edicts for more than 800 articles based on the cost of production (Phillips, 1984, p. 75). Utility regulators today review proposals for rates from utilities and issue orders to determine a just and reasonable rate, typically based on the cost of service. However, price regulation raises the question of the quality and features of the product or service. Inevitably, this means that price regulation must logically extend to other features of the product or service. In the case of electricity, this means utility regulators typically have regulatory authority over the terms of service and often set standards for reliability to ensure a high-quality product for ratepayers.

In the regulation of prices for utility service, the prevailing practice, known as **postage stamp pricing**, is to develop separate sets of prices for a relatively small and easily identifiable number of classes of customers. For electric utilities, one typical class of customers is residential.

We are asking much of regulation when we ask that it follow the guide of competition. As Americans, we have set up a system that indicates we have little faith in economic planning by the government. Yet, we are asking our regulators to exercise the judgment of thousands of consumers in the evaluation of our efficiency, service and technical progress so that a fair profit can be determined. Fair regulation is now, and always will be, a difficult process. But it is not impossible.

— Ralph M. Besse, American Bar Association annual meeting, August 25, 1953 (Phillips, 1984, p. 151)

For a given utility and its service territory, all customers in this class pay the exact same prices. Postage stamp pricing clearly deviates from strict cost-based pricing but addresses a number of regulatory needs. It keeps the process relatively simple by limiting the number of outputs that need to be produced to one set of rates for each broad customer class. Since rates need to be tied to the cost of service, this logically implies that the cost of service must be determined separately for each rate class, which is one of the key outputs of the cost allocation phase of a **rate case**.

Postage stamp pricing also puts an end to one of the unfair pricing strategies monopolies undertake, known as price discrimination. Price discrimination — that is, strategically charging some customers more than others — helps a monopolist maximize profits but also serves as a way for an unregulated monopolist to punish some customers and reward others. Of course, different pricing can be appropriate for customers that incur different costs.

## 1.3 Important Treatises on Utility Regulation and Cost Allocation

This handbook recognizes the pathbreaking work done by cost and rate analysts in the past. It is important to review these foundational works, recognize the wisdom that is still current and identify how circumstances have changed to where some of their theories, methodologies and recommendations are no longer current with the industry.

James Bonbright is regarded as the dean of utility rate analysts. His book *Principles of Public Utility Rates*, first published in 1961, addresses all of the elements of the regulatory process as it then stood, with detailed attention to cost allocation and rate design. Bonbright set out eight principles that are routinely cited today (1961, p. 291):

- i. The related, “practical” attributes of simplicity, understandability, public acceptability, and feasibility of application.



2. Freedom from controversies as to proper interpretation.
  3. Effectiveness in yielding total revenue requirements under the fair-return standard.
  4. Revenue stability from year to year.
  5. Stability of the rates themselves, with a minimum of unexpected changes seriously adverse to existing customers. ...
  6. Fairness of the specific rates in the apportionment of total costs of service among the different consumers.
  7. Avoidance of “undue discrimination” in rate relationships.
  8. Efficiency of the rate classes and rate blocks in discouraging wasteful use of service while promoting all justified types and amounts of use.
3. Customers with continuous demand should get a bigger share of capacity costs than those with intermittent demand, because the intermittent demand customers have diversity and can share capacity.
  4. No class gets a free ride. Every class, including fully **interruptible customers**, must contribute something to the overall system costs in addition to the variable costs directly attributable to its usage.

Of these, principles 6 and 7 are the most closely related to cost allocation.

Bonbright’s chapters on marginal costs (Chapter 17) and fully distributed costs (Chapter 18) are most relevant to this manual’s purpose. His analysis of marginal costs carefully distinguishes between **short-run marginal costs** (in which capital assets are not changeable) and long-run marginal costs (in which all costs are variable) and discusses which are most applicable for both cost allocation and rate design. A second edition of this book, edited by Albert Danielsen and David Kamerschen, was published posthumously in 1988.

Paul Garfield and Wallace Lovejoy published their book *Public Utility Economics* in 1964. This text focuses on the economic structure of the industry and the need to have costs and rates measured in terms that elicit rational response by consumers. This text also provides an excellent set of principles for cost allocation and rate design with respect to the shared capacity elements of costs:<sup>4</sup>

1. All service should bear a portion of capacity costs.
2. Capacity charges attributed to each user should reflect the amount of time used, peak characteristics, interruptible characteristics and diversity.

Alfred Kahn first published *The Economics of Regulation* in two volumes in 1970 and 1971, and a second edition was issued in 1988. Kahn raised the innovative notion of using marginal costs, rather than **embedded costs**, as a foundation of rate-making generally and cost allocation and rate design more specifically. Some states use this approach today. Kahn also served as a regulator, as the chair of both the New York Public Service Commission and the federal Civil Aeronautics Board, which oversaw the deregulation of airlines.

Charles Phillips published *The Regulation of Public Utilities* in 1984, and subsequent editions were released in 1988 and 1993. Phillips wrote in the post-PURPA era, at a time when utility construction of major baseload generating units was winding down. He addressed the desirability of recognizing the difference between baseload and peaking investments as well as the evolution of these cost differentiations into **time-varying rates**. Up to that time, few attempts had been made to prepare time-varying embedded cost studies.

The National Association of Regulatory Utility Commissioners published its *Electric Utility Cost Allocation Manual* in 1992. That handbook provided explicit guidance on some of the different methods that regulators used at that time to apportion rates for both embedded cost and marginal cost frameworks. It was controversial from the outset, due to omission of a very common method of apportioning distribution costs — the basic customer method. However, it is the most recent, comprehensive and directly relevant work on cost allocation prior to this manual.

4 Simplified from principles attributed to Henry Herz, consulting economist, cited in Garfield and Lovejoy (1964, pp. 163-164).

## 2. Main Elements of Rate-Making

The process of setting rates varies significantly among states and different types of utilities, such as investor-owned utilities regulated by state utility commissions and self-regulated **municipal** and **cooperative utilities**. However, the most basic and essential elements are typically the same. The discussion in this chapter focuses on the methods used for IOUs, with occasional notes on distinctions in other contexts.

There are three distinct elements, or phases, in a rate case, and each phase feeds into the next. The first determines the required level of annual revenue, typically known as the revenue requirement. The second phase, the primary subject of this manual, apportions the revenue requirement among a small number of customer classes, traditionally with additional distinctions made between customer-related costs, demand-related costs and energy-related costs. Finally, the individual prices, formally known as **tariffs** or rates,<sup>5</sup> are designed in order to collect the assigned level of revenue from each class. These elements can be considered by the regulator at the same time or broken into separate proceedings or time schedules. Regardless, the analysis is inevitably sequential. This chapter ends with a brief description of the key features of the procedure used in rate cases.

### 2.1 Determining the Revenue Requirement

The revenue requirement phase of a conventional rate case consists of determining the allowed **rate base**, allowed **rate of return** and allowed operating expenses for the regulated utility on an annualized basis. In most jurisdictions, the annualized revenue requirement is developed for a “**test year**,” which is defined as either a recent year with actual data, which may be adjusted for known changes, or

projections for a future year, often the period immediately after the expected conclusion of the rate case. A few elements of the revenue requirement phase have important bearing on the cost allocation study, and we address only these.<sup>6</sup>

Many regulated utilities in the modern United States are one corporation within a broader holding company, which may include other regulated utilities or other types of corporate entities. Early in the revenue requirement process, the utility must identify the subset of costs relevant to the regulated operations that are the subject of a rate case and separate those costs from other operations and entities. This is generally called a jurisdictional allocation study. It is likely that a holding company that has both regulated and unregulated activities has some activities that are of a fundamentally different nature and level of risk from the operations of the regulated utility in question, where sales and revenues can be relatively stable. Jurisdictional allocation is generally beyond the scope of this manual, but many of the principles for apportioning costs among classes may also be relevant for apportioning those costs among multiple states served by a single utility or utility holding company.

Within the subset of costs identified by the regulated utility, the regulator has the discretion to disallow certain costs as imprudent or change key parameters used by the utility to determine the overall revenue requirement. Disallowance of major costs, such as investments in power plants that were not completed or did not perform as expected, have occurred and have led to the bankruptcy of a utility in at least one case.<sup>7</sup> Smaller disallowances or adjustments are more common, such as a reduction in the allowed rate of return the utility proposes, as well as common disallowances for advertising and executive or incentive compensation, which would lower the revenue requirement commensurately.

<sup>5</sup> This is an important difference between British English, where “rates” refers to property taxes, and American English, where the term means retail prices.

<sup>6</sup> For a more detailed discussion of the determination of the revenue requirement, see Chapter 8 of Lazar (2016).

<sup>7</sup> This was the Public Service Company of New Hampshire and the Seabrook nuclear plant (Daniels, 1988).

**Performance-based regulation** (PBR) may divert from the strict cost accounting approach of the conventional rate case, relying on the performance of the utility to meet goals set by the regulator as a determinant of all or a portion of the revenue requirement.<sup>8</sup>

At the end of this phase, the regulated utility has been assigned a certain level of revenue that it is expected to be able to collect in the **rate year** following the end of the rate case. This annualized revenue requirement is passed along to the next step in the process.

## 2.2 Cost Allocation

In the second phase of a rate case, the overall revenue requirement is divided up among categories of utility customers, known as classes. These customer classes are usually quite broad and can contain significant variation but are intended to capture cost differentials among different types of customers. Some utilities have many customer classes, but typical classes for each utility include residential customers, small business customers, large commercial and industrial (C&I) customers, irrigation and pumping, and street lighting customers.

At this stage in the process, the utility will use different types of data it has collected to assign costs to each customer class. The types of data available have changed over time, but historically these have included energy usage in specific time periods, different measures of demand, the number of customers in each class and information on generation patterns. In addition, utility costs are categorized using a tracking system known as the Uniform System of Accounts. This system was established by the Federal Power Commission — now the **Federal Energy Regulatory Commission** (FERC) — around 1960, leading to the shorthand of “FERC accounts.” Further detail is provided in Appendix A.

These data will be used in a cost of service study that attempts to equitably divide up the revenue requirement among the rate classes. There are two major categories in these studies: an embedded cost of service study (or fully allocated cost of service study), which focuses on the costs the utility intends to recover and other metrics for one year; and a marginal cost of service study, which estimates the

responsibility of customer classes for system costs in the future.

An embedded cost of service study itself typically has three major steps:

1. Functionalization of costs as relevant to generation, transmission, distribution and other categories, such as billing and customer service and administrative and general costs.
2. Classification of costs as customer-related, demand-related or energy-related.
3. Allocation among rate classes.

An embedded cost of service study directly splits up the revenue requirement, which is itself calculated on an embedded cost basis.

A marginal cost of service study has a different structure. It begins with a similar functionalization of costs, separately analyzing generation, transmission and distribution. The next step is the estimation of marginal unit costs for different elements of the electric system and customer billing. The estimated marginal costs are then multiplied by the billing determinants for each class. This produces a class marginal cost revenue requirement; when combined with other classes, it’s a system MCRR. However, revenue determination solely on this marginal cost basis typically will be greater or less than the allowed revenue requirement, which is normally computed on an embedded cost basis. It is only happenstance if the MCRR is the same as, or even similar to, the revenue requirement calculated on an embedded cost basis. As a consequence, the results of a marginal cost of service study must be reconciled to recover the annual revenue requirement.

Although both embedded and marginal cost studies include precise calculations, most regulators are not strictly bound by the results. Numerous other factors are involved in cost allocation for each rate case, including gradualism of rate changes, policy considerations, such as anticipated changes, and economic conditions in the service territory. The data developed for cost allocation and the analytical techniques used in the cost of service studies can provide helpful information for other purposes, such as rate design. Careful attention

---

<sup>8</sup> For an example of a framework that divorces utility earnings from utility investment, see Lazar (2014). For a broader discussion of performance-based regulation, see Littell et al. (2017).

must be paid, however, to the reason the data were developed, and caution must be taken so that this information is used constructively in an appropriate manner.

The final allocation of costs among the rate classes, as well as the other relevant data and analysis, is passed on to the next step in the process.

## 2.3 Rate Design

The rate design phase of a proceeding is sometimes separated in time from the previous phases so the parties know the revenue amounts that each class is expected to contribute, or it may be combined into a single proceeding with the other two phases. This manual does not address rate design principles in detail, but they are addressed in two companion publications by RAP: *Smart Rate Design for a Smart Future* (Lazar and Gonzalez, 2015) and *Smart Non-Residential Rate Design* (Linville, Lazar, Dupuy, Shipley and Brutkoski, 2017). Related issues around compensation for customers with distributed generation are also addressed in RAP's *Designing Distributed Generation Tariffs Well* (Linville, Shenot and Lazar, 2013).

At the highest level, the principles used for rate design are significantly different from those for cost allocation. Rate design should always focus on forward-looking efficiency, including concepts like long-run marginal costs for the energy system and societal impacts more generally, because rate design will influence consumer behavior, which in turn will influence future costs.

Rate design decisions also include principles around understandability and the ability of customers to manage their bills and respond to the price signals in rates. Of course, equity is also a consideration in the rate design process, but in a significantly different context: Primarily, it's concerned with the distribution of costs among individual customers within a rate class.

There are three basic rate components:

1. **Customer charges:** fees charged every billing period

that generally do not vary with respect to any usage characteristics.

2. **Volumetric energy charges:** prices based on metrics of kWh usage during the billing period.
3. **Demand charges:** prices based on metrics of kW or **kilo-volt-ampere** (kVA) power draw during the billing period.

These three basic options allow for a wide range of variations based on season, time of day and type of demand measurement. All types of rates can vary from season to season or month to month, often based on either the cost of service study or energy market conditions.<sup>9</sup> Both demand charges and **energy charges** measure the same thing: electricity consumption over a period of time. Even though demand charges are typically denominated in kW as a measurement of power draw, virtually all demand charges are actually imposed on consumption within short windows, often the highest 15-, 30- or 60-minute window during the billing period.<sup>10</sup> Because it is based on the maximum within those short windows, a demand charge effectively acts as a one-way ratchet within a billing period. Additional ratchets can be imposed over the course of the year, where the demand charge may be based on the greater of either billing period demand or 90% of the maximum demand within the previous year. In contrast, energy charges are based on consumption throughout a billing period, with no ratchets. Energy charges can vary by time within a billing period, generically known as time-varying rates.<sup>11</sup> Common variants include **time-of-use** (TOU) energy charges, where prices are set separately for a few predetermined time windows within each billing period; and **critical peak pricing**, where significantly higher prices are offered for a short time period announced a day or two in advance in order to maximize customer response to events that stress the system.

Some rate analysts propose rates that rigorously follow the results of a cost allocation study, meaning that customer-related costs must be recovered through customer charges and demand-related costs must be recovered through

<sup>9</sup> Rates that vary by season are often referred to as seasonal rates. However, some utilities also define "seasonal" customer classes for customers who have a disproportionate share of their usage during a particular time period. Rates for seasonal customer classes may also be referred to as seasonal rates, which can cause confusion.

<sup>10</sup> Note that in these cases kW is a simplified description of kWhs per hour since it is not truly an instantaneous measurement.

<sup>11</sup> Some analysts may describe certain types of demand charges as time-varying rates as well, such as those that are imposed only within certain time windows (e.g., 2 to 6 p.m. on nonholiday weekdays).

demand charges. However, most analysts do not and are careful to note that categorizations like “demand-related” are simplifications at best and, as this manual details, generally reflect an increasingly obsolete framework. Forward-looking efficiency is not a feature of embedded cost of service studies and additionally may require consideration of broader **externalities** that are not necessarily incorporated in the revenue requirement. Similarly, rate design must consider customer bill impacts and the related principles of understandability, acceptability and customer bill management.

## 2.4 Rate Case Procedure

Although procedures at state utility commissions vary greatly, there are typically several common elements. Most rate cases begin with a proposal from the regulated utility. In the most formal terms, a utility commission is adjudicating the rights, privileges and responsibilities of the regulated utility, although typically without the full formalities and rules of a judicial proceeding. Other interested parties are allowed to become intervenors to participate in discovery, present witnesses, brief the issues for the commission and potentially litigate the result in court. This process often

automatically includes an official state consumer advocate. A wide range of stakeholders may join the process, including large industrial consumers, chambers of commerce, low-income advocates, labor, utility investors, energy industries and environmental advocates. These non-utility parties can critique the utility proposal and can propose alternatives to utility cost allocation methods as well as other substantive elements of the rate case. Rate cases can be resolved through a final decision by the utility commission based on the record presented, or some or all aspects of a rate case can be resolved through a settlement among the various parties.

The costs of a rate case for the regulated utility are considered part of the cost of service and ultimately become part of the revenue requirement determined in the rate case. Many states make explicit funding arrangements for the commission itself and any state consumer advocate, often ultimately recovered from ratepayers. In some states and most Canadian provinces, ratepayer funding was historically given to other intervenors who participated productively in the process, a practice that continues in California. However, it is much more common for stakeholders to bear the burden of any litigation costs, which limits the ability of many stakeholders to advance their interests at this level.

## 3. Basic Components of the Electric System

The electric utility system, for general descriptive purposes and for regulatory and legal purposes, typically is divided into several categories of activities and costs, including generation, transmission, distribution, billing and customer service, and A&G costs. In a vertically integrated utility, a single entity owns and operates all of these, although many other forms of market structure and ownership exist in the United States. Each of these segments includes capital investments and labor and nonlabor operating expenses. Each of these segments is operated and regulated according to different needs and principles.

These distinctions at each level of the power system are important to cost allocation, and the terminology is important to understand. Many of the arguments about proper allocation of costs hinge on the purpose for, and capabilities of, capital investments and the nature of operating expenses. Thus, having a correct understanding of the purpose, limitations and current usage of each major element of the system is important to resolve key cost allocation questions. Figure 7 is a diagram of a traditional electric power system, with one-way power flow from a large central generation facility through the

transmission and distribution system to end-use customers (U.S.-Canada Power System Outage Task Force, 2004).

The evolving electric grid will be much different from the grid of the past hundred years. The “smart grid” of the future will look different, operate differently and have different cost centers and potentially different sources of revenues. As a result, it will need different cost allocation methods. Figure 8 on the next page shows a vision of the direction the electric system is evolving, with generation and storage at consumer sites, two-directional power flows, and more sophisticated control equipment for customers and the grid itself (U.S. Department of Energy, 2015).

This manual discusses many of the changes underway in the electric system, but undoubtedly the future will bring further change and new challenges.

### 3.1 Categories of Costs

All decisions that a utility makes have consequences for its overall cost of service. Some of those decisions were made decades ago, as the utility made investments — including large power plants and office buildings — based on conditions

Figure 7. Illustrative traditional electric system

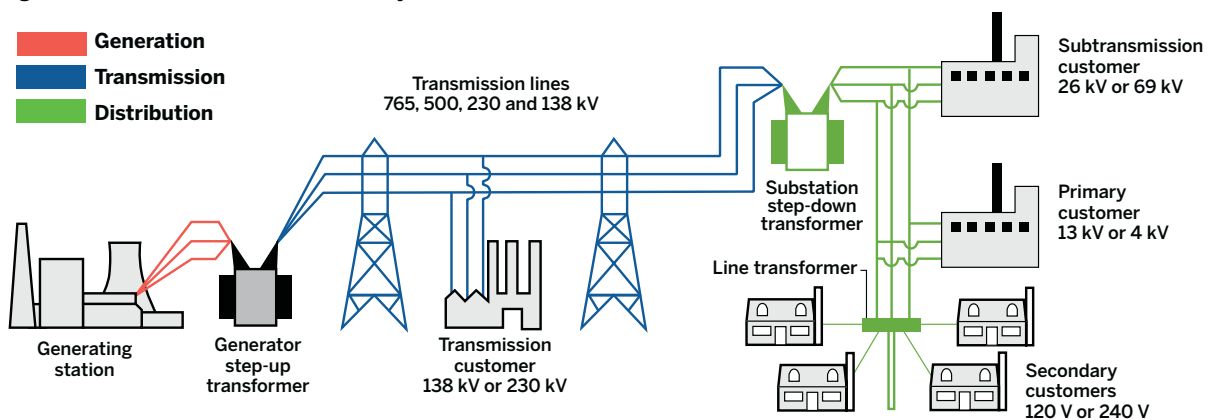

Source: Adapted from U.S.-Canada Power System Outage Task Force. (2004). *Final Report on the August 14, 2003 Blackout in the United States and Canada: Causes and Recommendations*

Figure 8. Illustrative modern electric system

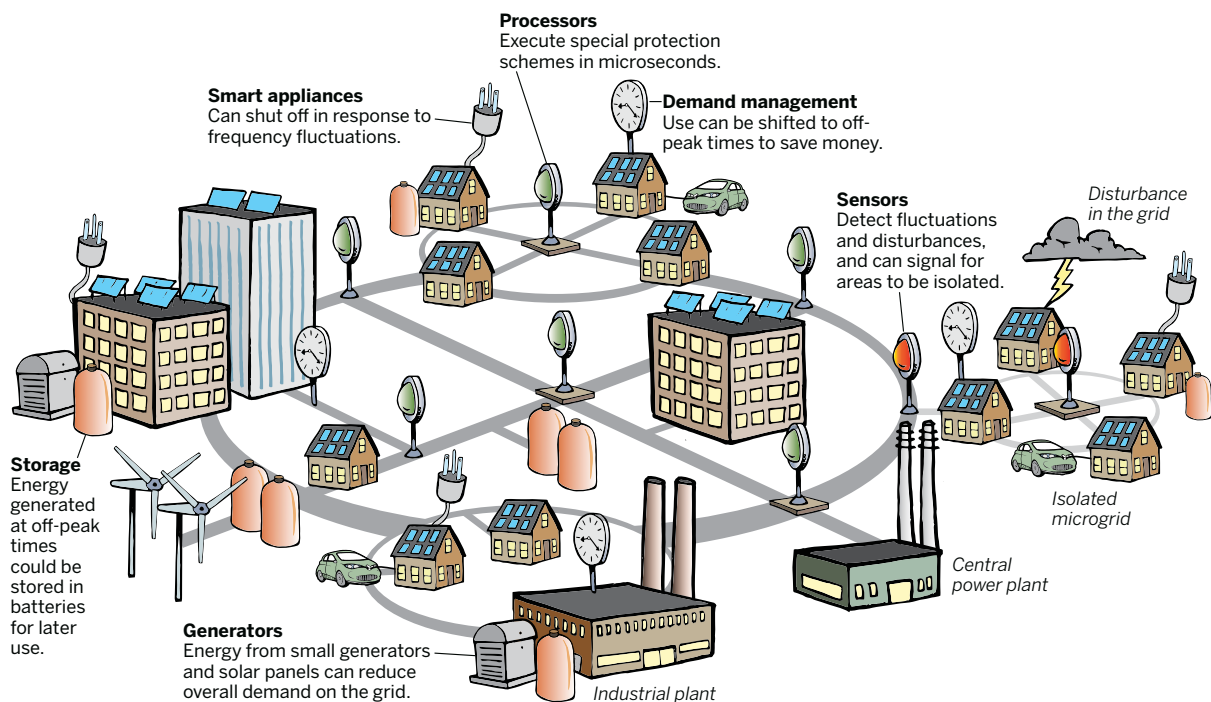

Source: Adapted from U.S. Department of Energy. (2015). *United States Electricity Industry Primer*

or forecasts at that time. Some of the decisions are made every day, as the utility dispatches power plants or replaces worn-out distribution equipment. Many of the decisions that determine the utility's revenue requirement — such as the historical decisions to build particular power plants in particular locations — result from complex processes involving past expectations and many practical complications and trade-offs.

### 3.1.1 Generation

Electricity generation<sup>12</sup> comes from many different types of technologies that utilize many different types of fuels and resources. Most types of steam-electric units burn fuel, which can be oil, coal, natural gas, biomass or waste products, in a boiler to produce steam to turn a turbine. This turbine then turns an electric generator. Most steam units are older and generally limited in their ability to cycle on and off. This means they can only change generation levels slowly and may require many hours to start up, shut down and restart.

Some noncombustion technologies use a steam turbine to generate electricity. Some geothermal units use steam to drive a turbine, using heat transferred up from underground to boil water. Concentrated solar power, or solar thermal, uses heat from the sun to boil water and spin a turbine. Nuclear generation also uses a steam turbine, where the heat to boil water comes from a chain reaction of uranium fission.

Combustion turbines, which are similar to jet engines, use heated gases from the combustion of either a liquid or gaseous fuel to directly spin a turbine and generate electricity. Simple cycle combustion turbines directly exhaust a significant amount of heat. Combustion turbines can be turned on and off very quickly and require high-quality, relatively clean fuels because of the contact between the combustion gas and the turbine blades.

<sup>12</sup> Some sources, including the FERC accounts and the 1992 NARUC *Electric Utility Cost Allocation Manual*, use the term "production" instead of "generation." This manual uses the term "generation" and generally includes exports from storage facilities under this category.

**Combined cycle units** include combustion turbines but capture the waste heat to boil water, produce steam and spin an extra turbine to generate electricity. As a result, combined cycle units have higher capital costs than combustion turbines but generate more electricity for each unit of fuel burned.

Hydroelectric plants use moving water, either released from reservoirs or running in rivers, to spin turbines and generate electricity. These units vary widely in their seasonal generation patterns, storage capacity and dispatchability. Many, but not all, hydroelectric plants are easily dispatchable to follow load but may be constrained by minimum and maximum allowed river flows below the facility.

There are also a variety of noncombustion renewable resources, including wind power, solar photovoltaic (PV), solar thermal and potentially tidal and current power. In addition, fuel cells can generate electricity from hydrogen by using a chemical reaction. The only byproduct of a fuel cell reaction is water, but different methods of producing hydrogen can have different costs and environmental impacts.

Power supply can come from different types of energy storage facilities as well, although most of these resources also consume electricity. Traditional types of storage, such as pumped hydroelectric storage (where water is moved to higher ground using electricity at times of low prices and released back down to spin turbines at times of high prices) and flywheels have been around for many decades, but battery storage and other new technologies are becoming more prevalent. Different types of storage technologies can have very different capabilities, varying from a few minutes' worth of potentially exportable energy to a few months' worth, which determines the types of system needs that the storage can address. As a result, the allocation of these costs requires careful attention by the cost analyst.

Each of these technologies has a different cost structure, which can depend on the type of fuel used. This is typically divided among: (1) upfront investment costs, also known as capital costs; (2) **operations and maintenance (O&M) costs**, which may depend on the numbers of hours a facility generates ("dispatch O&M costs") or can be incurred regularly on a monthly or annual basis ("nondispatch O&M costs"); and

(3) fuel costs. Fuel costs per unit of energy generation depend on the price of the fuel consumed and the efficiency of the unit; this is often defined as an efficiency percentage comparing input fuel potential energy to output electric energy, or as a **heat rate** defined as the **British thermal units (Btu)** of fuel input for every kWh of output electric energy.

Dirtier fuels, such as coal and oil, require expensive and capital-intensive pollution control equipment. Different costs are also incurred in the delivery and handling of each fuel prior to its use, as well as the disposal of any byproducts. For example, both coal ash and nuclear waste require disposal, and there are different controversies and costs associated with each. Noncombustion renewable resources have very low variable costs and relatively high capital costs. Storage resources generally have high investment costs, moderate maintenance costs and low operating costs. The decision around their dispatch is defined by the opportunity cost of choosing the hours to store and discharge, with the goal of picking the hours with the greatest economic benefit.

Some plants, mainly steam, combustion turbine and combined cycle, can be set up to use more than one fuel, primarily either natural gas or oil. Such a dual fuel setup involves a range of costs but allows the plant operator to choose the fuel that is less expensive or respond to other constraints.

Generation facilities are frequently categorized by their intended purpose and other characteristics. This terminology is evolving and does not necessarily reflect a permanent condition. For example, several types of units traditionally have been characterized as baseload because they are intended to run nearly all the time. This includes most steam-electric combustion units, particularly those run on coal. This also includes nuclear units, which run nearly all of the time with the exception of long refueling periods every few years that can last for months. Historically, **baseload units** had higher capital costs, which could be offset by lower fuel costs given their ability to run constantly. However, as fuel price patterns have changed, this is not always the case, particularly when natural gas is cheaper than coal.

Several types of plants are characterized as **peakers** or peaking units because they are flexible and dispatched easily at times of peak demand. Combustion turbines are the prime



example of a peaking unit. Historically, these units had lower capital costs per unit of capacity and higher fuel costs per kWh generated. Again, this may no longer be true as fuel prices have changed.

Plants that are neither baseload nor peaking units are often referred to as **intermediate units**. They run a substantial portion of the year but not the whole year or just peak hours. “Midmerit” and “cycling” are commonly used synonyms for these types of generators. Over the last two decades, natural gas combined cycle facilities often filled this role in many parts of the country, but changing fuel costs and environmental regulations have altered the typical operating roles of many types of generation.

Hydroelectric units may effectively be baseload resources or may be storage reservoirs that allow generation to be concentrated in high-value hours. Other noncombustion renewable resources are often characterized as variable or **intermittent resources** because these technologies can generate electricity only in the right conditions — when the sun is shining, the wind is blowing or the currents are moving. However, the addition of storage to these facilities can make these characteristics much less relevant. In addition, the accuracy of forecasts for these resources has improved greatly. These variable renewable resources can also be operated in certain ways to respond to electric system or market conditions, such as through **curtailment**.

### 3.1.2 Transmission

**Transmission systems** comprise high-voltage lines, over 100 **kilovolts (kV)**, that are generally carried via large towers (although sometimes on poles or buried underground) and the **substations** that interconnect the transmission lines both to one another and between generation resources and customers. Subtransmission lines that interconnect distribution substations, operating between 50 kV and 100 kV, may be functionalized as distribution plant.

Utilities use a variety of transmission voltages. A higher voltage allows more power to be delivered through the same size wires without excessive **losses**, overheating of the **conductor** (wire) or excessive drop in the operating voltage over the length of the line. Higher voltages require taller towers to

separate the power lines from the ground and other objects and better insulation on underground cables but are usually less expensive than running multiple conductors at lower voltages where large amounts of power need to be delivered.

Transmission systems can also be either **alternating current (AC)** or **direct current (DC)**. Some transmission using DC has been built because it can operate at high voltages over longer distances with lower losses; these lines are known as **high-voltage direct current (HVDC)**. However, the vast bulk of the transmission system in the United States is AC.

Transmission serves many overlapping functions, including:

- Connecting inherently remote generation (large hydro, nuclear, mine-mouth coal, wind farms, imports) to load centers.
- Allowing power from a wide range of generators to reach any distribution substation to permit least-cost economic dispatch to reduce fuel costs.
- Providing access to neighboring utilities for **reserve sharing**, economic purchases and economic sales.
- Allowing generation in one area to provide backup in other areas.
- Reducing **energy losses** between generation sources and the distribution system, where transmission capacity is above the minimum required for service.

Each of these purposes carries different implications for cost allocation. Some transmission is needed in all hours, while other transmission is built primarily to meet peak requirements.

Transmission substations connect the generators to the transmission system and the various transmission voltages to one another. They also house equipment for switching and controlling transmission lines. Most substations are centered on large **transformers** to convert power from one voltage to another. The largest customers, such as oil refineries, often have their own substation and take delivery from the grid at transmission voltage.

### 3.1.3 Distribution

Distribution substations and lines are required for the vast majority of customers who take service at the

distribution level. The distribution system receives power primarily from the transmission system through distribution substations, which convert power from higher transmission-level voltages down to distribution-level voltages. Some power may be delivered to the distribution system directly from small generators, such as small hydro plants and distributed generation. Distribution substations are smaller versions of transmission substations.<sup>13</sup> These are often connected by subtransmission lines, which may be functionalized as either transmission or distribution in cost studies. Collectively, the transmission and distribution systems are referred to as T&D or as the delivery system.

From each substation, one or more distribution feeders operating between 2 kV and 34 kV, known as **primary voltage** lines, run as far as a few miles, typically along roadways. These are mostly on wooden utility poles shared with telephone and cable services or in underground conduit. A single pole or underground route may carry multiple circuits. Each feeder may branch off to serve customers on side streets. Although distribution feeders leaving the substations are usually three-phase, like the transmission lines, branches that do not carry much load may be built as single-phase lines with just two wires.

Some customers take power directly at primary voltage (usually 2 kV to 34 kV) and transform it down within their premises to a **secondary voltage** (600 volts or less) or use it directly in high-voltage equipment. All residential and most commercial customers take service at secondary voltages, which typically range from 120 V to 480 V. For that purpose, the utility must provide **line transformers**, which are the large cylinders on some utility poles for overhead distribution and the ground-mounted metal boxes near buildings for underground distribution. There is a frequently used shorthand in which customers served at primary voltage are referred to as primary customers and any customer classes distinguished on this basis are described as primary — for example, primary **general service** or primary commercial. Similarly, customers served at secondary voltage can be described as secondary customers, and customer classes distinguished on that basis are referred to as secondary — for example, secondary general service or secondary commercial.

In urban and suburban settings, a typical transformer will serve several residential customers or small businesses, either in one building or several buildings that are relatively close to one another. Typically, an apartment building is served by a larger transformer than would serve single-family dwellings, but the transformer or multitransformer installation could serve dozens or even hundreds of customers. A single large secondary customer is usually served by one or more dedicated transformers, and in exurban and rural areas even a relatively small customer may be so far away from neighbors as to require a dedicated transformer.

Some secondary voltage customers will be served directly by a **service line** from the transformer to their buildings. Other customers farther up the road will be fed from a secondary distribution line from a nearby transformer that is attached to the same poles as the primary feeder but lower down. Secondary voltage lines in older neighborhoods served with overhead wires are often networked among several transformers. For many utilities, underground secondary lines in modern neighborhoods generally are not networked. Underground service is generally more expensive than overhead service but often required by local regulations for aesthetics or reliability reasons.

Figure 9 on the next page illustrates one relatively common arrangement. In this example, each transformer serves two houses directly with service lines, and feeds secondary lines from which service lines run to two or three other houses on the same side of the street and four or five houses across the street. The illustration is for an underground system. The basic layout of an overhead system would be similar. However, since it is easier to string overhead service lines across the street than to dig lines under the street, service lines might run directly from an overhead transformer to one or two houses across the street, and the secondary might just run on the transformers' side of the street, with service lines crossing the street to additional customers. The key factor here for cost allocation purposes is that even secondary voltage lines are often shared among multiple customers and are not a direct cost responsibility of any one of them individually.

---

<sup>13</sup> In some cases, a higher-voltage distribution line (e.g., 13 kV) may power a lower-voltage line (e.g., 4 kV) through a substation.

Figure 9. Underground distribution circuit with radial secondary lines

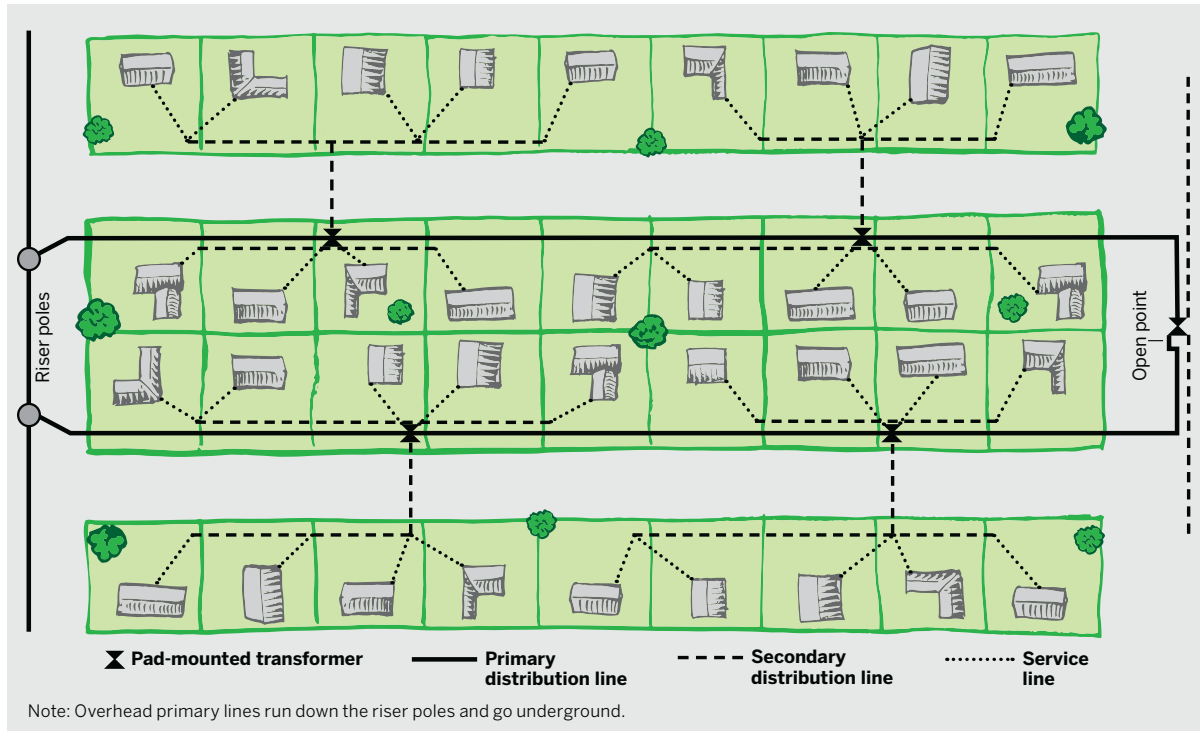

Figure 10 shows a portion of a similar distribution circuit but highlights the difference that in this case the secondary lines are networked, meaning power can flow to the relevant customers over both transformers simultaneously. This allows each transformer to serve as backup for the others in that network and allows for more flexible operation to minimize losses and prevent overloads.

Figure 10. Detail of underground distribution circuit with networked secondary lines

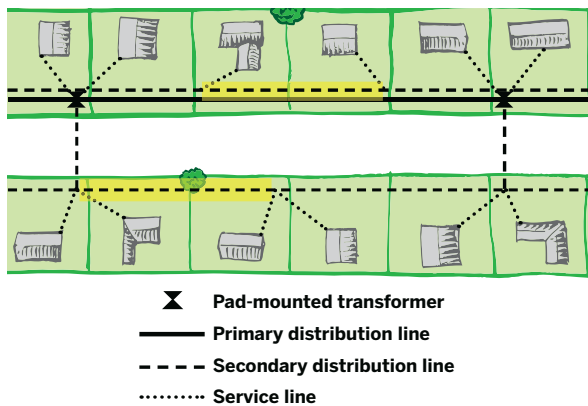

Figure 11 on the next page illustrates a typical overhead distribution pole, showing the primary lines, a transformer, an electric service to one home and secondary lines running in both directions to serve multiple homes.

The final step in the delivery of power from the utility to the customer is the service line, or drop,<sup>14</sup> from the common distribution facilities in the public right of way to the customer’s meter. That line may be overhead or underground. Even where the distribution service is overhead, customers may be served by an underground service drop out of concerns for aesthetics or reliability, since underground lines are not vulnerable to damage from wind or trees.

For primary voltage customers, the service drop is a line at the primary voltage, attached to one or more phases of primary feeder. For secondary customers, the service drop may run from the transformer to the customer or from a convenient point along the secondary lines.

<sup>14</sup> Since overhead service lines often slope down from their connection on the utility pole to the attachment point on the customer’s building, they tend to literally “drop” the service down to the customer.

Figure 11. Secondary distribution pole layout

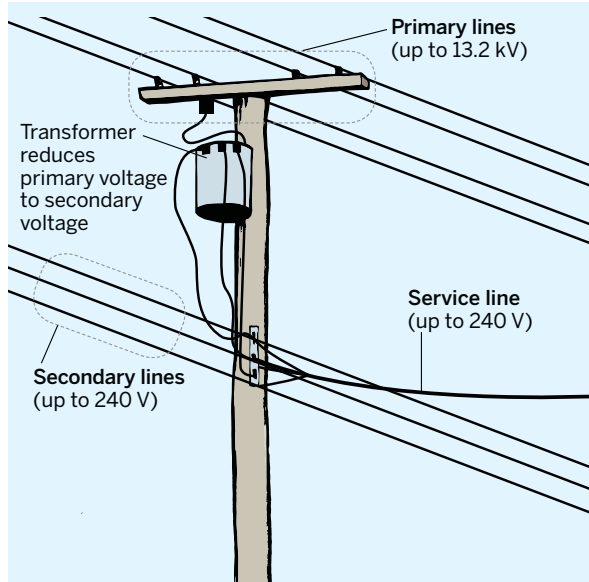

### 3.1.4 Line Losses

For most purposes in a cost allocation study, line losses are not broken out as a separate category of costs. However, the physics of energy flowing over transmission and distribution lines can lead to nontrivial costs. A line loss study is an important input into a cost of service study because it helps determine the differential cost allocations to customers served at different voltages.

A small percentage of power is lost in the form of heat as it flows through each component of the delivery system, as discussed at length in Lazar and Baldwin (2011). The losses in conductors, including transmission and distribution lines, are known as resistive loss. Resistive loss varies with the square of the quantity of power flowing through the wire. Because of this exponential relationship between load and losses, a 1% reduction in load reduces resistive losses by about 2%. The levels of conductor losses from the generators to a customer at secondary voltage (such as a residential customer) are illustrated in Figure 12. Transformers have more complex loss formulae because a certain amount of energy is expended to energize the transformer (core losses) and then all energy flowing through the transformer is subject to resistive losses. Average annual line losses typically

Figure 12. Electric delivery system line losses

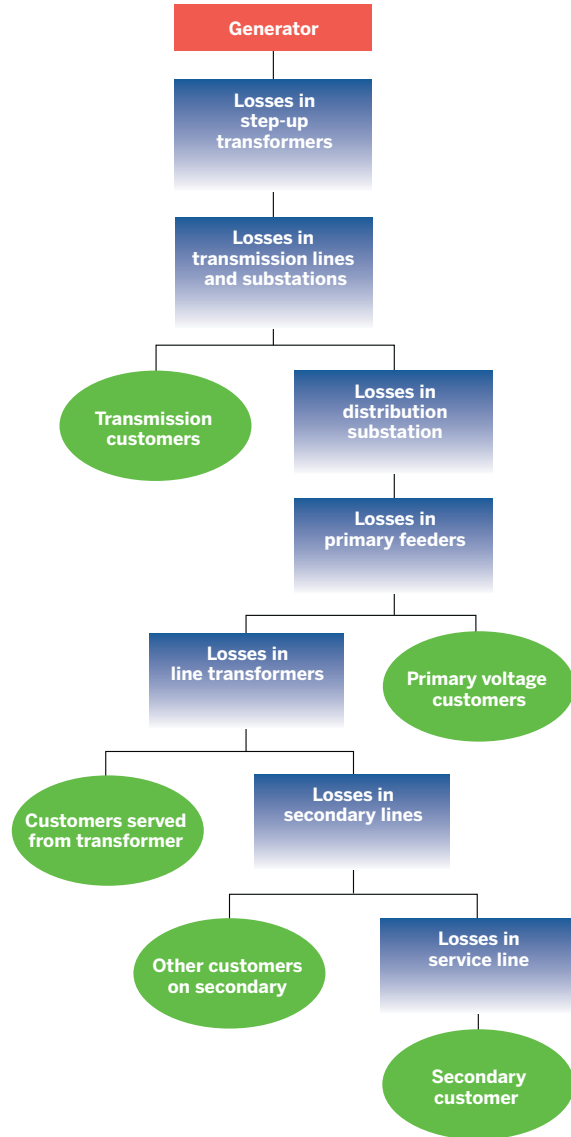

are around 7%, but marginal losses can be much higher, more than 20% during peak periods (Lazar and Baldwin, 2011, p. 1).

Reducing a customer’s load (or serving that load with an on-site generation or storage resource) reduces the losses in the service drop from the street to the customer, the secondary line (if any) serving that customer, the line transformers, the distribution feeder, the distribution substation, and transmission lines and transmission substations. Lower loads,

on-site generation and storage also reduce the generation capacity and reserve requirements, meaning that a 1-kW reduction in load at the customer's premises can avoid nearly 1.5 kW of generating capacity at a central source (Lazar and Baldwin, 2011, p. 7).

### 3.1.5 Billing and Customer Service

Traditionally, metering is considered a customer-specific expense for the purpose of billing. Advanced metering infrastructure is used for a much wider array of purposes, however, such as energy management and system planning. This indicates that broader cost allocation techniques should be used. Historically, meter reading was a substantial labor expense, with meter readers visiting each meter every billing cycle to determine usage. However, utilities with either AMI or AMR technology have either eliminated or greatly reduced the labor expenses involved. Customers that opt out of AMI often incur special meter reading costs, if meter readers are needed for a small number of customers.

Most utilities bill customers either monthly or bimonthly for a variety of related practical reasons. If customers were billed less frequently, the bills for some customers would be very large and unmanageable without substantial planning. If billed more frequently, the billing costs would be significantly higher. Billing closer to the time of consumption provides customers with a better understanding of their usage patterns from month to month, which may help them increase efficiency and respond to price signals. There are exceptions, since many water utilities, sewer utilities and even a few electric utilities serving seasonal properties may render bills only once or twice a year.<sup>15</sup>

Related to billing and metering, there are a range of investments and expenses needed to store billing data and issue bills. Historically, billing data was quite simple, and the cost of issuing bills was primarily printing and mailing costs. With AMI, billing data has grown substantially more complex, and additional system and cybersecurity requirements are needed. Conversely, online billing can lower certain costs and provide easier access to customer data.

The expenses of unpaid bills are known as uncollectibles and typically are included as an adjustment in the determination of the revenue requirement as a percentage of

expected bills in order to keep the utilities whole. Bills may go unpaid because of customer financial difficulties, departure from the service territory or any number of other factors. In some jurisdictions, deposits are required to protect utilities from unpaid bills. Utilities often use their ability to shut off electric service to a customer to ensure bill payment, and many jurisdictions implement shutoff protections to ensure that customers are not denied access to necessary or life-preserving services.

Customer service spans a whole range of services, from answering simple questions about billing to addressing complex interconnection issues for distributed generation. These expenses may vary greatly by the type of customer. Many utilities have "key accounts" specialists who are highly trained to meet the needs of very large customers. Large customers typically have more complex billing arrangements, such as campus billing, **interruptible rates** and other elements that require more time from engineering, legal and rate staff, as well as higher management. Some utilities lump these customer services together. The better practice is to keep them separate based on how each rate class incurs costs and benefits from the expenses.

Some utilities also characterize various public policy programs, such as energy efficiency programs, as customer service, but this is typically a mistake because these costs are not related to the number of customers. Instead, they relate to the power supply and delivery system capacity and energy benefits the programs provide.

Some states allow utilities to include general marketing and advertising efforts in rates, but others require shareholders to fund any such efforts. More narrowly targeted energy conservation and safety advertising expenses are often recovered from ratepayers as a part of public policy programs.

### 3.1.6 Public Policy Program Expenditures

States have mandated that utilities make expenditures for various public policy purposes. One of the largest is energy efficiency, but others include pollution control, low-income

---

<sup>15</sup> This is also the case for California customers who opt out of AMI (California Public Utilities Commission, 2014).

customer assistance, renewable resources, storage and hardening of the system to resist storm damage. Each of these cost centers has a place in the cost allocation study, and each must be treated based on the purpose for which the cost is incurred.

### 3.1.7 Administrative and General Costs

Utilities also have a wide variety of overhead costs, typically called administrative and general costs. They include necessary capital investments, known as general plant, and ongoing expenses, typically called A&G expenses. General plant includes office buildings, vehicles and computer systems. A&G expenses include executive salaries, pensions for retired employees and the expenses due to regulatory proceedings. The common thread is that these costs support all of a utility's functions.

## 3.2 Types of Utilities

Utilities differ in terms of ownership structure and the types of assets they own. The many types of electric utility organizations have different characteristics that may lead to different cost allocation issues and solutions. Nationwide, publicly owned utilities typically have lower rates. In 2016, the average residential customer served by public power paid 11.55 cents per kWh, compared with 11.62 cents for co-ops and 13.09 cents for customers served by investor-owned utilities, reflecting a mix of service territory characteristics and differing sources of electricity, costs of capital and tax burdens (Zummo, 2018). Some utilities are also vertically integrated, owning generation, transmission and distribution assets simultaneously, while others own just distribution assets.

### 3.2.1 Ownership Structures

Investor-owned utilities serve about 73% of American homes and businesses and own about 50% of electric distribution circuit miles (National Rural Electric Cooperative Association, 2017). The regulated utilities that directly serve customers may be part of larger holding companies that include other corporate assets, such as regulated utilities in other states, natural gas assets or totally unrelated enterprises. Unlike utilities owned by governments or by

the members and customers, IOUs include a return on investment, specifically a return on equity for shareholders, in the calculation of the revenue requirement. This is typically calculated as the net rate base (gross plant net of accumulated **depreciation**) multiplied by the weighted average rate of return, which is composed of the interest rate on debt and the allowed return on equity. In many states, utility commissions regulate only IOUs.

Publicly owned utilities — including municipal utilities, or munis, and public power districts — serve about 15% of American homes and have about 7% of electric distribution circuit miles (National Rural Electric Cooperative Association, 2017). Many of the areas served are urban, and municipal utilities often provide other services as well, such as water, sewer and natural gas. These utilities evolved for a variety of reasons but typically are not subject to state or federal income tax (but typically pay many other types of taxes) and do not include a return on equity in rates. For this reason, their rates tend to be lower than those of most IOUs. The state or local governmental entity that sets up this type of utility also determines the governing structure for the utility, which could be an elected or appointed board. Typically this board will hire a professional manager to oversee the utility. Many municipal utilities also determine their annual revenue requirement on a cash flow basis, which can lead to greater annual variability. In most cases, state public utility commissions have little or no authority over munis and public power districts.

Electric cooperatives are nonprofit membership corporations or special purpose districts that provide service to about 12% of Americans and own about 42% of electric distribution circuit miles (National Rural Electric Cooperative Association, 2017). They also serve more than half of the land area in the U.S. They mostly serve areas that IOUs originally declined to serve because expected sales did not justify the cost, given their shareholders' expectations for rates of return and the required investment. Some cooperatives still serve thinly populated rural areas with few large loads. Others have seen their service territories transformed to booming suburbs or industrial hubs. These entities are also exempt from federal and state income tax and do not need to include a return on equity in the revenue requirement. Unlike municipal

utilities, however, cooperatives cannot issue tax-exempt debt. Cooperatives do have flexibility to offer other services to their customers, such as broadband internet, appliance sales and repair, and contract billing and collection. Many cooperatives operate in areas with limited alternatives, and they tend to have good relationships with their member customers. An increasing number of electric cooperatives are building on these assets by entering the solar installation and maintenance field. In most states, cooperatives are entirely self-regulated, with a board being elected by the members. About 16 states regulate cooperatives, often less rigorously than they regulate IOUs (Deller, Hoyt, Hueth and Sundaram-Stukel, 2009, p. 48). This is because any “profits” remain with the member-owned cooperative and members can affect decision-making through board elections.

### 3.2.2 Vertically Integrated Versus Restructured

Vertically integrated utilities have very different cost structures than utilities in states where the electricity industry has been restructured. Vertically integrated utilities provide complete service to customers, including generation, transmission and distribution service, and their mix of resources and cost elements can be extensive. Generation costs may include utility-owned resources, long-term contract resources, short-term contract resources, storage resources, and spot market purchases and sales. Transmission costs may include resources that are utility-owned; jointly owned with other utilities; owned by transmission companies purchased on a short-term or long-term basis; or purchased through long-term arrangements with an **independent system operator (ISO)**, **regional transmission organization (RTO)**, federal power marketing agency (e.g., the Bonneville Power Administration in the Northwest and the Tennessee Valley Authority in the Southeast) or other transmission entity.

For regulated utilities in **restructured states**, some of these cost elements will be missing. In most cases, the regulated utility will not own any generation assets. The regulated entity may serve certain functions with respect to power supply, such as the procurement of **default service** (also called standard service offer) for customers who do not

choose a non-utility retail electricity supplier. However, these costs should be kept out of the cost of service study and cost allocation process and recovered within default power supply charges or as fees to retail electricity providers. In some restructured states, the regulated utilities still own certain types of transmission as a part of the regulated entity, which is subject to the traditional cost allocation process. In other states, transmission assets have been completely spun off into other entities. In many cases, the regulated utility is allowed to include these transmission costs as an allowed operating expense in determining the revenue requirement.

Depending on the mix of assets the regulated utility owns and the assets and operations of the larger holding company, which could span multiple states and even multiple countries, more complex jurisdictional allocation work may be necessary. The principles for jurisdictional allocation of generation and transmission, as well as billing and customer service, general plant and A&G expenses, are similar to those used for class cost allocation but do not have to be the same. Distribution investment costs generally are assigned to the jurisdiction where the facilities are located. Jurisdictional allocation is typically done as a part of the revenue requirement process and does not flow into the cost allocation process.

### 3.2.3 Range of Typical Utility Structures

Between the different ownership models and the mix of assets owned, there are dozens of different utility structures across the country. However, certain models are more common in particular areas:

- Nearly all IOUs outside of the restructured states are vertically integrated, owning and operating generation, transmission and distribution systems and billing customers for all of these services. Some municipal and public power entities are also vertically integrated, as well as a handful of large cooperative utilities.
- Generation and transmission (G&T) utilities own and operate power plants and often transmission lines, selling their services to other utilities (especially **distribution utilities**) and sometimes a few large industrial customers. A large portion of cooperative utilities are served by G&T cooperatives, typically owned by the distribution co-ops.

Several states have municipal power joint action agencies that build, buy into or purchase from power plants and may own or co-own transmission facilities. Many IOUs provide these services to municipal and cooperative utilities but are predominantly vertically integrated utilities serving retail customers.

- Flow-through restructured utilities operate distribution systems but do not provide generation services, leaving customers to procure those from competitive providers. Since generation prices are either set by a retail supplier in an agreement with a specific customer or determined by class from the bids of the winning suppliers in utility procurements for default service, generation cost allocation is not normally a cost of service study issue for these utilities.
- Distribution utilities own and operate their distribution systems but purchase generation and transmission

services from one or more G&T cooperatives, federal agencies, municipal power agencies, merchant generators or vertically integrated utilities or through an organized market operated by an ISO/RTO. Outside of restructured states, most distribution-only utilities are municipals or cooperatives. The cost allocation issues for these utilities are similar to those for vertically integrated utilities, with the complication that the loads driving the G&T costs may be different from the loads used in setting the charges to the distribution utility.

- Some transmission companies solely own and operate transmission systems, generally under the rules set by an RTO. Their charges may be incorporated into the retail rates of distribution and flow-through utilities. In many cases, these transmission companies are subsidiaries of larger holding companies that own other electricity assets.



## 4. Past, Present and Future of the U.S. Electric System

Chapter 3 described the basic elements of the electric system in the United States today, but these elements developed out of a 130-year history of twists and turns based on technology, fuels, regulations and even international relations. Understanding the basics of these developments and how and why today's system was formed is relevant to several important cost allocation issues discussed later in this manual. With respect to cost allocation, four primary results of these changes are worth noting:

- A shift from fuel and labor costs to capital costs.
- The transition of new generation to non-utility ownership.
- Significant levels of behind-the-meter **distributed energy resources** (DERs), including rooftop solar.
- Significant increases in the availability, quality and granularity of electric system data.

### 4.1 Early Developments

Electricity generation and delivery started in the late 19th century with three essentially parallel processes:

- Privately owned companies built power plants and delivery systems in cities and near natural generator locations, starting with small areas close to the plants.
- Industrial plants built their own generation and connected other customers to use excess capacity.
- Municipalities set up their own systems, sometimes starting with the purchase of a small private or industrial facility, to serve the population of the city or town.

Initially, these utilities operated without regulation and competed with other fuels, such as peat, coal and wood, which were locally supplied. Municipalities had internal processes to set prices, but private utilities were able to charge whatever prices they wished. In this initial period, some cities did impose “franchise” terms on them, charging fees and establishing rules allowing them to run their wires and pipes

Figure 13. Pearl Street Station, first commercial power plant in the United States



Source: Wikipedia. Pearl Street Station

over and under city streets. Multiple utilities emerged in some cities and competed against one another, which led to the building of duplicative networks of wires in many areas. These duplicative networks were aesthetically displeasing and considered by many to be economically wasteful. Relatively quickly, however, the natural monopoly characteristics led to the bankruptcy of many utilities or acquisition by a single dominant firm in each city.

In New York City, the winning utility, founded by Thomas Edison, eventually became the aptly named Consolidated Edison, or ConEd. Figure 13 depicts Edison's first generating station. New York established the first state economic regulation of electric utilities in 1900, and it spread widely from there. In New Orleans, the city remains the regulator of the IOU; its regulatory activity predated the creation of the state commission that regulates all IOUs operating outside of New Orleans.

## 4.2 Rural Electrification and the Federal Power Act

In the early period, regulatory authority over electric utilities was primarily exercised by states. In 1935, Congress passed the Federal Power Act, which vastly expanded the jurisdiction of the Federal Power Commission (now FERC) to cover interstate electricity transmission and wholesale sales of electricity. However, most economic regulation remained under the jurisdiction of state utility commissions, including authority over retail prices.

By the 1930s, most urban and suburban areas had access to electric service, but most rural areas did not. The Rural Electrification Act passed Congress in 1936, creating the Rural Electrification Administration to finance and assist the extension of service to rural areas through electric cooperatives, the Tennessee Valley Authority, various forms of public power districts and some state-sponsored utilities. The initial financing included significant federal support in the form of grants, technical assistance and very low-interest loans. A handful of states, including New York, North Carolina and Oklahoma, set up their own state power authorities to develop hydro facilities<sup>16</sup> and provide low-cost energy for economic development and other local priorities.

## 4.3 Vertically Integrated Utilities Dominate

By 1950, 90% of rural America was electrified, and access to electric service became nearly universal across the United States. Nearly all electric service was provided by vertically integrated utilities — which owned or contracted for power plants, transmission and distribution within the same

corporate entity — or by municipal entities or cooperatives. The boundaries of service between different utilities became roughly stable in this time period and reveal the unique trends in each utility's development.

Many investor-owned utilities, especially in the Midwest and West, developed service territories that look like octopuses, with major urban areas and industrial loads connected by tentacles following the paths of transmission lines.<sup>17</sup> These utilities made business decisions to extend service to particular geographic areas where they believed the potential sales revenues would justify the cost of investment in transmission or distribution and still cover the additional costs of generation and customer service necessary to serve the load.<sup>18</sup> In each case, the utility expected that the sale of electricity would generate enough revenue to justify this expenditure.

Figure 14 on the next page shows the service territories of the Texas investor-owned utilities, illustrating these patterns (Association of Electric Companies of Texas Inc., 2019). Similar patterns are evident in the service territory maps of Minnesota, Delaware, Ohio, Oregon, Washington and Virginia. IOUs and municipal utilities generally serve densely populated areas, while cooperatives and public power districts, typically created and incentivized under the Rural Electrification Act, serve less dense areas.

In some states, IOUs do serve some sparsely populated areas. This is often the result of a franchise grant by a municipality or a state mandate for service throughout an identified area to avoid islands where service is unavailable. The cost of this rural service is, to the utility, a price it must pay for access to the more densely populated area for a viable business, although ratepayers typically bear the higher costs of service.

16 Some of these state entities eventually assumed ownership of other types of generation.

17 In some states, such as Massachusetts, most of Maryland, Rhode Island and New Jersey, the IOUs serve large contiguous areas, regardless of density, due to historical and legal conditions in each state. In essence, the utilities incurred an obligation to serve less-developed areas as a price of obtaining authority to serve more densely populated areas.

18 In some cases, the IOU picked up dispersed service territory during the process of acquiring the assets of other power producers or to obtain state or local licenses for generation or transmission facilities.

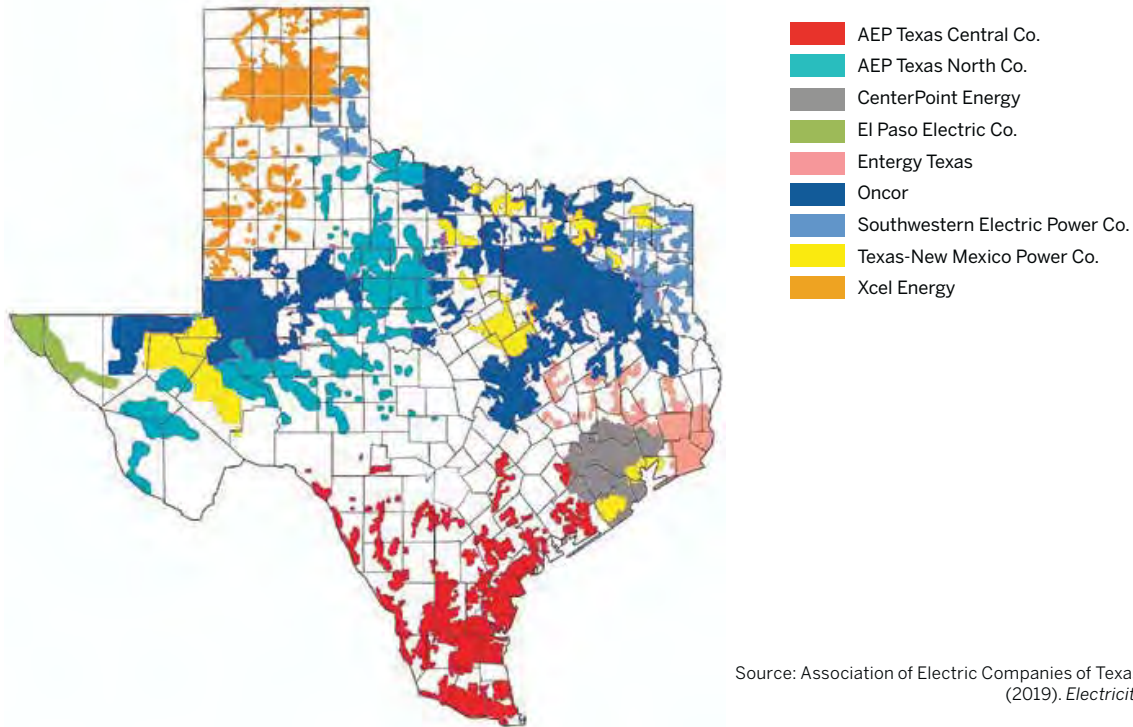
**Figure 14. Investor-owned electric utility service territories in Texas**

Source: Association of Electric Companies of Texas Inc. (2019). *Electricity 101*

A cost analyst may need to examine these costs carefully to avoid shifting them to specific customer classes and to spread these costs systemwide.

#### 4.4 From the Oil Crisis to Restructuring

From the 1950s to the early 1970s, electric sales skyrocketed due to a wide range of new electric end uses, and prices were relatively stable. However, the cost structure of the utility industry changed drastically after the 1974 oil crisis. Demand fell rapidly, particularly in locations where oil was used to generate electricity, in response to large price increases and fuel shortages. Natural gas prices, which had been partly regulated, were gradually deregulated over the next decade, but natural gas was thought to be in short supply and available only for certain uses. No new baseload power plants running more than 1,500 hours a year could be run on oil or natural gas under the Powerplant and Industrial Fuel Use Act of 1978,

which was later repealed. In addition, generation of electricity with natural gas was to be prohibited at existing plants by 1990, with an exception for certain combined heat and power (CHP) facilities (Gordon, 1979). This law accelerated a trend toward the construction of large capital-intensive nuclear and coal power plants across the country in order to get away from the use of oil and natural gas for electricity. The confluence of all these trends, including high oil prices and expensive capital-intensive plants entering the rate base, led to major increases in electricity prices, as depicted in Figure 15 on the next page using U.S. Energy Information Administration data (2019).

Congress also passed PURPA in 1978, which included provisions intended to open up competition in the provision of electricity and to reform state rate-making practices. On the competition side, PURPA required electric utilities to purchase power from independent producers at long-term prices based on **avoided costs**. With regard to state rate-making practices, PURPA also required state commissions

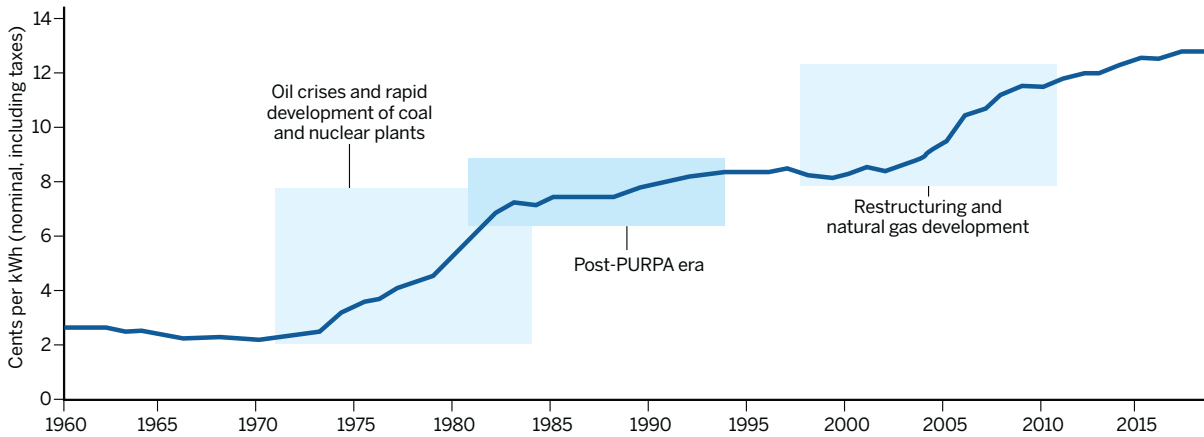
**Figure 15. US average retail residential electricity prices through 2018**

Data source: U.S. Energy Information Administration. (2019, March). *Monthly Energy Review*

to consider a series of rate-making standards, including cost of service. This standard was widely adopted, but neither PURPA nor the state commissions defined “cost of service.”<sup>19</sup> PURPA also requires some method to assure consumer representation in the consideration of rate design, through either a state consumer advocate or intervenor funding.

The widespread end result was low-cost energy generation (particularly after the fall in oil and gas prices in 1985-1986) and excess capacity in the 1980s, meaning the wholesale price of power was often much lower than full retail rates, even the supply portion of those rates. As a result, large industrial power users and municipalities began demanding the right to become wholesale purchasers of electricity. Given the changes in fuel markets, Congress repealed the limits on natural gas usage for electricity in the Natural Gas Utilization Act of 1987.

During the 1980s, major changes occurred in the telecommunications and natural gas industries, often termed deregulation but more accurately described as restructuring. Following these trends and the demands of larger purchasers for lower rates, Congress passed the Energy Policy Act

of 1992.<sup>20</sup> This law called for open access to transmission service and paved the way for restructuring of the electric industry, including organized wholesale markets. In several parts of the country, including Texas and the Northeast, Midwest and West Coast, many states followed these trends and passed restructuring acts in the late 1990s, which required formal separation of certain asset classes and, in some cases, total divestment of generation assets. In several parts of the country, following voluntary criteria articulated by FERC in 1996, independent system operators were created to formalize independent control of the electric system and to administer organized wholesale markets for energy supply. FERC also articulated voluntary criteria in 1999 to form regional transmission organizations, which contain many of the same elements as the earlier ISO requirements (Lazar, 2016, pp. 21-23). There are currently six ISOs/RTOs operating solely in the U.S., two operating exclusively in Canada and one that includes areas in both countries:

- California Independent System Operator (CAISO).
- Electric Reliability Council of Texas (ERCOT).
- Midcontinent Independent System Operator (MISO),

<sup>19</sup> The relevant provision of PURPA merely states: “Rates charged by any electric utility for providing electric service to each class of electric consumers shall be designed, to the maximum extent practicable, to reflect the costs of providing electric service to such class” (16 U.S.C. § 2621[d][1]). This was clarified by the 2005 amendments to include “permit identification of differences in cost-incurrence, for each such class

of electric consumers, attributable to daily and seasonal time of use of service” (16 U.S.C. § 2625[b][1]).

<sup>20</sup> Pub. L. 102-486. Retrieved from <https://www.govinfo.gov/content/pkg/STATUTE-106/pdf/STATUTE-106-Pg2776.pdf>

spanning from North Dakota through Michigan and Indiana and down to Louisiana while also including the Canadian province of Manitoba.

- ISO New England (ISO-NE).
- New York Independent System Operator (NYISO).
- PJM Interconnection, spanning from New Jersey down through part of North Carolina and extending west through West Virginia and Ohio, while also including the Chicago area.
- Southwest Power Pool (SPP), spanning from North Dakota down through Arkansas, Oklahoma and northern Texas.
- Alberta Electric System Operator (AESO).
- Independent Electricity System Operator (IESO) in Ontario.

Organized wholesale markets for energy supply provide for structured competition among owners of power plants while meeting reliability and other constraints. These markets provide a nominal framework for competition but are in actuality much more deliberately constructed than any actual competitive markets that do not have the same reliability obligations. Cost analysts should pay careful attention to whether wholesale market structures and tariffs truly reflect cost causation.

In some states, retail customers were also given the option of choosing a new retail electricity supplier for the energy component of their rates, typically with utility-procured “basic” or default energy service as the more widely used option.<sup>21</sup> FERC regulates ISOs and RTOs, as well as the organized wholesale markets they run. However, each traditional regulated utility retained ownership of the distribution system as a natural monopoly regulated by the state, and states are the primary regulatory entity for retail electricity suppliers.

Several more states were either in the beginning stages of restructuring or contemplating restructuring in the early 2000s when a backlash from events in restructured states halted this trend. Chief among these events was the California energy crisis, where a drought-induced supply shortfall enabled energy traders to manipulate newly formed energy markets. In combination with infrastructure limitations and

other features of the new California rules, this led to high wholesale market prices, the bankruptcy of one of the nation’s largest utilities and even the recall and removal of California’s governor.

## 4.5 Opening of the 21st Century

The beginning of the 21st century has seen another wave of dramatic change in the electric sector. Restructured areas have seen significant changes in investment patterns. New natural gas combined cycle plants have become a much more important source of generation. Aided by a drop in natural gas prices due to innovations in drilling technology, they have been able to outcompete other types of generation. This has meant significant retirements of other types of generation, starting with older oil and coal units, which have also been affected by new pollution control requirements over the last several decades. More recently, nuclear plants built in the 1960s through 1980s have started to be retired, or their owners have claimed that low energy market prices require additional financial support to enable their continued operation.

In addition, global market developments and federal, state and local policies for renewable generation, as well as energy efficiency and demand response, have led to significant expansions in new resources that have zero pollution and low marginal costs. Many states have adopted **renewable portfolio standards (RPS)** to accelerate the adoption of new renewable technologies, sometimes with requirements for solar or other specific technologies. Storage technology innovation has further increased options for grid flexibility and reliability. New technologies to monitor and manage the electricity grid have also become much more prevalent as a result of continued innovation, cost decreases and policy support.

Some jurisdictions are looking at how to maximize the benefits of customer-sited investments in energy efficiency, energy management and distributed generation. Notable examples are the Reforming the Energy Vision process in

---

<sup>21</sup> Texas is the exception, without any option for utility-provided energy supply service.

New York, E21 in Minnesota and the distribution resources plan proceedings in California. These efforts may even extend to new market structures at the retail level and new platforms for customers and third parties to exchange data and to offer and receive new types of services.

Changes in the electricity system affect many parts of the cost allocation process.

First, a utility cost study performed in 1980 might have placed 70% of the utility revenue requirement in the categories of fuel and purchased power, which are generally considered short-run variable energy-related costs. Since that time, capital has been substituted for fuel, in the form of wind, solar, nuclear and even high-efficiency combined cycle units running on low-cost natural gas. Many variable labor costs for customer service and distribution employees, including meter readers, have been displaced with capital investments in distribution automation and smart grid technologies. As energy storage evolves, even peak hour needs may be met with no variable fuel costs incurred in the hour when service is actually provided. Instead, power may be generated in one period with a variable renewable resource with no fuel cost<sup>22</sup> and saved for a peak hour in a storage system with almost no variable operating costs.

Second, a significant share of electricity generation is now owned by non-utility investors. Some of this shift is

driven by federal tax code provisions, some is due to the emergence of specialized companies that build and operate specific types of power generating facilities, and some is due to public policy decisions to limit ownership of generating resources by traditionally regulated utilities. As a result, costs attributable to these sources of generation are primarily the cost of the energy — which is not divided up into capital costs, maintenance costs, etc., as it was when the generation plant was owned and operated by the utility. The 2005 amendments to PURPA, which state that time-differentiated cost studies must be considered, provide an imperative to think carefully about how to assign costs to time periods.

Third, a range of supportive state and federal policies, combined with falling costs, have led to major increases in DERs, notably rooftop solar. Advanced energy storage may be the next great wave on this front, enabling both widespread energy management and backup power resources.

Fourth, today's sophisticated data and analytical capabilities present regulators and analysts alike with a wide range of new choices. Several decades ago, analysts were limited to simple categorizations and shortcuts. This includes the traditional division of costs as customer-related, demand-related or energy-related. Regulators are no longer bound by these limitations and should seek to improve on dated techniques.

---

<sup>22</sup> For example, Xcel Energy has put forward a "steel for fuel" program, which substitutes wind and solar facilities for fuel-burning power plants (Xcel Energy, 2018, p. 5).

# Works Cited in Part I

- Association of Electric Companies of Texas Inc. (2019). *Electricity 101*. Retrieved from <http://www.aect.net/documents/2019/AECT%20Electricity%20101%202019.pdf>
- Bonbright, J. (1961). *Principles of public utility rates*. New York, NY: Columbia University Press.
- California Public Utilities Commission. (2014, December 18). *Decision regarding smartmeter opt-out provisions*. Application No. 11-03-014 et al., Decision No. 14-12-078. Retrieved from <http://docs.cpuc.ca.gov/PublishedDocs/Published/G000/M143/K904/143904205.PDF>
- Daniels, L. (1988, January 29). Bankruptcy filed by leading utility in Seabrook plant. *The New York Times*. Retrieved from <https://www.nytimes.com/1988/01/29/business/bankruptcy-filed-by-leading-utility-in-seabrook-plant.html>
- Deller, S., Hoyt, A., Hueth, B., and Sundaram-Stukel, R. (2009). *Research on the economic impact of cooperatives*. Madison: University of Wisconsin Center for Cooperatives. Retrieved from [http://reic.uwcc.wisc.edu/sites/all/REIC\\_FINAL.pdf](http://reic.uwcc.wisc.edu/sites/all/REIC_FINAL.pdf)
- Garfield, P., and Lovejoy, W. (1964). *Public utility economics*. Englewood Cliffs, NJ: Prentice Hall.
- Gordon, R. (1979). The Powerplant and Industrial Fuel Use Act of 1978 — an economic analysis. *Natural Resources Journal* 19(4). Retrieved from <https://digitalrepository.unm.edu/cgi/viewcontent.cgi?referer=&httpsredir=1&article=3074&context=nrj>
- Kahn, A. (1970 and 1971). *The economics of regulation: Principles and institutions* (vols. 1 and 2). New York, NY: John Wiley & Sons.
- Lazar, J. (2014). *Performance-based regulation for EU distribution system operators*. Montpelier, VT: Regulatory Assistance Project. Retrieved from <https://www.raonline.org/knowledge-center/performance-based-regulation-for-eu-distribution-system-operators/>
- Lazar, J. (2016). *Electricity regulation in the United States: A guide* (2nd ed.). Montpelier, VT: Regulatory Assistance Project. Retrieved from <https://www.raonline.org/knowledge-center/electricity-regulation-in-the-us-a-guide-2/>
- Lazar, J., and Baldwin, X. (2011). *Valuing the contribution of energy efficiency to avoided marginal line losses and reserve requirements*. Montpelier, VT: Regulatory Assistance Project. Retrieved from <https://www.raonline.org/knowledge-center/valuing-the-contribution-of-energy-efficiency-to-avoided-marginal-line-losses-and-reserve-requirements/>
- Lazar, J., and Gonzalez, W. (2015). *Smart rate design for a smart future*. Montpelier, VT: Regulatory Assistance Project. Retrieved from <https://www.raonline.org/knowledge-center/smart-rate-design-for-a-smart-future/>
- Linville, C., Lazar, J., Dupuy, M., Shipley, J., and Brutkoski, D. (2017). *Smart non-residential rate design: Optimizing rates for equity, integration, and DER deployment*. Montpelier, VT: Regulatory Assistance Project. Retrieved from <https://www.raonline.org/knowledge-center/smart-non-residential-rate-design/>
- Linville, C., Shenot, J., and Lazar, J. (2013). *Designing distributed generation tariffs well: Fair compensation in a time of transition*. Montpelier, VT: Regulatory Assistance Project. Retrieved from <https://www.raonline.org/knowledge-center/designing-distributed-generation-tariffs-well/>

Littell, D., Kadoch, C., Baker, P., Bharvirkar, R., Dupuy, M., Hausauer, B., Linvill, C., Midgen-Ostrander, J., Rosenow, J., Xuan, W., Zinaman, O., and Logan, J. (2017). *Next-generation performance-based regulation: Emphasizing utility performance to unleash power sector innovation* (NREL/TP-6A50-68512). Montpelier, VT and Golden, CO: Regulatory Assistance Project and National Renewable Energy Laboratory. Retrieved from <https://www.raponline.org/knowledge-center/next-generation-performance-based-regulation-emphasizing-utility-performance-unleash-power-sector-innovation/>

National Association of Regulatory Utility Commissioners. (1992). *Electric utility cost allocation manual*. Washington, DC: Author. Retrieved from <https://pubs.naruc.org/pub/53A3986F-2354-D714-51BD-23412BCFEDFD>

National Rural Electric Cooperative Association. (2017). *America's electric cooperatives: 2017 fact sheet*. Retrieved from <https://www.electric.coop/electric-cooperative-fact-sheet/>

Phillips, C. (1984). *The regulation of public utilities* (1st ed.). Arlington, VA: Public Utility Reports.

U.S.-Canada Power System Outage Task Force. (2004). *Final report on the August 14, 2003 blackout in the United States and Canada: Causes and recommendations*. Retrieved from <https://www.energy.gov/sites/prod/files/oeprod/DocumentsandMedia/BlackoutFinal-Web.pdf>

U.S. Department of Energy. (2015). *United States electricity industry primer* (DOE/OE-0017). Washington, DC: Author. Retrieved from <https://www.energy.gov/sites/prod/files/2015/12/f28/united-states-electricity-industry-primer.pdf>

U.S. Energy Information Administration. (2019, March). *Monthly energy review* (DOE/EIA-0035 [2019/3]). Table 9.8. Washington, DC: Author. Retrieved from <https://www.eia.gov/totalenergy/data/monthly/index.php>

Xcel Energy. (2018, October 2-4). *Leading the energy future* [Presentation at the Wolfe Research Conference]. Retrieved from [investors.xcelenergy.com/file/4025308/Index?KeyFile=1500113448](https://investors.xcelenergy.com/file/4025308/Index?KeyFile=1500113448)

Zummo, P. (2018). *Coast to coast, public power costs less*. Arlington, VA: American Public Power Association. Retrieved from <https://www.publicpower.org/periodical/article/coast-coast-public-power-costs-less>



## **Part II: Overarching Issues and Frameworks for Cost Allocation**

## 5. Key Common Analytical Elements

Several key analytical processes and decisions must be made regardless of the overall framework and specific methods used for cost allocation. These common analytical elements include:

- Cost drivers: What are the key factors that lead different types of costs to be incurred?
- Determining customer classes: How many classes of customers should be categorized separately, and how is each class defined?
- Load research and data collection: What are the key patterns of load, delivery and generation that need to be recorded and analyzed? For any key data that are not tracked comprehensively, is sampling or another approach used?

In any individual rate case, these issues may not be litigated at great length, and many or all parties may rely on past practices and precedent. But the decisions made on these issues historically by each public utility commission can have important consequences in the present, particularly as changes to technology and the regulatory system undermine the basis of past assumptions.

### 5.1 Cost Drivers

Effective cost allocation and rate design require the identification of central cost causation factors, or cost drivers. Within these processes, it is important to identify relatively simple metrics (e.g., energy use in various periods, demand at various times, numbers of customers of various types) that can be associated with the various customer classes. The cost allocation process, by its nature, approximates cost responsibility and is not a tool of exceedingly precise measurements.

One crucial underlying reality is that customers use electricity at different times, leading to the concept of **load diversity**. Load diversity means the shared portions of the system need to be sized to meet only the **coincident peak (CP)** loads for combined customer usage at each point of the system,<sup>23</sup> rather than the sum of the **customers' noncoincident peak (NCP) loads**.<sup>24</sup> This diversity exists on every point of the system:

- Customers sharing a transformer have diverse loads.
- Loads along a distribution feeder circuit have diversity.
- Multiple circuits on a substation have diversity.
- The substations served by a transmission line have load diversity.
- Individual utilities in an ISO territory or regional transmission interconnection have diversity.

Diversity of load means the actual electricity system is significantly less expensive than a system that would be built to serve the sum of every customer's individual NCP. Holding **peak load** for a customer constant, this also means that a customer with load that varies over time is effectively much cheaper to serve than a customer that uses the same peak amount at every hour. The former customer can share capacity with other customers who use power at other times, but the latter cannot.

Another important reality is that the accounting category to which a cost is assigned does not determine its causation. An expense item may be due to energy use, peak demands or number of customers; the same is true for capital investments. Capital costs and other expenses that do not vary with short-run dispatch changes are referred to as fixed costs by some analysts, and some cost of service studies assume that

<sup>23</sup> As explained throughout this section, the critical coincident peak load may be a single peak hour but more typically is some combination of loads over multiple hours.

<sup>24</sup> Several other terms are used for individual customers' noncoincident peak demand, including "undiversified maximum customer demand." Unfortunately, both "NCP" and "maximum customer demand" can also be

used to refer to various class peaks, particularly when used with modifiers. This manual will use "customer NCP" to refer to individual customer peaks and "class NCP" to refer to aggregated peaks by class, often specifying the level of the system for the relevant class NCP. Class NCP is sometimes referred to as the maximum class peak, maximum diversified demand or other similar terms.

these notionally fixed costs cannot be driven by energy use. As discussed in the text box on pages 78-79, this assumption is incorrect. Utilities make investments and commit to “fixed” expenses for many reasons: to meet peak demands, to reduce fuel costs, to reduce energy losses, to access lower-cost energy resources and to expand the system to attract additional business. As a result, this manual will use the phrase “dispatch O&M costs” to reflect operations and maintenance costs that vary directly with generation output and “nondispatch O&M costs” for O&M costs that are incurred independently of output levels.

### 5.1.1 Generation

There are several different categories of generation costs, with different lengths of time for the commitment. Depending on the technologies in question, long-term capital costs, nondispatch O&M costs and per-kWh fuel costs are substitutable — that is, a wind generator with a battery storage system involves more capital cost and lower operating cost than a natural gas combustion turbine unit with the same output.

The longest-lived category of generation costs is capital investment in generation facilities, which are often depreciated on a 30-year timeline and can last even longer. Once the investment is made, the depreciation expense typically will not vary over that time. Of course, a generation facility can be permanently shut down (retired), temporarily shut down (mothballed) or repurposed before the depreciation period is over. Different costs and benefits may be incurred for each of these three options. It is also possible for a plant’s life to be recalculated at some point, with an appropriate change in the depreciation schedule and the annual depreciation expense.

There can be significant capital investments and nondispatch O&M costs that are incurred on an annual or monthly basis, which may not vary directly with the numbers of hours the facility operates. There are also capital investments that are driven by wear and tear, rather than the passage of time.<sup>25</sup>

The shortest-term variable costs for utilities are mostly fuel costs and the portions of power purchases that vary with energy taken. In addition, some O&M costs are usually

considered variable with output: the costs of some consumable materials (especially for pollution control equipment), as well as the costs of replacements (such as lubricants and filters) and overhauls that are required after a specified amount of output, equivalent full-load hours of operation or similar measures.<sup>26</sup>

In many cases, utilities classify costs based on accounting data and administrative convenience, rather than the underlying reasons why the costs were incurred and why any capital investments are still part of the system. For example, utilities may treat some O&M and interim capital additions as variable and energy-related for one set of purposes, such as rate design or evaluation of potential generation resources, but treat the same costs as demand-related for cost allocation purposes for simplicity. Cost of service studies are normally driven primarily by accounting data that do not readily differentiate dispatch O&M costs from nondispatch O&M costs and capital additions.

Similarly, other costs, such as pollution controls and ash handling and disposal at coal plants, include significant long-run investments that were specifically incurred to support the energy generation process and generally should be treated as energy-related. These investments would not be needed or would be less costly either if the plant were run less often or if the fuel were less polluting.

#### Short-Run Variable Generation Costs

The short-run variable cost of power generation is typically straightforward, primarily entailing a mix of fuel costs, dispatch O&M costs for utility-owned generation and purchased power. As a result, the drivers of these costs are typically fuel prices, market prices for energy and any ongoing contracts the utility has. Utilities can hedge the risk of short-term energy generation costs through a wide range of means, including futures contracts for fuel and power.

The short-run variable costs of some generation facilities, including storage and dispatchable hydro, are very low. Storage facilities require the operation of other resources (which may well have variable costs) to charge them. Dispatch

25 These costs are comparable to tire replacements that are caused by wear and tear closely correlated with miles driven.

26 These costs are comparable to the costs of automotive oil changes and routine services that are the consequence primarily of miles driven.

decisions for storage and dispatchable hydro resources are typically made to maximize the benefits from the limited supply of other time-shiftable generation resources.

Prior to PURPA, most long-term purchased power contracts had separate capacity and energy elements. These were mostly for fuel-dependent power plants. This rate form allowed the owner to obtain capital cost recovery in a predictable payment and the receiving utility to control the output as needed to fit varying loads, paying for short-run variable costs as incurred. Today many power purchase contracts are expressed entirely on a volumetric basis, based on an expected pattern of output. This change in how contracts are priced in the wholesale market does not dictate any particular approach to how costs are allocated in the retail rate-setting process.

### Generation Capacity Costs

Beyond these energy needs, most regions of the United States also plan around the amount of shared generation capacity needed, and these processes can drive a significant amount of generation costs. The amount of capacity required by a utility system, typically denominated in **megawatts** (MWs) or gigawatts at the time of the system coincident peak, determines whether the utility should retire existing plants, add new resources or delay planned retirements, or keep the system as it is. All those decisions have costs and benefits. This determination may be made by an ISO/RTO, a holding company or other aggregation of interconnected load.

Although the typical planning procedures used to date by utilities and ISOs have often served their original purposes to measure the least-cost resources available at the utility system level, these procedures often oversimplify important aspects of overall capacity and reliability issues. The key principle is that reliability-related costs are not all “caused” by one hour or a few hours of demand during the year. A system must have some form and level of capacity available at all hours. Loss-of-energy expectation<sup>27</sup> studies generally show that

adding capacity at any hour to a system, even **off-peak** hours, has a small but discernible beneficial impact on reliability. Many resources can be justified only if all of the attributes are considered, including contribution to meeting peak demand and contribution to meeting other needs such as fuel cost reduction.

The typical vertically integrated utility calculates the installed capacity requirement by determining what amount of existing and new capacity will provide acceptable reliability, measured by such statistical parameters as the mathematical expected value of the number of hours in which it cannot serve load or of the amount of customer energy it will not be able to serve in a year, due to insufficient available generation. Those expected values are computed from models that simulate the scheduling of generation maintenance and the random timing of forced outages for many potential combinations of outages and load levels. In large portions of North America, the capacity requirement is determined regionally by an ISO/RTO and then allocated to the load-serving entities, transmission control areas or utilities.<sup>28</sup>

Required reserves are usually expressed as the percentage **reserve margin**, which is:

$$\begin{aligned} &(\text{capacity} - \text{peak load}) \div \text{peak load}; \text{ or} \\ &(\text{capacity} \div \text{peak load}) - 1 \end{aligned}$$

Capacity may be defined as installed capacity, demonstrated capacity or unforced capacity (installed capacity reduced by the resource’s forced outage rate). There may be special provisions to recognize that an installed MW of solar, wind or seasonal hydro capacity is not equivalent to an installed MW of combustion turbine capacity with guaranteed fuel availability or a MW of battery storage capacity located at a distribution substation. Capacity requirements may also be satisfied with curtailable load, energy storage or expected price response to peak pricing. The cost of capacity to meet a very short-term need is very different from the cost of **baseload capacity** that serves customers around the clock

27 Different analysts refer to related measures as loss-of-load hours, loss-of-load expectation, expected unserved energy and loss-of-load probability.

28 Some of the utilities in the ISOs/RTOs are restructured and do not provide generation services, so the cost of service study need not deal with

generation costs. However, all the utilities in the SPP and most of those in MISO are vertically integrated, as are some jurisdictions in PJM (West Virginia, Virginia, Kentucky and the PJM pieces of North Carolina, Indiana and Michigan) and ISO-NE (Vermont) and municipal and cooperative utilities in most restructured jurisdictions.

and throughout the year, and the cost analyst must be aware of these differences.

Peak load is generally the utility's maximum hourly output requirement under the worst weather conditions expected in the average year (e.g., the coldest winter day for winter-peaking utilities or the hottest summer day for summer-peaking utilities). In the ISOs/RTOs, the peak load is usually the utility's contribution to the actual or expected ISO/RTO peak load. Although the reserve margin is often stated on the basis of a single peak hour as a matter of measurement convention, the derivation of the reserve margin takes into account far more information than the load in that one hour. The most important parameters in determining the required reserve margin are the following:

- **Load shape**, especially the relationships among the annual and weekly peaks and the number of other hours with loads close to the peaks. The system must have enough reserve capacity to endure generation outages at the high-load hours. The near-peak hours matter because the probability of any given combination of outages coinciding with the peak hour is very low, but if there are hundreds of hours in which that combination of outages would result in a supply shortage, the probability of loss of load would be much larger.
- **Maintenance requirements.** Utilities attempt to schedule generator maintenance in periods with loads lower than the peak, typically in the autumn and spring, and occasionally in the winter for strongly summer-peaking utilities and in the summer for strongly winter-peaking utilities. Utilities with both modest maintenance requirements and several months with loads reliably well below those in the peak months can schedule all routine maintenance in the off-peak months while leaving enough active capacity to avoid any significant risk of a capacity shortage in those months. But many utilities have large maintenance requirements (especially for coal-fired and nuclear units) and only modest reductions in peak exposure in the shoulder months. After subtracting required maintenance, the effective reserve margin may be very similar throughout the year, increasing the chance that a combination of outages will result in loss of load. As a result, high loads in any month (or perhaps any

week) contribute to the need for installed capacity.

- **Forced outage rates.** All generation units experience some mechanical failures. The higher the frequency of forced outages, the more likely it is that a relatively high-load hour will coincide with outages, eliminating available reserve and resulting in the loss of load.
- **Unit sizes.** If all of a system's units were very small (say, under 1% of system peak), the random outages could be expected to spread quite evenly through the year. With larger units, outages are much lumpier, and loss of a small number of large units can create operating problems. Hence, systems with larger units tend to need higher reserve margins, all else being equal.
- **Other operating constraints.** Although hydro resources have the highest overall reliability, they produce power only when water is available to run them. Some hydro resources are required to be operated for flood control, navigation, irrigation, recreation, wildlife or other purposes, and these other constraints may affect the ability of the resource to provide power at full capacity when system peak loads occur.

Some of the factors in this list affect the reliability value of various types of generation, while others highlight the types of load that increase required capacity reserve levels. A large unit with frequent forced outages may contribute little to ongoing system reliability even though it has a significant nameplate capacity. If such a unit has high ongoing costs that could be reduced or eliminated through retirement, continued operation must primarily be justified by its energy benefits. On the demand side, long daily periods of high loads can mean that many weekday hours (and even some weekend hours) in each month will contribute to capacity requirements, proportionately shifting capacity responsibility toward customers with high **load factors**. Table 2 on the next page summarizes cost drivers for power supply capacity.

The value of capacity is partly a function of the type of capacity and the location of that capacity. Although required capacity (measured in MWs) is determined by demand in a subset of hours, along with the characteristics of the power plants, the cost of capacity (measured in dollars per MW-year) is in large part determined by energy requirements.

In the previous millennium, the cheapest form of

**Table 2. Cost drivers for power supply**

Resource type	Purpose	Investment-related costs	Maintenance costs	Fuel costs
<b>Baseload nuclear, geothermal</b>	Power at all hours	High	High	Low
<b>Coal, intermediate combined cycle</b>	Power at many hours	Medium	Medium	Medium
<b>Peaking</b>	Power in peak hours, plus reserves at all hours	Low	Low	High
<b>Hydro</b>	Power at some or all hours	Very high	Low	Low or none
<b>Wind</b>	Power at some hours	High	Low	None
<b>Solar</b>	Power at some hours	High	Low	None
<b>Storage</b>	Power at peak hours, plus reserves at all hours	High	Low	Low — for purchased kWhs

capacity to serve peak needs was typically considered to be a combustion turbine. These units had low investment costs and low ongoing O&M expenses but were inefficient and typically used more expensive fuels. These characteristics made them perfect to run infrequently during peak times and for other short-term reliability needs. Conversely, it made sense to make major investments in units with high upfront costs but high efficiency and cheap fuel prices and to run these units nearly year-round. These major investments were driven by year-round energy requirements, not peak loads.

Today, in contrast, the least expensive form of capacity to serve extreme peak loads may not be a generating unit at all. For very low-duration loads, demand response, customer response to critical peak pricing or battery storage may be the least-cost resource to serve a very short-duration peak, sometimes described as a needle peak. The ability to curtail an end-use load saves not only the amount of capacity represented by the reduced load but also the marginal line losses and reserves that would be required to reliably sustain that load. Similarly, the ability to dispatch DERs also avoids line losses that would be required to deliver generated capacity to that location.<sup>29</sup>

### 5.1.2 Transmission

The costs of transmission lines depend on the length of the lines, the terrain they must cover and the amount of power they need to carry at different times, sometimes in either direction. The maximum usage of many transmission lines is not necessarily at system peak hours, and the usage

of certain lines can change significantly over time. Carrying more power requires larger conductors, multiple conductors and/or higher voltages, all of which increase costs.

If each load center in a utility's territory had about the amount of generation required to meet its peak load, and the power plants were similar so the utility had no interest in exporting power from one area to another, the transmission system would exist primarily to allow each load center to draw on the others for backup supply when local generation was unavailable. In real utility systems, power plants are often distributed very differently from load, with large centralized plants built to capture economies of scale, often in areas far from major load centers. Generation may be sited remotely away from load for environmental reasons, to facilitate access to fuel and to minimize land costs and land use conflict. Generation plants also tend to vary considerably in fuel cost, efficiency and flexibility; allowing the utility to use the least-cost mix of generation at all load levels may require additional transmission.

By contrast, demand response, energy efficiency and energy storage can be very carefully targeted geographically to provide needed capacity in a specific area without the need for any additional transmission.

Although separating all the causes of the structure of an existing transmission system can be difficult, especially for a

<sup>29</sup> The capacity saved can be as high as 1.4 times the load reduced, when marginal line losses and reserves are taken into account. For a detailed discussion of this, see Lazar and Baldwin (2011).

utility whose distribution of load and generation has changed over the decades, decisions about the nature and location of generation facilities can have important effects on the costs of the transmission system.

Energy load over the course of many hours also affects the sizing and cost of transmission. Underground transmission is particularly sensitive to the buildup of heat around the lines, so the duration of peak loads and the extent to which loads decline from the peak period to the off-peak period affects the sizing of underground lines. An underground line may be able to carry twice as much load for a 15-minute peak after a day of low loads as for an eight-hour peak with a high daily load factor. To reduce losses and the buildup of heat from frequent high loads, utilities must install larger cables, or more cables, than they would to meet shorter duration loads.

The capacity of overhead lines is often limited by the sagging caused by thermal expansion of the conductors, which also occurs more readily with summer peak conditions of high air temperatures, light winds and strong sunlight. Overheating and sagging also reduce the operating life of the conductors. A transmission facility normally will have a higher capacity rating for winter than for summer because the heat buildup is ameliorated in cooler weather.

The costs of substations, including the power transformers on which they are centered, are determined by both peak loads and energy use. The capacity of a station transformer is limited by the buildup of heat created by electric energy losses in the equipment. Every time a transformer approaches or exceeds its rated capacity (a common occurrence, since transformers can typically operate well above their rated capacity for short periods), its internal insulation deteriorates and it loses a portion of its useful life.

Figure 16 illustrates the effect of the length of the peak load, and the load in preceding hours, on the load that a transformer can carry without losing operating life (Bureau of Reclamation, 1991, p. 14). The initial load in Figure 16 is defined as the maximum of the average load in the preceding

**Figure 16. Permissible overload for varying periods**

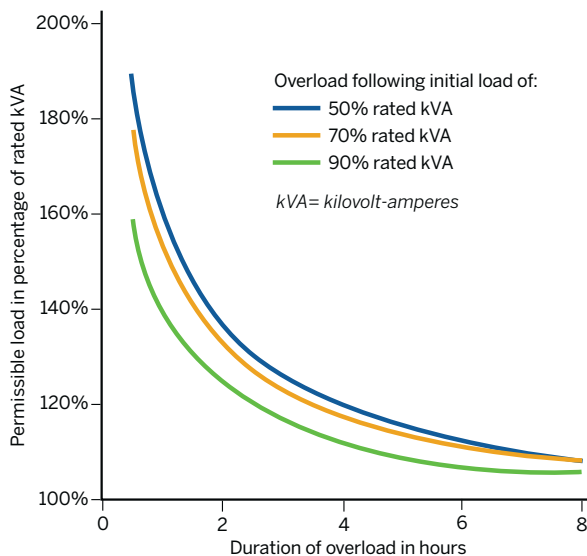

Source: Bureau of Reclamation. (1991). *Permissible Loading of Oil-Immersed Transformers and Regulators*

two hours or 24 hours.<sup>30</sup> A transformer that was loaded to 50% of its rating in the afternoon can endure an overload of 190% for 30 minutes or 160% for an hour. If the afternoon load was 90% of the transformer rating, it could carry only 160% of its rated load for 30 minutes or 140% for an hour.<sup>31</sup>

Similarly, if the transformer's high-load period is currently eight hours in the afternoon and evening, and the preceding load is 50% of rated capacity, afternoon load reductions that cut the high-load period to three hours would increase the permissible load from about 108% of rated capacity to about 127%. Under these circumstances, the transformer can meet higher load without replacement or addition of new transformers.

Short peaks and low off-peak loads allow the transformer to cool between peaks, so it can tolerate a higher peak current. Long overloads and higher load levels increase the rate of aging per overload, and frequent overloads lead to rapid failure of the transformer.

30 This specific example is for self-cooled and water-cooled transformers designed for a 55 degrees Celsius temperature rise; other designs show similar patterns.

31 Utilities recognize that the length of overloads is critical to determining whether a transformer needs to be replaced. For example, Potomac

Electric Power Co. (Pepco) in Maryland has established standards for replacing line transformers when the estimated average load over a five-hour period exceeds 160% of the rating of overhead transformers or 100% for pad-mounted transformers (Lefkowitz, 2016, p. 41). The company has not found it necessary to establish comparable policies for shorter periods.

**Table 3. Cost drivers for transmission**

Connection to (or between)	Purpose	Typical length of line	Investment-related costs	Maintenance costs
<b>Remote baseload generation</b>	Power at all hours	Long	High	Low
<b>Remote wind or solar</b>	Power at some hours	Long	High	Low
<b>Peaking resources</b>	Power in peak hours, plus reserves at all hours	Short	Low	Low
<b>Hydro</b>	Power at some or all hours	Long	High	Low
<b>Neighbor utilities</b>	Reserve sharing; energy trading	Short to long	Vary	Low
<b>Substations networked for reliability</b>	Power at some hours	Short	Medium	Low
<b>Storage and substations</b>	Power at peak hours, plus reserves at all hours	Very short	Very low	Low

In a low load factor system, these high loads will occur less frequently, and the heavy loading will not last as long. If the only high-demand hours were the 12 monthly peak hours, for example, most transformers would be retired for other reasons before they experienced significant damage from overloads. In this situation, larger losses of service life per overload would be acceptable, and the short peak would allow greater overloads for the same loss of service life.

With high load factors, there are many hours of the year when the transformers are at or near full loads. In this case, the transformer must be sized to limit overloads to acceptable levels and frequency of occurrence commensurate with a reasonable projected lifespan for the asset. If the transformer is often near full capacity with frequent overloads, it will fail more rapidly.

Transmission lines serve many purposes, including connecting remote generating plant to urban centers and enabling the optimal economic interchange of power between regions with different load patterns and generation options. Each transmission segment can be separately examined and allocated on a cost-reflective basis. Table 3 provides examples of this.

### 5.1.3 Distribution

The factors driving load-related distribution costs are similar to those for transmission. Different components are built and sized for different reasons; some serve the shared needs of hundreds or thousands of customers, while

other components are designed to serve a single customer. Substations and line transformers must be larger — or will wear out more rapidly — if they experience many high-load hours in the year and if daily load factors are high. Underground and overhead feeders are also subject to the effects of heat buildup from long hours of relatively high use.

The allowable load on distribution lines is determined by both thermal limits and allowable voltage drop. Higher loads on a primary feeder may require upgrades (raising the feeder voltage, adding a new feeder, reconductoring to a larger wire size, increasing supply from single-phase to three-phase) to maintain acceptable voltage at the end of the feeder. Small secondary customers can be farther from the line transformers than large customers (allowing the utility to use fewer transformers to serve the same load) and can be served with smaller conductors.

As with station transformers, line transformers can handle moderate overloads for relatively short periods of a few hours but will deteriorate quickly if subjected to extended overload conditions. Therefore, the sizing of transformers takes into consideration not only the maximum capacity required but also the underlying load shape. Figure 17 on the next page shows actual data from a confidential load research sample on a summer peak day for 10 residential customers who share a line transformer. Although no group of 10 customers is identical to any other group of 10 customers, this demonstrates how diversity determines the need for the sizing of system elements. Only three of the 10 customers peak at the



Figure 17. Summer peak day load from 10 residential customers on one line transformer

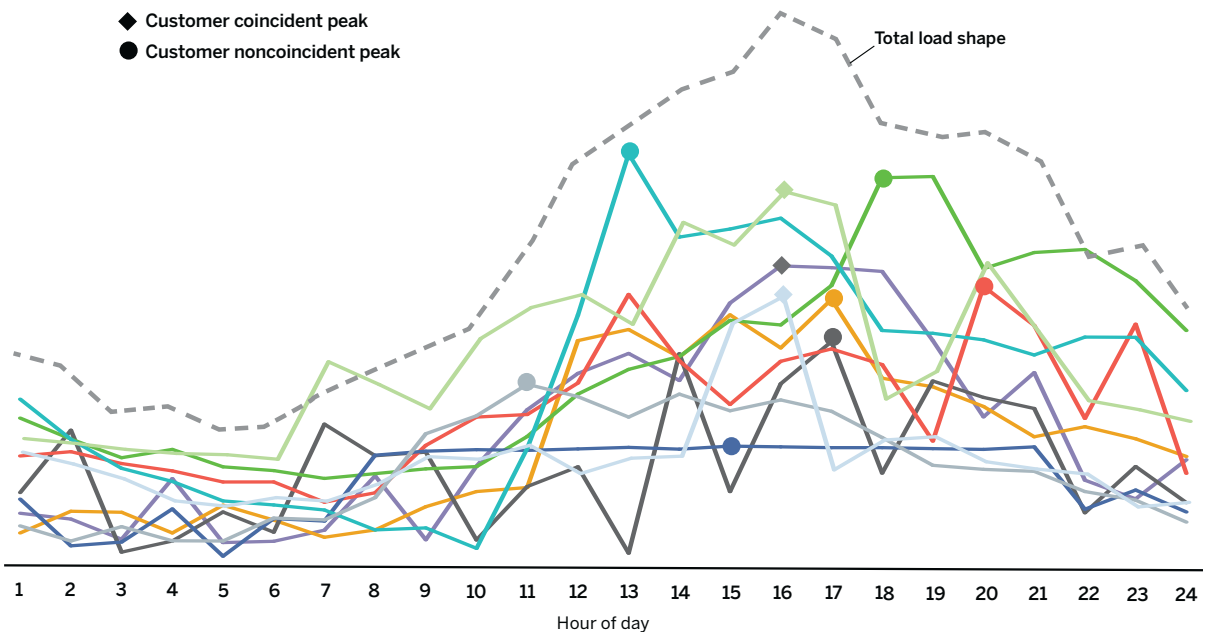

Source: Confidential load research sample

same time as the 4 p.m. coincident peak for the group, and the coincident peak is only 86% of the sum of the individual peaks on this day. Furthermore, although not shown in this figure, this coincident peak is only 64% of the sum of the annual non-coincident peaks for the individual customers. It is important to note that a group of 10 residential customers is often less diverse than the combined loads from multiple customer classes, which determine the need for substation and generation capacity upstream of the final line transformer.

It is important to note that the load exceeds 50 kVA for only three hours and is below 40 kVA for 18 hours of this summer peak day. Referring back to Figure 16, under these circumstances, a 50-kVA transformer would likely be adequate to serve this load, because the overload is for only a short period. By contrast, the sum of the maximum noncoincident peak loads of the 10 customers is more than 90 kVA.

A large portion of the distribution investment is driven primarily by the need to serve a geographical region. Once a decision is made to build a circuit, the **incremental cost** of

connecting additional customers consists mostly of additional line transformers (if the new customer is isolated from others) and secondary distribution lines. This is true even if those investments may serve multiple customers, particularly in urban and suburban areas. These shared facilities are largely justified by the total revenues of the customers served, not the peak load or number of customers. A particular transmission line, substation or feeder to serve an area could be justified by a single very large load, a small number of large customers or a large number of very small customers.

Nearly every electric utility has a line extension policy that sets forth the division of costs incurred to extend service to new customers. Typically, this policy provides for a certain amount of investment by the utility, with any additional investment paid for by the new customers. These provisions are intended to ensure that new customers pay the incremental cost of connecting them to the system without raising rates to other customers. For most utilities, there is no corresponding credit where new service has a cost that is lower than the

**Table 4. Cost drivers for distribution**

Type	Purpose	Investment-related costs	Maintenance costs
<b>Substations</b>	Power at all hours; capacity for high-load hours	High	Low
<b>Primary circuits</b>	Power at all hours; capacity for high-load hours	High	Low
<b>Line transformers</b>	Power at all hours; capacity for localized high-load hours	Medium	Low
<b>Secondary service lines</b>	Power at all hours; capacity for localized high-load hours	Medium	Low
<b>Meters: Traditional</b>	Measuring usage	Low	Low
<b>Meters: Advanced</b>	Multiple functions	Medium	Low

average embedded cost of service, a circumstance that results in benefits to the utility and other ratepayers.

The final components in the distribution system are meters, typically installed for all residential and general service customers but not for very predictable loads like traffic signals or streetlights. How to classify the cost is a matter of debate. On one hand, a meter is needed because usage levels vary from customer to customer and month to month, a theoretically usage-related cost. But on the other hand, one meter is needed for every metered customer, and meter costs do not typically vary from customer to customer within a class. In addition, **smart meters** entail both higher direct investment costs and back office investments but provide generation, transmission and distribution system benefits by allowing more precise measurement and control of local loads and more accurate assignment of peaking capacity requirements. Lastly, the cost of current transformers and potential transformers necessary to meter large customers should be included as part of their metering costs — an issue common between embedded and marginal cost methods.<sup>32</sup> Table 4 summarizes cost drivers in the distribution system.

#### 5.1.4 Incremental and Complementary Investments

Good economic analysis should distinguish properly between complementary or alternative investments, which substitute for one another, and incremental investments, which add costs to the system.

Customers receive service at different voltages and with

different types of equipment. Most of the distinctions among types of equipment represent alternative or complementary methods for providing the same service. For example, various primary distribution feeders operate at 4 kV, 13 kV or 25 kV and may be overhead or underground construction, depending on load density, age of the equipment, local governmental requirements and other considerations. Although the power flowing from generation to a customer served at 25 kV may not flow over any 4-kV feeder, the 4-kV feeders serve the same function as the 25-kV feeders and (in places in which they are adequate) at lower cost.<sup>33</sup> Serving some customers at 4 kV and spreading the feeder costs among all distribution customers does not increase costs allocated to the customers served directly from the 25-kV feeders; converting the 4-kV feeders to a higher voltage would likely increase costs to all distribution customers, including those now served at 25 kV. In this situation, all the feeders should be treated as serving a single function, and all their costs should be allocated in the same manner.

Similarly, most customers served by single-phase primary distribution are served with that configuration because it is cheaper than extending three-phase primary distribution, which they do not require because of the nature of their loads.

<sup>32</sup> Current transformers reduce the amperage so a meter can read it. Potential transformers reduce the voltage for meter reading (Flex-Core, n.d.).

<sup>33</sup> Conversely, the 4-kV supply to some customers is from transformers fed directly from transmission without using the 25-kV system.

On the other hand, some distinctions in voltage level represent incremental investment:

- Most customers served at distribution voltages cannot take service directly from the transmission system. Even if a transmission line runs right past a supermarket or housing development, the utility must run a feeder from a distribution substation to serve those customers. Distribution in its broadest sense is thus principally an incremental service, rather than an alternative to transmission, needed by and provided to some customers but not all.<sup>34</sup>
- Similarly, most customers who take service at secondary voltage have a primary line running by or to their premises yet cannot take service directly at primary voltage.<sup>35</sup> The line transformers are incremental equipment that would not be necessary if the customers could take service at primary voltage.<sup>36</sup>

These incremental costs should be functionalized so that they are allocated to the loads that cause them to be incurred, while each group of complementary costs (such as various distribution voltages) generally should be treated as a single function and recovered from all customers who use any of the alternative facilities.

In other situations, distinguishing between incremental and complementary costs can be more complicated. Examples include the treatment of transmission equipment at different voltages and the treatment of secondary poles. Many embedded cost of service studies treat subtransmission as an incremental cost separate from transmission and charge more for delivery to customer classes served directly from the subtransmission system or from substations fed by the subtransmission system. For the most part, utilities use lower transmission voltage where it is less expensive than higher voltages, either due to the lower cost of construction relative

to the total load that needs to be served by the line or the happenstance that the subtransmission line is already in place. If it is less expensive to serve customers with the lower voltage, it would be inequitable to charge them more for being served at that voltage.

Similarly, distribution poles carrying only secondary lines are less expensive than poles carrying primary lines. If a customer served by a secondary-only pole had to be served at primary voltage instead, the primary pole would be more expensive, and that higher cost would almost certainly be allocated to all distribution customers. Secondary poles (unlike line transformers and most secondary lines) are lower-cost alternatives to some primary poles.<sup>37</sup>

## 5.2 Determining Customer Classes

In addition to administrative simplicity, the purpose of separating customers into broad classes flows from the idea that different types of customers are responsible for different types of costs, and thus it is fairer and more efficient to charge them separate rates. One set of rates for each customer class, based on separate cost characteristics, is the key feature of postage stamp pricing for electric utilities. As a result, it is very important to determine appropriate customer classes with different cost characteristics at the outset of a cost of service study. The number of classes will vary from utility to utility and may vary depending on the costing methodology being used. In addition to equitable cost allocation, different rate structures are often used for different rate classes. For example, residential customer classes generally do not have demand charges today, but most large industrial classes do. This means that decisions regarding the number and type of customer classes can also have rate design implications,

34 In some cases, a distribution substation and feeder can bring service to customers that would otherwise be served by an extension of the transmission system at higher cost. Identifying and accounting for that limited complementary service is probably not warranted in most embedded cost of service study applications.

35 Another way of looking at this relationship is that secondary customers are those for whom providing service at secondary has a lower total cost than providing service at primary. Sharing utility-owned transformer capacity is less expensive than having each customer build its own transformer. See Chapter 11 for a discussion of primary and secondary distribution and their allocation.

36 Although most networked secondary conductors parallel primary lines and are incremental to the primary system, a limited number of secondary conductors extending beyond the primary lines are complementary, because they avoid the need to extend primary lines.

37 Similarly, a portion of the secondary lines replaces primary lines. If the customers that can be served with secondary poles required primary service, the utility would need to extend the primary lines rather than secondary lines. Hence, a portion of the secondary lines is also complementary to the primary system, rather than additive.

although this is not necessarily permanent.

Most utilities distinguish among residential customers, small commercial customers, large commercial customers, industrial customers and street lighting customers. The commercial and industrial classes often are collectively termed general service rate classes. In many cases, general service customers are categorized by voltage levels. Customers served at primary distribution voltage generally do not use, and should not be allocated, costs of secondary distribution facilities, and customers served at transmission voltage generally do not use, and should not be allocated, costs of distribution facilities. Many utilities also separate general service classes with even greater granularity than using simple voltage criteria.

One area where utility practices can vary significantly is whether there is more than one residential class or, alternatively, multiple residential subclasses. Some utilities separate out residential customers based on a measure of size, such as peak demand or energy use. This can be significant in jurisdictions that categorize farms or large master-metered multifamily buildings as residential in a formal sense. Some jurisdictions also create separate classes based on the usage of specific technologies like electric resistance heating. In some jurisdictions, low-income discount customers are treated as a separate rate class.

The creation of multiple residential classes or subclasses is typically justified on cost grounds. There are inarguably many cost distinctions among different types of residential customers, and simple postage stamp cost allocation and rate structures may not capture many of those distinctions. Regulators and utilities have long analyzed the causes of such differences, which vary widely across the country. Some of the distinctions are based on technology (or, more accurately, as a proxy for the load impacts of certain technologies), such as electric space heating, electric water heating, solar or other distributed generation and even electric vehicles. Other distinctions are based on the characteristics of service. Those with relatively large impacts on cost allocation include:

- Single family versus multifamily.
- Urban (multiple customers per transformer) versus rural (one customer per transformer).
- Overhead service versus underground service.

A word of caution is appropriate here. With respect to technology-driven class characteristics such as electric space heat, water heat, vehicles or solar installations, singling out customers based on technology adoption has serious practical and theoretical downsides. Furthermore, addressing one minor cost distinction is likely not fair or efficient if several other major cost distinctions, such as those listed above, are not addressed. It is wiser to consider multiple customer and service characteristics simultaneously to create technology-neutral subclasses for both cost allocation and rate design purposes.

To begin, electric space heating customers are likely to have different load characteristics from the nonheating customers, with significantly more usage and a different daily load shape in the winter. For a winter-peaking system, this could mean that electric heating customers should be allocated proportionately more costs. Conversely, in a summer-peaking system, electric heating customers should be allocated proportionately fewer overall costs. However, this issue, which is essentially a question of a potential intraclass cross-subsidy between types of residential customers, can also be addressed through changes to rate design. Seasonally differentiated rates, if based appropriately on cost causation, can achieve the same distributional impact as separate rate classes for heating and nonheating customers while bringing additional benefits from the improved efficiency of pricing.

The creation of an electric heating rate class can have other implications. In regions where electric heating customers are disproportionately low-income, this decision also has significant equity implications. There can also be environmental repercussions to this choice. Concerns would arise, for example, if electric heating rates promote use of gas and coal in power plants to replace direct burning of gas on-site for heating, which historically was often more efficient on a total energy basis. Recent developments in efficient electric heating, particularly air and ground source heat pumps, may have switched the valence of these questions. In certain areas, higher-income customers may be disproportionately adopting efficient electric heating. And the new electric technologies may now be significantly cleaner and more efficient than on-site combustion of natural gas, particularly if powered by

zero emissions electric resources. A seasonal and time-varying cost study and time-varying rates may enable appropriate cost recovery without need for a separate class.

Several states have considered creating a separate rate class for customers with solar PV systems. Because solar customers may have different usage patterns than other customers, this is reasonable to investigate. However, it is not clear that there is a significant cross-subsidy to address, particularly at low levels of PV adoption. Current rate design practices for solar customers in many jurisdictions — such as net metering using **flat volumetric rates**, monthly netting and crediting at the retail rate — are fairly simple. These rate design practices could be improved significantly over time and integrated with broader rate design reforms. For example, a time-varying cost study would allow the creation of more granular time-varying rates so that solar customers pay an appropriate price for power received during nonsolar hours and are credited with an appropriate price for power delivered to the distribution system during solar hours. This would include changes to netting periods, which would reveal more information about how a solar customer actually uses the electric system.

In terms of rate classes for specific technologies, some utilities separate out customers with electric water heating as a proxy for a flat load shape and the potential for load control. In the future, some utilities may seek to make electric vehicle adoption a separate rate class as a substantially controllable load with distinct usage characteristics. However, these technologies may not need consideration as a separate rate class, particularly given efforts to improve the cost causation basis of rate design more generally. Again, time-varying rates will appropriately charge customers with peak-oriented loads and appropriately benefit customers with loads concentrated in low-cost hours or controlled into those hours.

Some utilities have implemented separate rate classes

for single-family and multifamily residential customers. There are many reasons to believe that the cost of serving multifamily buildings is substantially lower than serving single-family homes on average:

- Shared service drops.
- Increased diversity of load for line transformers and secondary distribution lines, enabling more efficient sizing.
- Reduced cost of distribution per customer, since no distribution lines are required between customers in the building.<sup>38</sup>
- Reduced coincidence with both summer and winter peak loads because common walls reduce space conditioning use relative to single-family units of the same square footage, and because lighting and baseload appliances such as refrigerators and water heaters (if electric) are a larger percentage of loads for units with fewer square feet.
- Reduced need for secondary distribution lines in cases where the multifamily building can be served directly from the transformer.
- Reduced summer peak coincidence if space cooling is provided through a separate commercial account for the building, rather than as part of the individual residential accounts.
- Reduced costs of manual meter reading, where still applicable.

There may be countervailing considerations in some service territories, such as if multifamily buildings are served by more expensive underground service and single-family buildings are served with cheaper overhead lines. A similar set of considerations may cause some utilities to disaggregate customers by geography, such as those residing inside and outside city limits.<sup>39</sup> Customers in deeply rural areas tend to be more expensive to serve, since they typically are too far from their neighbors to share transformers, require a long run of primary line along the public way, and generally

<sup>38</sup> This distinction is important where some distribution costs are classified as customer-related. In those situations, each multifamily building (rather than each meter) should be treated as one customer, as would a single commercial customer of the same size and load.

<sup>39</sup> For example, Seattle City Light, a municipal utility, has two rate schedules for most commercial and industrial classes within the city: one for the highly networked higher-cost underground system in the urban core,

and another for the balance of the city, plus separate higher rates for the adjacent cities and towns where it provides service. Compare Schedules MDC, MDD, MDS and MDT at Seattle City Light (n.d.). The city of Austin, Texas, also applies different rates to customers outside the city limits (Austin Energy, 2017). In many places, cities impose franchise fees or municipal taxes that make customer bills inside cities higher than those outside cities, even though the cost data may suggest the opposite is more equitable.

have higher unit costs related to lower load per mile of distribution line.<sup>40</sup>

Analysts may want to employ a simple standard for deciding when to divide a subclass for analytical purposes, based on whether the groups are large enough and distinct enough to form a separate class or subclass. One such guideline might be that, if more than 5% of customers or 5% of sales within a class have distinct cost characteristics, differentiation is worth considering. If fewer than that, although the per-customer cost shifts may be significant, the overall impact on other customers will likely be immaterial. If 2% of the load in a class is paying 20% too much or too little, for example, other customers' bills will change only 0.4%. But if 15% of the load is 20% more or less expensive, the impact on other users rises to 3%. The trajectory of these impacts over time can also be relevant.

Although improved distributional equity from additional rate classes is a laudable goal, and indeed advances the primary goal of cost allocation, there are countervailing considerations that may dictate keeping the number of rate classes on the smaller side. First, there are administrative and substantive concerns around adding rate classes, both in litigation at state regulatory commissions and in real-world implementation. Some potential distinctions among customers may be difficult to implement because they involve subjective and potentially controversial determinations by on-the-ground utility personnel. In creating new distinctions, regulators, utilities and stakeholders must all have confidence that there are true cost differentials between the customer types and that there will be little controversy in the application of the differentials. Some analysts object to customer classes based on adoption of particular end uses, although this may serve as a proxy for significantly different usage profiles. Furthermore, some utilities and parties in a rate case may propose rate classes that effectively allow undue discrimination. If the proper data aren't available to scrutinize such claims, either publicly or for parties in a rate case, then this may allow an end-run around one of the significant motivations for postage stamp pricing: preventing price discrimination.

Lastly, as described above for electric heating and solar PV customers, rate design changes can also address certain

cross-subsidies within customer classes in a relatively straightforward manner that also provides additional efficiency benefits. In principle, perfectly designed time- and location-varying pricing for all electric system components and externalities, applied identically to all customers, could eliminate the need for customer classes and cost allocation entirely while providing perfectly efficient price signals. This is unlikely to be the case for the foreseeable future but illustrates the conceptual point that an efficient improvement to rate design may be a strictly preferred option compared with the creation of a new rate class. For example, certain types of customers could be put on technology-neutral time-varying rates on an opt-out or mandatory basis, such as customers with storage, electric vehicles or distributed generation.

### 5.3 Load Research and Data Collection

Any cost of service study, as well as rate design, load forecasting, system planning and other utility functions, depends heavily on load research data. Cost allocation, in particular, requires reasonably accurate estimates for each class or group distinguished in the analysis, the number of customers, their energy usage (annual, monthly and sometimes more granular time periods), their kW demand at various times and under various conditions, and sometimes more technical measures such as **power factor**. The key principle is that there is diversity among customers in each class, meaning the consumption characteristics for the group are less erratic than those of any individual customer. Load research is the process of estimating that diversity.

At the very least, these data must be available by class across the entire system. For some applications, these data are useful and even essential at a more granular level, such as for each substation, feeder or even customer. Ideally, the cost of service study would be able to draw on information about the hourly energy usage by class, as well as the contribution of each class to the sum of the customer contributions to the maximum loads across the line transformers serving the

---

<sup>40</sup> These factors may be offset by the utility's policy for charging new customers for extending the distribution system, as discussed in Section 11.2

class, the feeders serving the class, the substations serving the class and so on. Modern AMI and advanced distribution monitoring systems, if properly configured, can provide those data. Some utilities now routinely collect interval load data at each level of the system, while others are starting to acquire those capabilities.

The data needed for different cost allocation frameworks and methods can vary greatly, and it is difficult to generalize because of this. But at a high level, embedded cost techniques rely on one year of data or the equivalent forecast for one year. For many inputs, marginal cost techniques often rely on multiple years of data in order to estimate how costs are changing with respect to different factors over time. Different data may be needed for each step of the process, starting from the functionalization of costs down to the creation of **allocation factors**, or allocators, to split up the costs to customer classes.

Where the utility's metering and data collection do not directly provide comprehensive load data for all customers and system components, two options are available. The first and generally preferable option is sampling. Most investor-owned and larger consumer-owned utilities install **interval meters** specifically for load research purposes on a sample of customers in each class that does not have widespread interval metering.<sup>41</sup> The number and distribution of those meters should be determined to provide a representative mix of customer loads within the class (or other subgroups of interest) and to produce estimates of critical values (such as contribution to the monthly system peak load) that reach target levels of statistical significance.<sup>42</sup> These samples are typically a few hundred per class in order to meet the PURPA standard. Second, some smaller utilities borrow "proxy data" from a nearby utility with similar customer characteristics and more robust load research capabilities. Class load data

are usually publicly available for regulated utilities. Neither sampled load nor proxy load will provide the precision of comprehensive interval metering, but they can provide reasonable estimates of the contribution of the group to demand at each hour, enabling development of cutting-edge techniques such as time-specific allocation methods.

Different elements of load research data are relevant in the creation of allocation factors for different parts of the system. For example:

- Most residential customers may be served through a transformer shared with other residential, commercial and street lighting customers, so the allocation of transformer costs to each class should ideally be derived from their contribution to the high-load periods of each such transformer.
- Some residential customers are served from feeders that peak in the morning and others from feeders that peak in midday or the evening; some of those feeders may reach their maximum load or stress in the summer and others in the winter. The sum of the class contribution to the various peak hours of the various feeders determines the share of peak-related costs allocated to the class for this portion of the distribution system.
- At the bulk power level, all customers share the generation and transmission system, and the diversity of all usage should be reflected, whether at the highest system hour of the year (a method known as 1 CP, for coincident peak), the highest hour of each month (12 CP) or the highest 200 hours of the year (200 CP), all **on-peak** hours, **midpeak** hours and off-peak hours, or any other criteria relevant for allocation.

Table 5 on the next page shows illustrative load research data for four customer classes. For the purposes of clear examples throughout the manual, we adopt the convention

41 Utilities usually have interval meters on customers over some consumption threshold for billing purposes. Smaller customers may have meters that record only total energy consumption over the billing period (typically a month), or both monthly energy and maximum hourly (or 15-minute) demand, neither of which provides any useful data for allocating time-dependent costs.

42 In 1979, FERC issued regulations to implement PURPA § 133 (16 U.S.C. § 2643), which requires the gathering of information on the cost of service.

C.F.R. Title 18, Chapter 1, Subchapter K, Part 290.403(b) established the requirement, since repealed, that "the sampling method and procedures for collecting, processing, and analyzing the sample loads, taken together, shall be designed so as to provide reasonably accurate data consistent with available technology and equipment. An accuracy of plus or minus 10 percent at the 90 percent confidence level shall be used as a target for the measurement of group loads at the time of system and customer group peaks." See Federal Energy Regulatory Commission Order 48 (1979).

Table 5. Illustrative load research data

	Residential	Secondary commercial	Primary industrial	Street lighting	Total	Used for	
<b>Energy metrics (MWhs)</b>							
Total	1,000,000	1,000,000	1,000,000	100,000	3,100,000	All energy-related costs, including generation, transmission, primary distribution	
Total secondary	1,000,000	1,000,000	N/A	100,000	2,100,000		
Energy by time period							
Summer	600,000	650,000	500,000	30,000	1,780,000		
Winter	400,000	350,000	500,000	70,000	1,320,000		
Daytime	600,000	700,000	500,000	0	1,800,000		
Off-peak	400,000	350,000	500,000	90,000	1,340,000		
Midpeak	550,000	600,000	470,000	9,000	1,629,000		
Critical peak	50,000	50,000	30,000	1,000	131,000		
<b>Customer metrics</b>							
Line transformers used	20,000	10,000	N/A	20,000	50,000	Transformers, services	
Customers	100,000	20,000	2,000	50,000	172,000	Billing	
<b>Demand metrics (MWs)</b>							
Sum of customer NCP	2,000	1,000	N/A	100	3,100	Input to line transformers	
Class NCP: circuit	400	400	250	100	1,150	Primary distribution	
Class NCP: substation	300	300	225	100	925	Substations	
System 1 CP	250	300	200	0	750	Transmission, generation	
System monthly 12 CP	225	250	175	10	660		
System 200 CP	200	240	150	10	600		

of a commercial customer class of all general service customers served at secondary voltage, labeled as “Secondary commercial,” and an industrial customer class of all general service customers served at primary voltage, labeled as “Primary industrial.”

In this illustration, the sum of individual customer noncoincident peak demands is 3,100 MWs, excluding the primary industrial class that is not shown in the table.<sup>43</sup> However, the coincident peak demand served by the utility becomes more diverse as we move up the system, a phenomenon described in more detail in Section 5.1. As a result, the observed coincident peak demands are lower at more broadly shared portions of the system. At the highest level, this illustrative system has a 750-MW coincident peak demand for the highest single hour, labeled as “System 1 CP.” In between, the sum of the class NCPs at the circuit level, labeled as “Class NCP: circuit,” is 1,150 MWs, and the sum of the class NCPs at the substation level, labeled as “Class NCP: substation,” is 925 MWs. Customers served at primary

voltage (primary industrial) have no utility-provided line transformers, and the first level at which their demand is typically relevant is the circuit level.

The street lighting class is important to note with respect to the volatility of results. Because this class has zero daytime usage and a very different (typically completely stable overnight) load profile than other classes, it is highly affected by the choice between noncoincident methods and either coincident or hourly methods. In addition, because streetlights represent many points of delivery but are typically located only in places where other customers are nearby, this class almost never “causes” the installation of a transformer or the creation of a secondary delivery point but also does account for a huge number of the individual points of use

<sup>43</sup> In Table 5, the sum of customer NCPs for the primary industrial class is shown as “N/A” because these customers do not use line transformers and thus this demand metric is not generally relevant to this class. For more general purposes, we are assuming that the sum of customer NCPs for the primary industrial class in this illustration is 300 MWs, bringing the overall total to 3,400 MWs.



**Table 6. Simple allocation factors derived from illustrative load research data**

	Residential	Secondary commercial	Primary industrial	Street lighting	Used for
<b>Energy metrics (MWhs)</b>					
Total	32%	32%	32%	3%	All energy-related costs, including generation, transmission, distribution
Total secondary	48%	48%	N/A	5%	
Energy by time period					
Summer	34%	37%	28%	2%	
Winter	30%	27%	38%	5%	
Daytime	33%	39%	28%	0%	
Off-peak	30%	26%	37%	7%	
Midpeak	34%	37%	29%	1%	
Critical peak	38%	38%	23%	1%	
<b>Customer metrics</b>					
Line transformers used	40%	20%	N/A	40%	Transformers, services
Customers	79%	17%	3%	1%	Billing
<b>Demand metrics (MWs)</b>					
Sum of customer NCP	65%	32%	N/A	3%	Input to line transformers
Class NCP: circuit	35%	35%	22%	9%	Primary distribution (legacy) Substations
Class NCP: substation	32%	32%	24%	11%	
System 1 CP	33%	40%	27%	0%	Transmission, generation
System monthly 12 CP	34%	38%	27%	2%	
System 200 CP	33%	40%	25%	2%	

Note: Class percentages may not add up to 100 because of rounding.

on the system. Put another way, we all like streetlights near our homes and businesses, but nearly all of them go in as a secondary effect of residential or commercial development; a few are along major highways without a nearby residence or business, but these are rare.

The next step is generating allocation factors to be used in the allocation phase of the cost study. For embedded cost studies, these are applied to the total investment and expense by FERC account, while in marginal cost studies they are applied to the calculated unit costs for each type of system component.

Table 6 shows the data above converted to allocation factors. The only implicit assumption is that the circuit-level peak demand for the residential class is one-fourth of the customer NCP demand due to load diversity and that for the commercial class it is one-half, reflecting lower diversity of commercial customer usage across the day compared with residential load. The raw factors are computed simply by dividing each class contribution to each category by the

system total, then converting to percentages. For embedded cost of service studies, this manual recommends the use of class hourly energy use as a common allocation factor for all shared system components in generation, transmission and distribution where the system is made up of components essential for service at any hour, but sized for maximum levels of usage, and where the class contribution to that usage varies. The only one of these factors that is not self-explanatory is the midpeak factor, which takes both on-peak and **critical peak** usage into account, reflecting class usage in all higher-cost hours. This is illustrative of the probability-of-dispatch method, in which the likelihood of any resource being dispatched at specified hours is measured. There is no diversity of street lighting usage in this example, but little or no demand imposed at the system peak hours. Customer weighting factors are typically based on the relative cost of meters and billing services for different types of customers, based on complexity.

**Table 7. Composite allocation factors derived from illustrative load research data**

Method	Components	Residential	Secondary commercial	Primary industrial	Street lighting	Used for
<b>Equivalent peaker</b>	20% system 200 CP/ 80% energy	32%	34%	31%	3%	Generation, transmission
<b>On-peak</b>	50% midpeak/ 50% critical peak	36%	38%	26%	1%	Peaking generation
<b>Average and peak</b>	50% class NCP/ 50% energy	34%	34%	27%	6%	Primary distribution
<b>Minimum system</b>	50% customer/ 50% class NCP: circuit	57%	26%	12%	5%	Circuits (legacy)
<b>Equivalent peaker for transformers</b>	20% delivery points/ 80% customer NCP	60%	30%	0%	11%	Line transformers and secondary service lines

Note: Class percentages may not add up to 100 because of rounding.

In Table 6, we have calculated allocation factors shown as a class percentage of each usage metric. In Part II, we discuss in what circumstances each of these will be appropriate for embedded cost of service studies. In many cases, weighted combinations of these are appropriate. Several commonly used composite allocation factors are shown in Table 7, computed by weighting values in Table 6.

Given the wide diversity of utilities and their load patterns, readers should be careful about overgeneralizing from these illustrative examples. However, some patterns will hold true across the board. For example, the minimum system method will always allocate more costs to classes with large numbers of customers, at least compared with the basic customer method.

## 6. Basic Frameworks for Cost Allocation

**W**e group cost allocation studies into two primary families. Embedded cost studies look at existing costs making up the existing revenue requirement. Marginal cost studies look at changes in cost that will be driven by changes in customer requirements over a reasonable planning period of perhaps five to 20 years. In the same family as marginal cost studies, total service long-run incremental cost (TSLRIC) studies look at the cost of creating a new system to provide today's needs using today's technologies, optimized to today's needs. Each has a relevant role in determining the optimal allocation of costs, and regulators may want to consider more than one type of study when making allocation decisions for major utilities that affect millions of consumers.

### 6.1 Embedded Cost of Service Studies

Embedded cost of service studies may be the most common form of utility cost allocation study, often termed “fully allocated cost of service studies.” Most state regulators require them, and nearly all self-regulated utilities rely on embedded cost of service studies. The distinctive feature of these studies is that they are focused on the cost of service and usage patterns in a test year, typically either immediately before the filing of the rate case or the future year that begins when new rates are scheduled to take effect. This means there is very little that accounts for changes over time, so it is primarily a static snapshot approach. Embedded cost of service studies are also closely linked to the revenue requirement approved in a rate case, which can be administratively convenient.

Generally speaking, in the traditional model displayed in Figure 18 on the next page, functionalization identifies the purpose served by each cost (or the underlying equipment or activity), classification identifies the general category of factors that drive the need for the cost, and allocation selects the parameter to be used in allocating the cost among classes.<sup>44</sup>

Although they are convenient parts of organizing a cost of service study, functionalization and classification decisions are not necessarily critical to the final class cost allocations. The cost of service study can get to the same final allocation in several ways. For example, consider the reality that a portion of transmission costs is driven by the need to interconnect remote generation to avoid fuel costs. This can be reflected by functionalizing a portion of transmission cost as generation, or by classifying a portion of transmission in the same manner as the remote generation, or it can be recognized by using a systemwide transmission allocator with some energy component. In either case, a portion of costs is allocated based on energy throughput, not solely on design capacity or actual capacity utilization.

#### 6.1.1 Functionalization

In this first step, cost of service studies divide the utility's accounting costs into a handful of top-level functions that mirror the elements of the electric system. At a minimum, this includes three functions:<sup>45</sup>

- **Generation:**<sup>46</sup> the power plants and supporting equipment, such as fuel supply and interconnections, as well as purchased power.
- **Transmission:** high-voltage lines (which may range from 50 kV to over 300 kV) and the substations connecting

<sup>44</sup> The third step is usually called allocation, which is the same as the name of the entire process. This step involves the selection or development of allocation factors. Some analysts refer to this third step as factor allocation to prevent confusion.

<sup>45</sup> Some of the costs, such as for energy efficiency programs and advanced

meters, may serve multiple functions and must be assigned among those functions or treated as special functional categories.

<sup>46</sup> Some sources use the term “production” instead. This manual uses the term “generation” and generally includes exports from storage facilities under this category.

Figure 18. Traditional embedded cost of service study flowchart

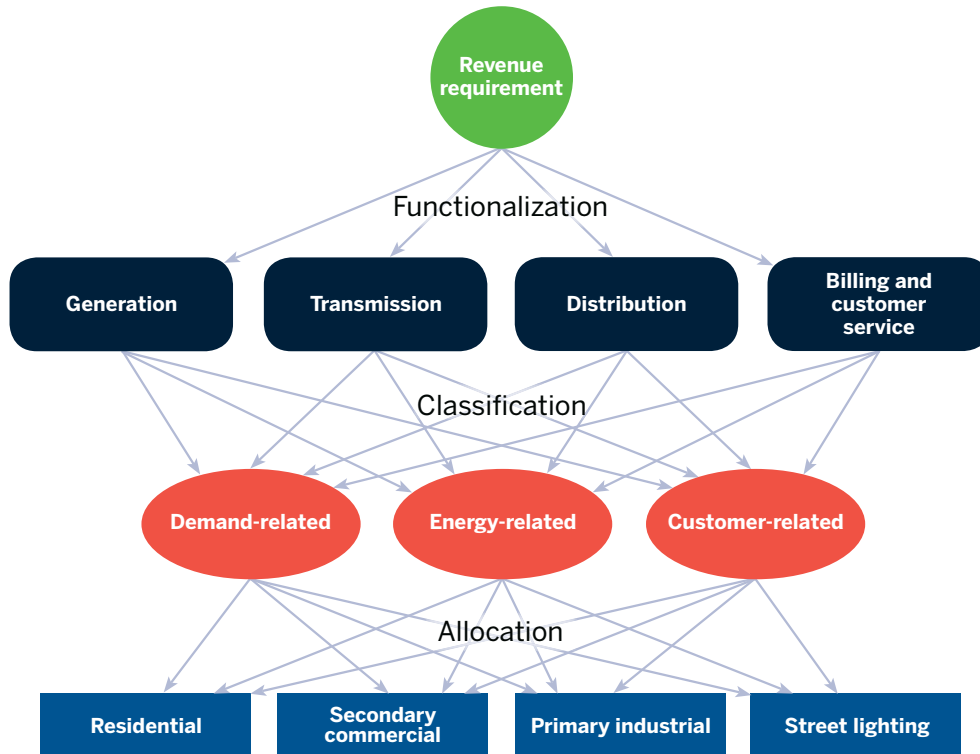

those lines, moving bulk power from generation to the distribution system.

- **Distribution:** lower-voltage primary feeders (in older systems, 4 kV and 8 kV; in newer areas, typically 13 kV to 34 kV) that run for many miles, mostly along roadways, and the distribution substations that step power down to distribution voltages; line transformers that step the primary voltages down to secondary voltages (mostly 120 V and 240 V); and the secondary lines that connect the transformers to some customers' service drops.

Although some utility analysts combine all costs into these three functions, the better practice is to include other functions as well at this stage:

- **Billing and customer service:** Also known as retail service or erroneously labeled entirely as customer-related costs, these are directly related to connecting customers (service drops, traditional meters) and interacting with

them (meter reading, billing, communicating).

- **General plant and administrative and general expenses:** Overhead investments and expenses that jointly serve multiple functions (e.g., administration, financial, legal services, procurement, public relations, human resources, regulatory, information technology, and office buildings and equipment) can be kept separate at this stage. In some circumstances, these costs could be attributed to certain functions but are not tracked that way in a utility's system of accounts.
- **Public policy program costs:** In many jurisdictions, these costs are administered and allocated through another process; but if handled in a rate case, energy efficiency and other public policy programs should be tracked separately. Historically, in most cases functionalization decisions can follow the utility's accounting and are noncontroversial.

The investment that is booked as generation units is usually part of the generation function. But there are exceptions. In some situations, the function of an investment may not match the accounting category. Examples include the following:

- Transmission lines and substations that are dedicated to connecting specific generating plants to the bulk transmission network. These assets are often in the accounting records as transmission but are more properly functionalized as generation.
- Substations that contain switching equipment to connect transmission lines of the same voltage to one another, high-voltage transformers that connect transmission lines of different voltages, and lower-voltage transformers that connect transmission to distribution. These facilities may be carried in the accounting records as entirely transmission or entirely distribution but are properly split between transmission and distribution in the functionalization process.
- Equipment within transmission substations that look like distribution equipment (e.g., poles, line transformers, secondary conductors, lighting). These might be booked in distribution accounts but are functionally part of the transmission substation.

In addition, many cost of service studies subfunctionalize some costs within a function, such as the following:

#### *Generation*

- Differentiating baseload generation (which runs whenever it is available or nearly so), intermediate generation (which typically runs several hours daily) and **peaking generation** (which runs only in a few high-load hours and when other generation is unavailable).
- Separating generators by technology to recognize such factors as renewable resources procured to meet energy-based environmental goals, the differing reliability contributions per installed kW of various technologies (e.g., wind, solar, thermal) and the differences in cost structure and output pattern between thermal, wind, solar and hydro resources.

#### *Transmission*

- Categorizing lines (and associated substations) by their

role in operations, such as networking together the utility's service territory, providing radial supply to scattered distribution substations or importing low-cost baseload energy from distant suppliers.

- Segregating lower-voltage subtransmission facilities (typically under 100 kV) from higher-voltage facilities.
- Treating interconnections differently from the internal transmission network.
- Separating substations from lines.

#### *Distribution*

- Separating substations, lines (comprising overhead poles, underground conduit and the wires) and line transformers.
- Segregating costs of system monitoring, control and optimization related to reducing losses, improving **power quality** and integrating distributed renewables and storage.
- Dividing lines into primary and secondary components.
- In some cases, separating underground from overhead lines.

#### *Billing and customer service*

- Subfunctionalizing meters, services, meter reading, billing, customer service and other components, each of which may be allocated separately.
- Separating meters by technology — traditional kWh meters, **demand meters**, remotely read meters and advanced meters with hourly load recording and other capabilities — with different costs and different functions (including, for the advanced meters, services to the entire system).

#### *General plant and administrative and general expenses*

- Subfunctionalizing by type of cost: pensions and benefits, property insurance, legal, regulatory, administration, buildings, office equipment and so on.

In the future, organizing costs by function probably will still be helpful in organizing thinking about cost causation, but the cost of service study may need to differentiate functions in new ways. For example, distributed generation, storage, energy efficiency, demand response and smart grid technologies can provide services that span generation, transmission and distribution.

## 6.1.2 Classification

The second step of the process classifies each function or subfunction (i.e., each type of plant and expense) as being caused by one or more categories of factors. In particular, most cost of service studies use the classification categories of demand (meaning some measure of loads in peak hours or other hours that contribute to stressing system reliability or increasing capacity requirements on the generation, transmission or distribution systems), energy and customer number, and some use other categories (e.g., direct assignment, such as of street lighting).

The classification of most costs as demand-, energy- or customer-related dates back many decades. These categories can still be used but need to be interpreted more carefully as the utility system has changed in many ways:

- Utility planning has become more sophisticated.
- Utilities have access to more granular and comprehensive data on load and equipment condition.
- The variety of generation resources has increased to include wind, solar and other renewables with performance characteristics very different from legacy thermal and hydro resources.
- Multiple storage technologies are affecting generation, transmission and distribution costs.
- Legacy hydro, nuclear and fossil resources continue to operate and provide benefits to the utility system, but new similar resources and even continued operation of some existing units may no longer be cost-effective. Until they are retired, all or a portion of costs will remain in the allocation study.
- Demand response programs have increased in scale, role and variety.
- Utility spending on energy efficiency programs has increased.
- Advanced metering technology has added system benefits to a traditionally customer-related asset.

The demand and energy classifications are often treated as totally separate but, as discussed in Chapter 5, the load in many hours contributes to needs that have traditionally been classified to demand, and some hours are

**Table 8. 1992 NARUC cost allocation manual classification**

Cost function	Typical cost classification
<b>Production</b>	Demand-related Energy-related
<b>Transmission</b>	Demand-related Energy-related
<b>Distribution</b>	Demand-related Energy-related Customer-related
<b>Customer service</b>	Customer-related Demand-related

Source: National Association of Regulatory Utility Commissioners. (1992). *Electric Utility Cost Allocation Manual*

more important than others in driving energy costs. With improved information about class loads, and with a range of new technologies, it may be appropriate to move past the traditional energy and demand classifications and create new more granular distinctions, as discussed further in Chapter 17.

Table 8 reproduces a table from the 1992 NARUC *Electric Utility Cost Allocation Manual*, showing how the classification step worked in that period (p. 21).

This was a simplification even at the time, and changes to the industry and in the available data and analytical techniques merit reevaluation and reform. For example, a legacy framework for variable renewable capacity, particularly wind and solar, could treat the investment for utility-owned resources as 100% demand-related, since there are no variable fuel costs. However, power purchase agreements for these same resources are typically priced on a per-kWh basis from independent power producers. This could lead to two different approaches for the same asset depending on the ownership model, an obvious error in analysis that should be avoided by considering the actual products and services being provided. In addition, most of the benefits of wind and solar do not necessarily accrue at peak hours — the underlying justification of a demand-related classification. Similarly, analog meters were only useful for measuring customer usage and billing, but new AMI provides data that can be used for system planning and provides new opportunities for energy management and peak load reduction.

### 6.1.3 Allocation

The final step of the standard allocation process is the application of an allocation factor, or allocator, to each cost category.<sup>47</sup> An allocator is a percentage breakdown of the selected cost driver among classes. Within each broad type of classification, utilities use multiple allocators for various cost categories. For example, many different measures of “demand” are used to allocate demand-related costs, including various measures of contribution to coincident peaks (a single annual system coincident peak, or 1 CP); the average of several high-load monthly coincident peaks (e.g., 3 CP or 4 CP); the average of all 12 monthly coincident peak contributions (12 CP); the average of class contribution to some number of high-load hours (e.g., 200 CP); or different measurements of class maximum load (class

noncoincident peak) at any time during the year. Usage of these peak-based demand allocators is often referred to as the **peak responsibility method**.

Generation allocators are sometimes differentiated among resources, to reflect the usage of different types of capacity and to retain the benefit of legacy resources for historic loads. Customer allocators are often weighted by the average cost of providing the service to customers in the various classes so that the cost of customer relations, for example, may be allocated with a weight of 1 for residential customers, 2 for small commercial, 5 for medium commercial and 20 for industrial.

Other costs, such as A&G expenses, are sometimes allocated on the basis of a labor allocator where the classification and allocation of underlying labor costs for the

Figure 19. Modern embedded cost of service study flowchart

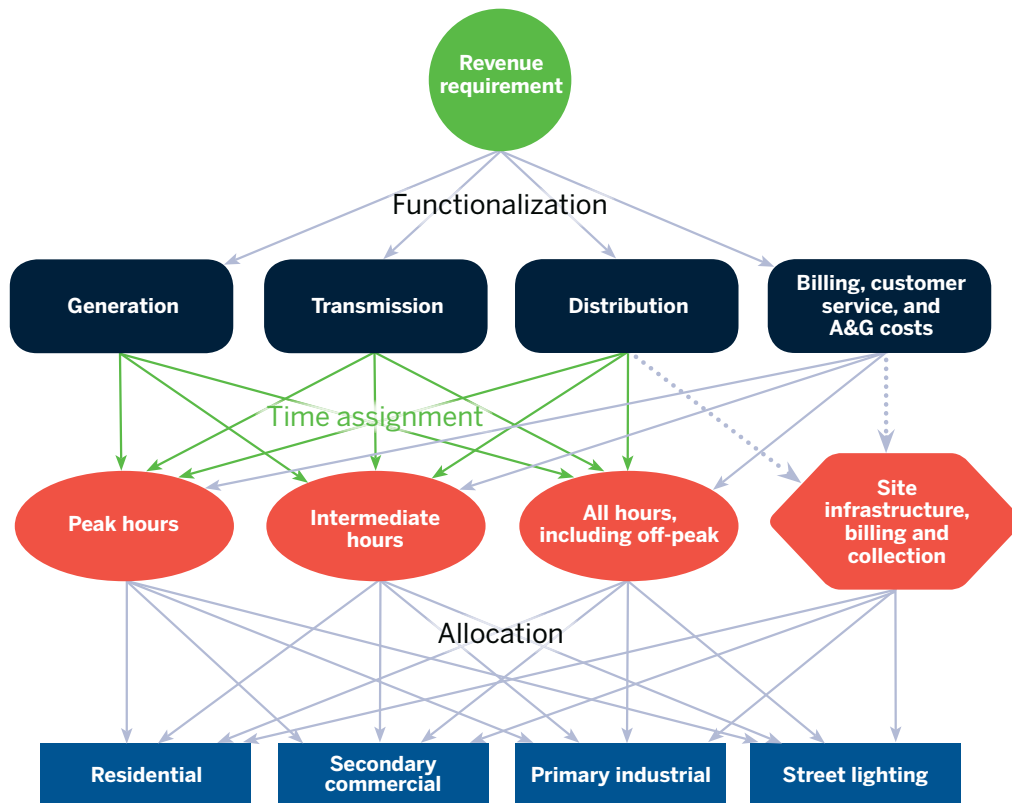

<sup>47</sup> Note that “allocation” is the term normally used for the entire process of assigning revenue requirements to classes and is also the term used for the last step of that process.

system is used for a set of other purposes. This is sometimes referred to as an internal allocator because it comes internally from previous calculations in the process. This is in contrast with “external allocators” based on facts and calculations outside of the cost allocation process, such as system peak and energy usage. Lastly, a variety of costs may be allocated based on a revenue allocator, which is based on the division of costs across all the classes.

### 6.1.4 Potential for Reform

As hourly data become available for all parts of the system, from transmission lines and substations through distribution feeders and line transformers to individual customers, an additional approach to classification and allocation becomes feasible: assigning costs directly to the time periods or operating conditions in which they are **used and useful**. This

approach may entirely bypass the traditional classification step, at least between energy and demand.<sup>48</sup> Some relatively recent approaches recognize the complexity of cost drivers and combine classification and allocation into time-varying direct assignment of costs, as explained in Part II.

These time-varying allocation methods are discussed in Chapter 17 and Section 9.2; Figure 19 shows a simplified version.

Table 9 shows a simplified allocation study (very few cost categories and only two customer classes) and a caricature of the effect of using very different approaches. Both are embedded cost studies, but they produce dramatically different results.

The first study uses what might have passed for a reasonable cost allocation method a few decades ago, with all generation capacity and transmission costs allocated

**Table 9. Results of two illustrative embedded cost of service study approaches**

Cost category	Revenue requirement	Legacy study: Peak responsibility/minimum system			Modern study: Base-peak/basic customer		
		Allocation method	Residential	Commercial and industrial	Allocation method	Residential	Commercial and industrial
<b>Generation</b>							
Baseload	\$100,000,000	Peak demand (1 CP)	\$60,000,000	\$40,000,000	All energy	\$50,000,000	\$50,000,000
Peaking	\$50,000,000	Peak demand (1 CP)	\$30,000,000	\$20,000,000	On-peak energy	\$27,500,000	\$22,500,000
Fuel	\$100,000,000	All energy	\$50,000,000	\$50,000,000	All energy	\$50,000,000	\$50,000,000
Subtotal			\$140,000,000	\$110,000,000		\$127,500,000	\$122,500,000
<b>Transmission</b>	\$20,000,000	Peak demand (1 CP)	\$12,000,000	\$8,000,000	75% all energy/ 25% on-peak energy	\$10,300,000	\$9,800,000
<b>Distribution</b>							
Circuits	\$50,000,000	50% peak demand/ 50% customer	\$37,500,000	\$12,500,000	75% all energy/ 25% on-peak energy	\$25,600,000	\$24,400,000
Transformers	\$20,000,000	Customer	\$18,000,000	\$2,000,000	75% all energy/ 25% on-peak energy	\$10,300,000	\$9,800,000
Advanced meters	\$10,000,000	Customer	\$9,000,000	\$1,000,000	50% customer/ 25% all energy/ 25% on-peak energy	\$7,100,000	\$2,900,000
Subtotal			\$64,500,000	\$15,500,000		\$43,000,000	\$37,000,000
<b>Billing and collection</b>	\$20,000,000	Customer	\$18,000,000	\$2,000,000	Customer	\$18,000,000	\$2,000,000
<b>Total</b>	\$370,000,000		\$234,500,000	\$135,500,000		\$198,750,000	\$171,250,000
<b>Average per kWh</b>	\$0.123		\$0.156	\$0.09		\$0.133	\$0.114
<b>Difference</b>						<b>-15%</b>	<b>+26%</b>

Note: Numbers may not add up to total because of rounding.

48 Some costs associated with providing service under rare combinations of load and operating contingencies may not fit well into this framework.



**Table 10. Illustrative allocation factors**

Method	Residential	Commercial and industrial
Peak demand (1 CP)	60%	40%
All energy	50%	50%
On-peak energy	55%	45%
Customer	90%	10%
50% peak demand (1 CP)/ 50% customer	75%	25%
75% all energy/ 25% on-peak energy	51.3%	48.8%
50% customer/ 25% all energy/ 25% on-peak energy	71.3%	28.8%

on the highest-hour peak demand and most distribution costs allocated based on customer count. The second uses a simple time-based assignment method, in which all costs are allocated to usage in the hours for which the costs are incurred. This method recognizes that costs have a base level needed to provide service at all hours and incremental costs to provide service at peak hours. It also recognizes the multiple purposes for which advanced meter investments are made. The results are quite striking, with the second study showing a residential class revenue requirement 15% lower than the first. This set of assumptions probably forms the bookends between which most well-developed embedded cost studies would fall.

The first approach presents a legacy method that some industrial and large commercial customer representatives still sometimes propose. The second is a method that residential consumer advocates often champion. This change in method drives a significant change in the result. Both of these are “cost of service” results.

The point of these illustrative examples is not to suggest a specific approach, nor to defend any of the individual allocation methods shown, but to illustrate how different classification and allocation assumptions affect study results. Simply stating that a proposed cost assignment between classes is “based on the cost of service” may ignore the very important judgments that goes into the assumptions of the study. Table 10 shows the illustrative allocators that drive the results in Table 9.

Figure 20 on the next page shows a Sankey diagram for the legacy embedded cost of service study shown in Table 9. In that legacy study, most costs are classified as demand-related, and 60% of demand-related costs get allocated to the residential class. Similarly, a significant amount of costs are classified as customer-related, which are then overwhelmingly allocated to the residential class. This is because the **minimum system method** classifies all metering, billing and line transformers as customer-related, along with a portion of the distribution system.

In contrast, Figure 21 on Page 77 shows a Sankey diagram for the modern study in Table 9. More than half of peak hours costs are allocated to the residential class, but the peak hours classification is much less significant than the demand-related classification in the legacy study. Similarly, the basic customer method classifies only billing and a portion of advanced metering costs as customer-related. These costs are still primarily allocated to the residential class, but the aggregated differential nevertheless comes out significantly lower than in the legacy study. The remainder of advanced metering costs is split between all energy and on-peak energy because the purpose of these investments is to reduce energy costs and peak capacity requirements.

Figure 20. Sankey diagram for legacy embedded cost of service study

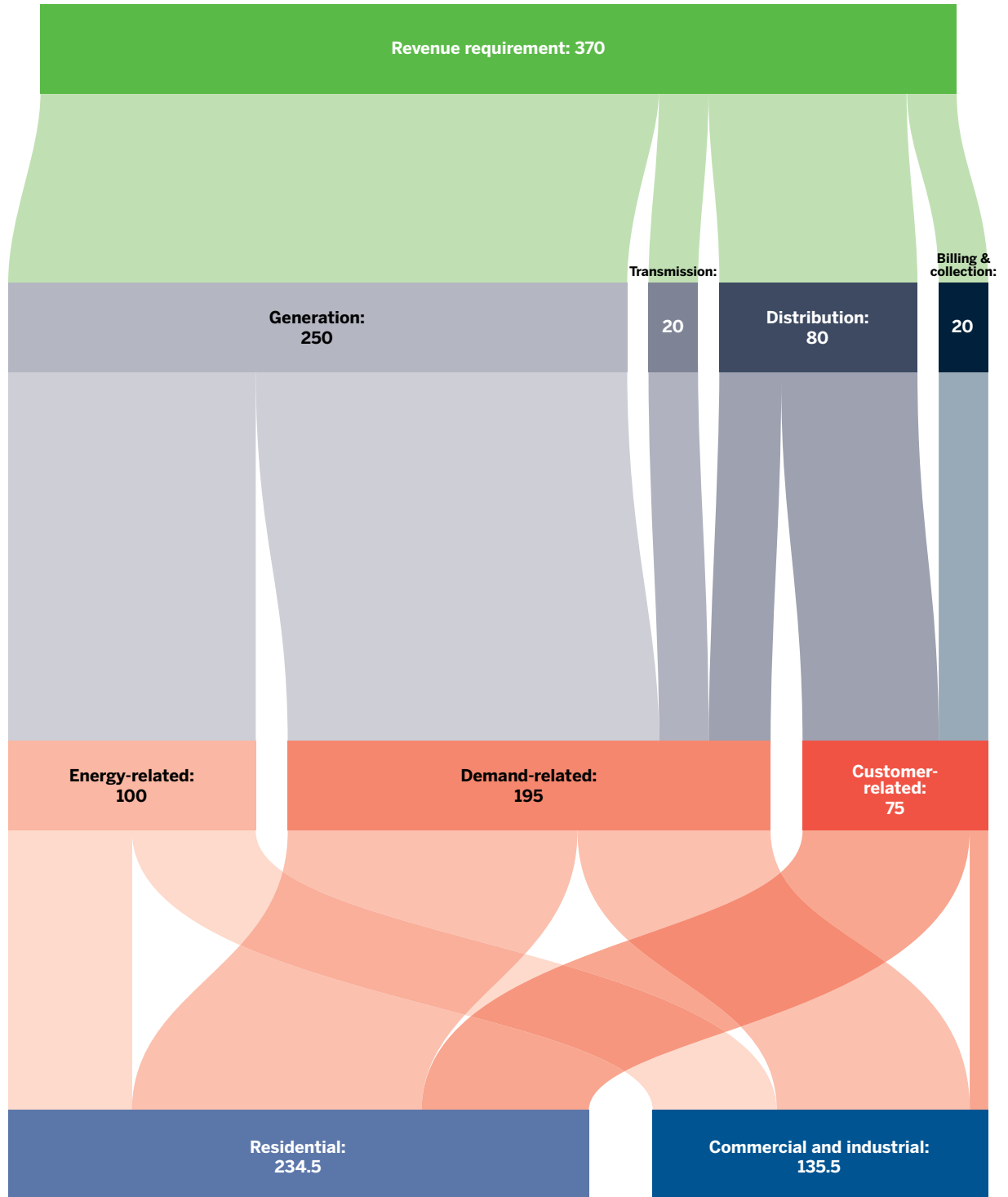
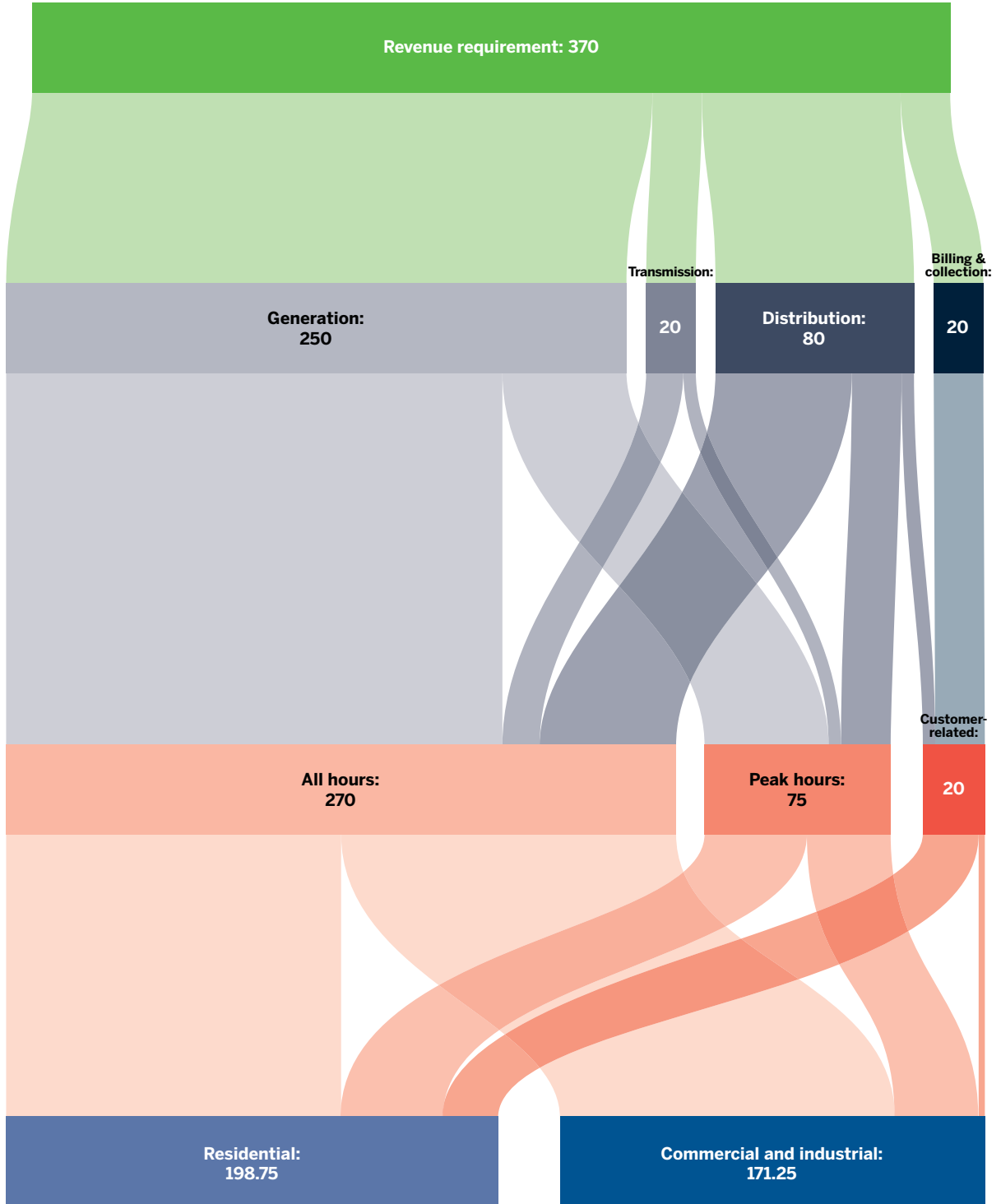

Figure 21. Sankey diagram for modern embedded cost of service study



### “Fixed” versus “variable” costs

In the past, some cost allocation studies have relied on a simplified model of cost causation, in which certain costs are labeled as variable and then classified as energy-related and apportioned among classes based on class kWh usage. The remaining costs, labeled as fixed, are classified as demand-related or customer-related and allocated on some measure of peak demand or customer number, respectively.<sup>49</sup> This antiquated approach is based on fundamental misconceptions regarding cost causation. But it still underlies many arguments about cost allocation, perhaps because it typically works to the benefit of customer classes with high load factors and small numbers of customers — which describes most utilities’ large industrial classes, data centers and even supermarkets.<sup>50</sup> This technique ignores the reality that modern electric systems trade off capital, labor, contractual obligations, fuel and other expenditures to minimize costs.

One of the problems with using the fixed/variable dichotomy to classify costs is the ambiguity of the concept of a cost being “fixed.” Nearly all observers agree that certain generation costs are variable because they are short-term marginal costs that vary directly with usage patterns. These costs include:

- Fuel purchasing and disposal costs.<sup>51</sup>
- Variable operating costs related to consumables (e.g., water, limestone, activated carbon, ammonia) injected to increase output, reduce emissions or provide cooling to the power plant as it produces energy.
- Allowances or offsets that must be purchased to emit various pollutants.

- Purchased power charges that depend on the amount of energy taken by the utility.<sup>52</sup>

Over the decades, nearly every other utility cost has been described as fixed in one context or another: capital, labor, materials and contract services. Most of these costs are fixed for the coming year, in the sense that they are committed (investments made, contracts signed, employees hired) and will not be immediately changed by usage levels (energy, demand or number of customers). However, almost all of these cost accounts are variable over a period of several years, and energy consumption may affect:

- Whether excess generation capacity or other redundant facilities can be retired or mothballed in order to reduce operating and capital expenditures or repurposed to increase the net benefits of the facility.
- Whether additional facilities are needed (increasing capital and operating costs).
- Whether contracts are extended.
- The cost of capacity that is built (e.g., combined cycle versus combustion turbine plants, larger T&D equipment to reduce losses).

As a result, these costs are not fixed over the planning horizon. From an economic perspective more generally, all costs vary in the long run.

Relatedly, nearly all competitive businesses and fee-charging public services recover their fixed costs based on units sold. Customers do not pay an access fee to enter a supermarket.

49 In rate design, this approach has been extended to argue that all “fixed” costs must be recovered through **fixed charges**, often meaning customer and demand charges. These approaches promote neither equity nor efficiency.

50 Similarly, the fixed/variable approach is attractive to those who would justify rate designs with lower energy charges and higher customer and demand charges.

51 In previous decades, utilities would even argue that some fuel costs are fixed, on the grounds that having fuel on hand was necessary to allow the plant to function when required, or that a certain amount of fuel was required for startup, before any energy could be generated. These arguments appear to have largely disappeared, although similar issues are raised by the fuel security debate at FERC.

52 Many observers would add another category — expenses whose amount and timing vary with hours of operation, output or unit starts — even though not all cost of service studies separate those costs from other O&M expenses.

Restaurants, theaters and airlines have many costs that can be characterized as fixed (land, buildings, equipment, a large share of labor) and vary their unit prices by time of use but ultimately recover their capital investments and long-term costs from sales of output. RAP has done extensive analysis of utility distribution system investment and the relationship of that investment to the number of customers, peak demands and total kWhs. We found that these costs are roughly linear with respect to each of these metrics (Shirley, 2001).

Some version of the fixed/variable distinction may have been close to reality in the middle of the last century. Most utilities relied primarily on fossil steam plants, using newer, more efficient plants to serve baseloads and older plants to serve intermediate and peak loads. The capital costs of each were not very different. Fuel costs for oil, coal and natural gas were not very different. And because little was required in terms of emissions controls, coal plants were not much more expensive than other fossil-fueled plants.<sup>53</sup> By the 1970s, however, conditions had changed radically. Oil prices rose dramatically, new coal plants were required to reduce air emissions, and new generation technologies arose: nuclear, with high capital and O&M cost but low fuel prices; and combustion turbines, with low capital and O&M costs but high fuel costs. Utilities suddenly had a menu of options among generation technologies, including the potential for trading off short-term fuel costs for long-term capital investments. Today that menu has expanded even more and includes storage, demand response, price-responsive customer load and distributed generation.

As a result, the fixed/variable distinction has lost relevance and adherents over the last several decades. For example, many regulators classify capital investments using methods that recognize the contribution of energy requirements to the need for a wide variety of “fixed” costs for generation, transmission and distribution.<sup>54</sup>

<sup>53</sup> In some areas, such as the U.S. Northwest, Manitoba and Québec, utilities had access to ample low-cost hydro facilities and mostly avoided construction of thermal generation.

<sup>54</sup> These methods are discussed in chapters 9, 10 and 11.

## 6.2 Marginal Cost of Service Studies

The fundamental principle of marginal cost pricing is that economic efficiency is served when prices reflect current or future costs — that is, the true value today of the resources that are being used to serve demand — rather than historical embedded costs. Advocates for a marginal cost of service study approach work backward from this pricing concept to suggest that cost allocation should be based around marginal costs as well. Critics of marginal cost methods often point out that this economic theory is appropriate only when other conditions are present, including that all other goods are priced based on marginal costs, that there are no barriers to entry or exit from the market and that capital is fungible.

This is a very broad concept because it abstracts from and does not consider both theoretical and computational issues associated with the development of marginal costs. In contrast to the static snapshot that is typical of embedded cost approaches, marginal cost of service studies account for how costs change over time and which rate class characteristics are responsible for driving changes in cost. Importantly, marginal costs can be measured in the short run or long run. At one extreme, a true short-run marginal cost study will measure only a fraction of the cost of service, the portion that varies from hour to hour with usage assuming no changes in the capital stock. At the other, a total service long-run incremental cost study measures the cost of replacing today’s power system with a new, optimally designed and sized system that uses the newest technology. In between is a range of alternatives, many of which have been used in states like Maine, New York, Montana, Oregon and California in determining revenue allocation among classes.

There is a strong theoretical link between optimal rate design and long-run marginal costs. Allocation based on marginal costs works backward from this premise; because pricing should be determined on this basis, cost allocation should as well. In its simplest form, a marginal cost study computes marginal costs for different elements of service, which can be estimated using a number of techniques, including proxies,

regressions and other cost data. Table 11 shows illustrative marginal costs for different elements of the electric system.

Different marginal cost of service studies may base their costing on different elements of the system or different combinations. The categories of costs included in each element can also be more or less expansive. The estimated marginal costs are then multiplied by the billing determinants for each class. This produces a class marginal cost revenue requirement and, when combined with other classes, a system MCRR. However, revenue determination solely on this marginal cost basis will typically be greater or less than the allowed revenue requirement, which is normally computed on an embedded cost basis. It is only happenstance if marginal costs and embedded costs produce the same revenue or even similar levels of revenue. As a result, a marginal cost of service study must be adjusted to recover the correct annual amount from the revenue requirement.

Two notable long-run methods are discussed in this section: the long-run marginal cost approaches advocated by Lewis Perl and his colleagues at the consulting firm National Economic Research Associates (NERA) — now NERA Economic Consulting — and the total service long-run incremental cost approach.<sup>55</sup> In the 1980s, during the PURPA hearing era, many states considered and a few adopted the **NERA method** to measuring long-run marginal costs. California, Oregon, Montana and New York are examples of states that began relying on this approach to measuring marginal costs. This methodology generally looked at a 10-year or longer time horizon to measure what costs would change in response to changes in peak demand and energy requirements during different time periods and the number of customers served (National Economic Research Associates, 1977). One essential element of this was to define the cost of generation to meet peak period load growth (peaker units and associated T&D capacity) as much higher than the cost to meet off-peak load growth (increased utilization of existing assets). This approach was influenced by Alfred Kahn's theoretical focus on peak load costs and management (Kahn, 1970), and he himself was associated with NERA for many years.

For generation, one of the theoretical advances that made marginal cost of service studies attractive when they were

**Table 11. Illustrative marginal cost results by element**

	Units	Cost per unit
<b>Customer connection</b>	Dollars per year	\$80
<b>Secondary distribution</b>	Dollars per kW	\$40
<b>Primary distribution</b>	Dollars per kW	\$80
<b>Transmission</b>	Dollars per kW	\$50
<b>Generation capacity</b>	Dollars per kW	\$100
<b>Energy by time period</b>		
On-peak	Dollars per kWh	\$0.10
Midpeak	Dollars per kWh	\$0.07
Off-peak	Dollars per kWh	\$0.05

first developed in the late 1970s was that generation costs were made up of capacity and energy costs, but the embedded plant was not classified to obtain these costs. Marginal energy costs were based on the incremental operating costs of the system (discussed in Chapter 18 in more detail), while capacity costs were the least cost of new capacity (at the time, typically a combustion turbine). The annualization for the capacity costs of all types is not based on the embedded rate of return but on a **real economic carrying charge** (RECC) rate that yields the same present value of revenue requirements when adjusted for inflation.

For transmission and distribution costs in the NERA method, the marginal costs have typically been estimated by determining marginal investment for new capacity over a number of historical and projected years and relating that investment to changes in some type of load or capacity measure in kW. This relationship can be found either using regression equations (cumulative investment versus cumulative increase in load over the time period) or by simply dividing the number of dollars of investment by the total increase in load over the time period. O&M costs are generally based on some type of average over a number of historical and projected years, although obvious trends or anomalies can be taken into account.

<sup>55</sup> Short-run marginal cost approaches are actually much simpler, primarily varying fuel consumption and purchased power costs, but are applicable only in a limited number of circumstances.

For customer costs, the same type of arguments over classification between distribution demand and customer costs occur as in embedded cost studies. The marginal cost study needs data on the current costs of hooking up new customers by class. The method for annualizing the costs is in dispute (RECC versus a **new-customer-only method** that assigns the costs by new and replacement customers). O&M costs are again typically based on some type of average over historical and projected years.

The time horizon used for the NERA approach has proven controversial because it assumed the utility would install exactly the number of new customer connections and distribution lines required by new customers (i.e., all customer costs are “marginal”) but would consider the adequacy of existing generation and transmission (which may be oversized to meet current needs) in determining the need for additional generation and transmission (meaning only some G&T costs are “marginal”). Many utilities have used a 10-year time horizon in this analysis, a period in which many found substantial excess capacity and, therefore, relatively low costs to meet increasing power supply needs. In addition, this methodology, as most often used, treats the cost of increased off-peak usage as only the fuel and variable power costs and losses associated with operating existing resources for additional hours, with no associated investment-related or maintenance-related cost, despite the reliance on expensive investments to produce that power.

The combination of these assumptions meant that many marginal cost of service studies over the last several decades would come to three basic conclusions:

- Power supply and transmission costs to meet off-peak loads were relatively low, due to available excess capacity.
- Power supply and transmission costs to meet peak load growth were higher.
- Distribution costs always grew in lockstep with the number of customers and distribution demands.

The most serious shortcoming of the NERA methodology is that if power supply is surplus due to imperfect forecasting, it assigns a very low cost to power; if it is scarce, the method assigns a very high cost. Neither of those circumstances is *caused* by the action of consumers in any class, but the

presence of either can shift costs sharply among consumer classes. Because of this imbalanced result, regulators have adopted modifications to this methodology to equalize the time horizon for different elements of the cost of service. For example, not all customers will require new service drops and meters over a 10-year period — only new customers and those whose existing facilities fail. Some states apportion costs within functional categories, avoiding this problem and addressing markets with partial retail choice.

In contrast to the NERA approach and other marginal cost approaches, which start from the parameters and investments found in the existing system, the total service long-run incremental cost approach looks at a period long enough so that all costs truly are variable. This allows for an estimate of what the system would look like if it were completely constructed using today’s technologies and today’s costs. Today, new generation is often cheaper than existing resources, while the cost of transmission and distribution continues to rise.

The TSLRIC approach was developed in the context of regulatory reform for telecommunications (International Telecommunication Union, 2009). In the 1990s, as telecommunication technology advanced rapidly, incumbent local exchange companies (better known as phone companies) faced competition from new market entrants that did not have legacy system costs. These new competitors were able to offer service at lower cost than the local phone companies. Regulators did not want to discourage innovation but also did not want existing customers served by the local phone companies to suffer rate increases if select customers left the system.

The TSLRIC approach constructs a hypothetical system with optimal sizing of components, with neither excess capacity nor deficient capacity. It would use the most modern technology. In the context of an electric utility, it would likely rely on wind, solar and storage to a greater extent than most systems today, which would likely lead to lower costs. But it would also incur the cost of today’s environmental and land use restrictions, such as the requirement for lower emissions from generation and undergrounding of transmission and distribution lines. These requirements have substantial societal benefits but can also drive up electric system costs.

One advantage of a TSLRIC study over a NERA-style study is that no class is advantaged or disadvantaged by a current surplus or deficiency of power supply or distribution network capacity, since costs for all classes would be based on an optimal mix of resources to serve today's needs. This is one of the most common critiques of the NERA methodology — that it favors any class that is served dominantly by the elements of a system that are in surplus.

### 6.3 Combining Frameworks

Several jurisdictions require both an embedded and a marginal cost of service study to support cost allocation and rate design. As a result, utilities and other parties may file several studies in the course of a rate proceeding. A regulator may reasonably use multiple cost studies in reaching decisions, using multiple results to define a range of reasonableness. Within that range, the regulator can apply judgment and all of the relevant non-cost concerns to determine the allocation of the revenue requirements among classes. Furthermore, the different types of studies provide different information that can be used at other stages in the rate-making process.

One approach is to use embedded cost methods to determine the allocation of the revenue requirement among customer classes and then a forward-looking cost method of some kind to design rates within classes. This applies the focus of embedded cost studies on equitably sharing the costs among classes while maximizing the efficiency of price signals in the actual rates that individual customers face in making consumption decisions that will affect future costs. The appropriate form of price signals can also be influenced by externalities that are not part of the embedded costs for a regulated utility. For example, many regulatory agencies that allocate costs among classes on embedded costs have reflected higher long-run marginal costs in adopting inclining block or time-of-use rates for customers with high levels of usage (either because large customers are better able to respond to price signals or because the larger customers have more expensive load shapes, such as for space conditioning).

In some situations, regulators will use one costing method to set rates for existing load while using a different

method to set rates for new customers or incremental usage. Some jurisdictions have applied this technique for rate design within classes — as the foundation for most “economic development” rate discounts where marginal costs are lower than embedded costs, as well as for inclining block rates where marginal costs are higher than embedded costs. In addition, some jurisdictions have applied this technique across rate classes, allocating new incremental resources to specific rate classes. Depending on the trajectory of costs, this can have two different intended purposes:

- To provide a foundation upon which to impose on fast-growing classes the high costs of growth and to shelter slower-growing classes from these new costs.
- To provide a foundation to give the benefit of low-cost new resources to the growing class.

This approach to differential treatment of incremental resources may be applicable to situations where costs are being driven by disparate growth among customer classes. In the 1980s, for example, commercial loads in the U.S. grew much faster than residential loads, and this technique could be used to assign the cost of expensive new resources to the classes causing those new costs to be incurred.

### 6.4 Using Cost of Service Study Results

Quantitative cost of service study results should serve only as a guide to the allocation of revenue responsibility among classes, not as the sole determinant. Even the best cost of service study reflects many judgments, assumptions and inputs. Other reasonable judgments, assumptions and inputs would result in different cost allocations. Additionally, loads may be unstable, significantly changing class revenue responsibility between cost studies, particularly for traditional studies that base costs on single peak hours in one or several months. More globally, concepts of equity extend beyond the cost of service study's assignment of responsibility for causing costs or using the services provided by those costs to include relative ability to pay, gradualism in rate changes, differential risks by function and class and other policy considerations.

Chapter 27 addresses the many ways in which the results of cost of service studies can be used to guide regulators.



## 7. Key Issues for 21st Century Cost Allocation

**M**any important cost allocation issues for the current era are fundamentally different from those that existed when NARUC published its 1992 *Electric Utility Cost Allocation Manual*. This chapter sets forth the changes the industry has experienced and describes the approaches that may be needed to address those changes in cost allocation studies.

Inevitably, additional costing issues will emerge and require recognition in future cost of service studies. The fundamental considerations are why the costs were incurred and who currently benefits from the costs. Costs are often categorized using engineering and accounting perspectives that are useful for many applications but must not be allowed to obscure the fundamental questions of causation and benefits.

### 7.1 Changes to Technology and the Electric System

Technological change has affected every element of the electric system since the studies and decisions that informed the 1992 NARUC cost allocation manual. These changes include:

- Improved distribution system monitoring and advanced metering infrastructure, leading to new comprehensive data on the system and customers.
- Evolution of resource options to include significant amounts of variable renewables, new types of storage, energy efficiency and demand response.
- Significant commitments to DERs behind customer meters, including rooftop solar and storage.
- Beneficial electrification of transportation.
- Changes in fuel prices and the resource supply mix that have dramatically changed the operating pattern of various generation resources (addressed in more detail in Section 7.2).

These changes both enable and require new approaches in order to efficiently and equitably allocate costs across customer classes.

#### 7.1.1 Distribution System Monitoring and Advanced Metering Infrastructure

In the past, customer meters were used solely to measure usage and render bills. Today, so-called smart meters are part of a complex web of assets that enable energy efficiency, peak load management and improved system reliability, in addition to the traditional measuring of usage and rendering of bills.

More recently, a number of utilities have used advanced meters to support demand response and other programs. Sacramento Municipal Utility District, for example, ran a pilot program to test the impacts of **dynamic pricing** and smart technology on peak load shaving and energy conservation. Figure 22 on the next page shows how customers in the program took steps to lower their electricity usage during high-load, higher-cost hours (Potter, George and Jimenez, 2014).

Smart meters (along with supporting data acquisition and data management hardware and software) can provide a number of services that improve reliability and reduce costs of generation, transmission and distribution.<sup>56</sup> Analysts have identified a wide range of expected and potential benefits.

These include:

- Reduced line losses.
- Voltage control.
- Improved system planning and transformer sizing.
- The ability to implement rate designs that encourage energy efficiency.
- Reduced peak loads.
- Integration of EVs and renewables.

<sup>56</sup> The broader concept of “smart grid” includes distribution (and sometimes transmission) automation devices such as automatic reclosers, voltage controls, switchable capacitors and sensors.

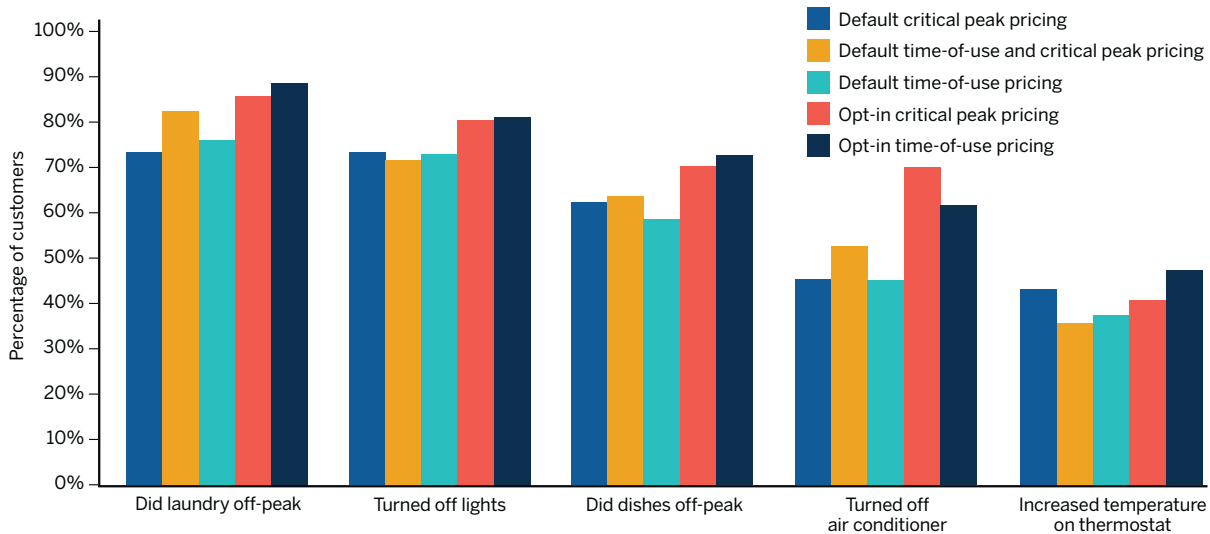
**Figure 22. Customer behavior in Sacramento Municipal Utility District pricing pilot**

Source: Potter, J., George, S., and Jimenez, L. (2014). *SmartPricing Options Final Evaluation*

- Operating savings from, among other things, reduced labor needs and improved outage management.

Lastly, smart meters, distribution sensors and modern computing power provide utilities with large amounts of data that can be used to determine the usage patterns of distribution and transmission equipment in great detail and support direct hourly allocation of costs.

### 7.1.2 Variable Renewables, Storage, Energy Efficiency and Demand Response

New variable renewable resources, such as wind and solar, are highly capital-intensive, and their contribution to system reliability varies greatly from region to region depending on when their generation occurs relative to peak demand.<sup>57</sup> The emergence of demand response as a service provides an opportunity to meet narrow periods of peak demand with relatively little capital investment by rewarding customers who curtail usage on request.

Investments in renewable resources, driven by policy and economic trends, can greatly change patterns in supply and

demand that had been roughly constant for decades. Due to significant solar capacity in some regions, such as California and Hawaii, costs (e.g., extra **spinning reserves**, out-of-merit dispatch or quick-start generation) may also be incurred to rapidly ramp up other generation as solar output falls in the late afternoon, particularly if customer load does not drop dramatically from afternoon to evening.<sup>58</sup> Excess solar generation may create ramping costs, while storage resources may reduce ramping costs by both raising load at the beginning of the ramp period and trimming the peak toward the end of the ramp period.

In Hawaii, June load shapes changed as increased levels of distributed solar were added to the system. Figure 23 on the next page illustrates this, using data from the Federal Energy Regulatory Commission (n.d.). In 2006, the **system peak demand** was approximately 1,200 MWs at 1 to 3 p.m. By 2017, with extensive deployment of customer-sited solar, the peak demand was 1,068 MWs at 9 p.m. A cost allocation scheme must be adaptable enough to be relevant as significant changes in the shape and character of utility-served load take place.

<sup>57</sup> Growth in solar resources, whether central or distributed, gradually reduces the reliability value of incremental solar capacity in many respects; the same is true for wind resources with respect to the reliability value of incremental wind and the equivalent for (if they become economically

competitive) tidal and wave energy. In contrast, these different resources may be complementary to one another in certain respects.

<sup>58</sup> The resulting load shape, first identified by Denholm, Margolis and Milford in 2008, is commonly known as a duck curve. See also Lazar (2016).

**Figure 23. Evolution of system load in Hawaii on typical June weekday**

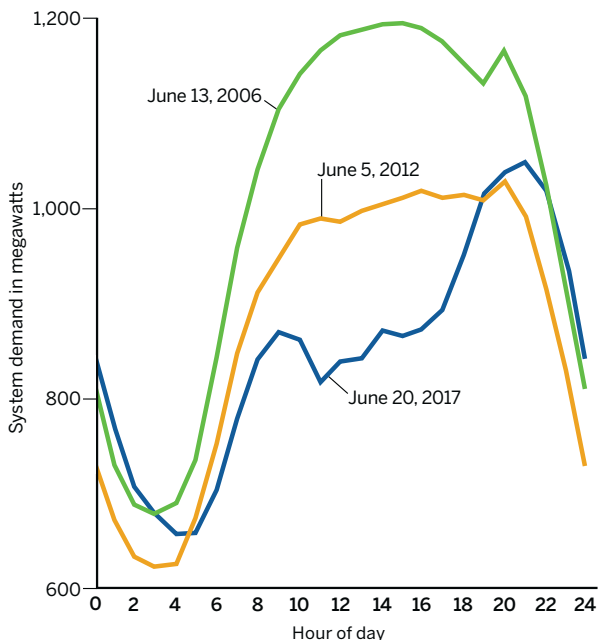

Data source: Federal Energy Regulatory Commission, Form No. 714  
— Annual Balancing Authority Area and Planning Area Report

The capacity role and treatment of variable renewable resources, such as wind and solar, vary among jurisdictions and RTOs. The cost of service study should reflect the role of these resources in supply planning, by classifying part of the renewable costs as demand-related and allocating those costs in proportion to class consumption in the hours contributing to capacity requirements. This should recognize that different types of variable renewable resources can be complementary in many respects as long as the temporal patterns, either daily or seasonal, are different. Even solar in slightly different regions can be complementary since they may not be affected in an identical way by cloud cover. For example, as shown in Figure 24 on the next page, a mix of wind resources from West and South Texas plus solar production combine to produce an overall resource shape that corresponds moderately

well to the shape of the summer diurnal load (Slusarewicz and Cohan, 2018; Electric Reliability Council of Texas, 2019).

The costs of these resources can be assigned to the hours in which they generate energy, as discussed in Chapter 17. Determining the hours that variable resources provide energy (on either a historical or normalized forecast basis) is generally straightforward.

Distributed storage presents other issues and opportunities, as it is a capital-intensive peaking resource with no direct fuel costs, dependent on charging from other resources, and provides a variety of energy, capacity, transmission, distribution and **ancillary services** to the system and sometimes backup supply to host customers. Storage may displace T&D investments, reduce fuel consumption, enable renewable energy integration and provide emergency service at customer sites. Each of these functions has a different place in a modern cost allocation study.

A portfolio of energy efficiency measures reduces energy requirements, generation capacity requirements and stress on T&D equipment, as well as reduces customer billing determinants. As discussed in Section 14.1, energy efficiency expenditures can be classified and allocated in proportion to the benefits they produce. The plans and evaluation reports of the program administrator (the utility or a third party authorized to provide those services) generally provide sufficient data on the load shape and class distribution of load reductions. Since energy efficiency costs are recovered through a variety of mechanisms (rate based or expensed, through base rates or a discrete conservation surcharge or **rider**), the cost allocation should reflect the cost recovery method.

The costs of demand response programs — direct load control, customer load automation (e.g., setback thermostats) and price-responsive load (e.g., critical peak pricing) — should similarly be apportioned to reflect their benefits, so that cost-effective demand response is a net benefit to both participants and nonparticipants.<sup>59</sup> An hourly assignment method, where the costs of demand response are apportioned

59 Under conventional rate designs, participants (and their classes) generally retain a smaller share of the benefits of demand response (other than incentives for program participation, which may include peak-time rebates) than of energy efficiency programs. Depending on the program design, the incentives for the participants may be reflected in cost allocation and rate design through (1) reduced allocation of costs to the participating

customers and classes to reflect improved load shape, (2) payment of incentives (including peak-time rebates) and allocation of those and other utility expenditures as costs, or (3) a combination of the two, as long as the benefits are not double-counted. Dynamic peak pricing may encourage demand response without explicit incentives, with the cost allocation to the participants' class reflecting the improved load shape.

Figure 24. Illustrative Texas wind and solar resource compared with load shape

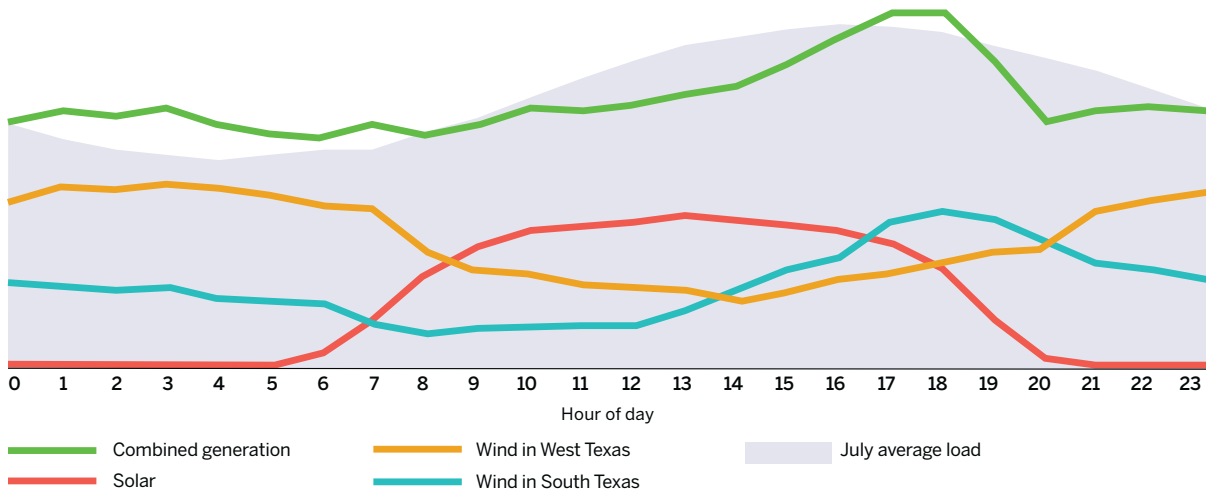

Sources: Adapted from Slusarewicz, J., and Cohan, D. (2018). *Assessing Solar and Wind Complementarity in Texas* [Licensed under <http://creativecommons.org/licenses/by/4.0>]. Load data from Electric Reliability Council of Texas. (2019). *2018 ERCOT Hourly Load Data*

to the hours when it is called upon (to reduce load or provide operating reserves), may help match costs to benefits across classes.

### 7.1.3 Beneficial Electrification of Transportation

Electric vehicles currently use less than 1% of the nation’s electricity, but that is expected to rise sharply in the next two

decades. However, the precise rate of expansion is uncertain. Figure 25 shows three alternative projections for sales of electric vehicles (Rissman, 2017).

For cost allocation purposes, there are two interrelated issues: how to treat existing customers who adopt EVs as well as new dedicated EV charging accounts, and how to allocate the costs of new utility EV programs, both for demand management and investments in charging stations.

Figure 25. Forecasts of electric vehicle share of sales

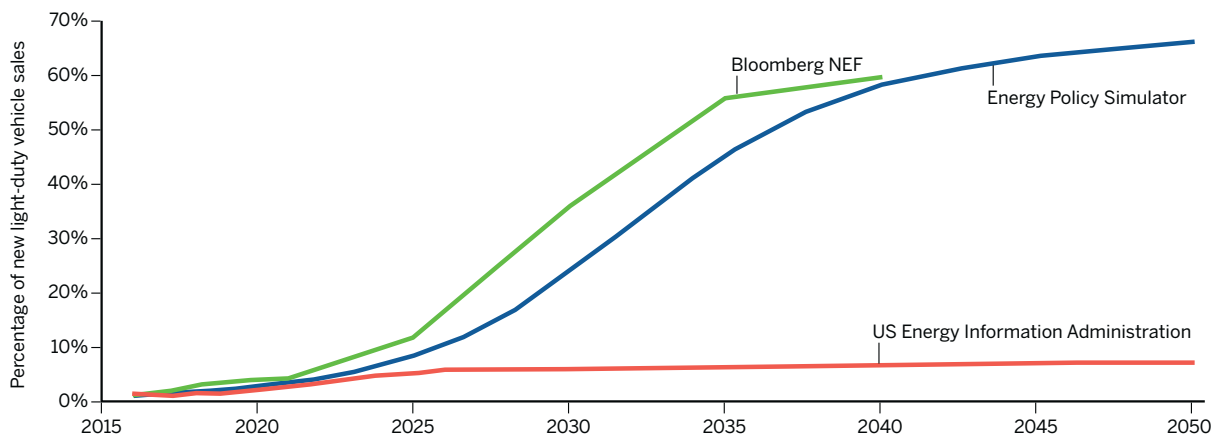

Note: Projections of U.S. market share of EVs are from the Energy Policy Simulator 1.3.1 BAU case, the Energy Information Administration *Annual Energy Outlook 2017* “No Clean Power Plan” side case, and the Bloomberg NEF *Electric Vehicle Outlook 2017*.

Source: Rissman, J. (2017). *The Future of Electric Vehicles in the U.S.*

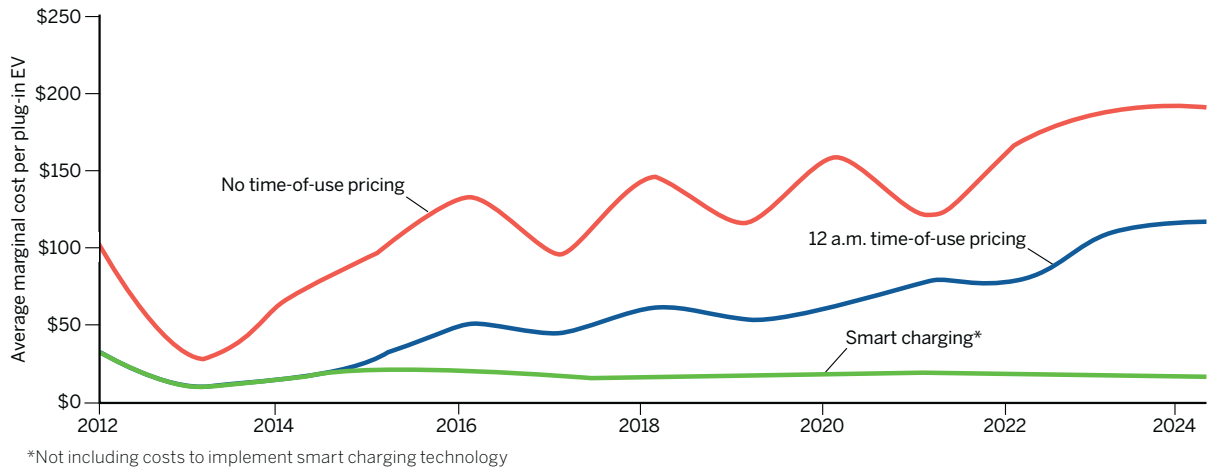
**Figure 26. Estimated grid integration costs for electric vehicles**

Source: Sacramento Municipal Utility District, personal communication, July 8, 2019

EVs are first being adopted in light-duty vehicle market segments, which primarily equates to residential adoption. These EVs are charged predominantly at home; there is a general consensus that home charging comprises over 80% on average (U.S. Department of Energy, n.d.). This home EV charging represents a substantial, but not totally unprecedented, amount of new consumption for a residential customer. The annual consumption for an EV represents slightly less than the consumption required for a typical electric water heater (U.S. Department of Energy, n.d.). If uncontrolled, however, this additional consumption could change the load profile significantly for this subset of customers, potentially leading to additional system costs. For example, if EVs begin to charge at home right after the workday ends and the sun is setting, then this could increase system peak and exacerbate ramping issues.

Between rate classes, changes in load profiles can be easily accounted for in future rate cases as long as there is sufficient load research data on the issue. However, there could also be significant changes in customer load profiles within each rate class. As a result, some analysts have suggested that residential customers with EVs should be a separate rate class. As a threshold matter as discussed in Section 5.2, it is an empirical question whether customers with EVs have distinct cost characteristics from other customers in the same rate class

and whether EV adoption is high enough within the rate class to have an impact on the other customers. However, assuming for the sake of argument that these thresholds are crossed, there are alternative ways to address the issue. It is not a given that EV charging will increase system peak or otherwise negatively impact other customers. Time-of-use rates and other demand management programs can significantly lessen these impacts. Figure 26 shows estimated grid integration costs for uncontrolled EV charging and two alternative methods for managing EV load (Sacramento Municipal Utility District, personal communication, July 8, 2019).

Many jurisdictions are moving toward widespread TOU rates for residential customers. If these rates are mandatory for residential customers or even just the default for residential customers with EVs, then that would likely eliminate any cross-subsidy issues between residential customers with and without EVs. Similarly, EVs can be easily integrated into other demand management programs, or programs specific to EVs can be examined.

At some point, similar issues may arise for workplace charging for light-duty vehicles, and it will be desirable to concentrate charging into the hours when generation and delivery system capacity is available and unused. For example, it may be desirable to concentrate workplace EV charging during periods when solar generation is prevalent.

As of this writing, many different heavy-duty EVs are beginning to be adopted. Many jurisdictions have started to adopt electric buses, and a wide range of electric trucks are under development, from postal and parcel urban delivery vehicles to long-haul semitrailers. Fleets of these vehicles will have charging requirements measured in MWs, not kW, and it may be desirable to locate these charging facilities where they can be directly served from the transmission network, avoiding the primary distribution network altogether. In this case, these sites will be more like large industrial high-voltage customers for cost analysis purposes. Making potential customers aware of this option, to access lower-cost power by locating adjacent to transmission capacity, may help guide the evolution of this market segment on an economical pathway.

Lastly, the development of public DC fast charging, thought by many to be a prerequisite to scale up EV adoption dramatically, is posing a range of new public policy issues. DC fast chargers allow for significantly faster recharging than other charging methods, which may be necessary for a variety of EV use cases, including long-distance travel and adoption in areas where residents cannot charge at home. The power rating of DC fast chargers is typically over 50 kW per charging port and could increase significantly (Nicholas and Hall, 2018). These characteristics mean that DC fast chargers typically cannot be installed for single-family residential customers. However, DC fast chargers can be installed at many commercial and industrial locations with a sufficient service capacity (e.g., a mall) or connected directly as a stand-alone C&I customer with a separate account.

Many jurisdictions have been wrestling with the proper rate class and rate design for stand-alone DC fast charger accounts. This is because these accounts have a load profile without an obvious correspondence to other C&I rate classes. These accounts have typically been placed in rate classes with significant demand charges. However, given the high kW power rating and low utilization rates at this early stage of EV adoption, high demand charges lead to extraordinarily high bills for these fast charging accounts, at least on an average cost per kWh basis. Given the broader public policy need for public DC fast charging, a number of jurisdictions have begun to take steps to lower bills for these accounts, either through

outright discounts or alternative rate structures. To date, there are significant tensions in all of the proposed solutions for these DC fast charging accounts. Given the significant site infrastructure needed to connect the uncontrolled power draw from DC fast chargers, the customer NCP demand for these accounts could be a relevant cost driver. RAP's preferred C&I rate design accounts for this by requiring modest customer NCP demand charges for site infrastructure (\$1 to \$2 per kW) with other elements of the rates established on a time-varying per-kWh basis. Such a rate would provide the right blend of incentives to manage usage for DC fast chargers through storage or other techniques. As a result, reforming rate design for C&I customers could be the optimal solution to this issue, instead of establishing separate rate classes for DC fast charging or providing arbitrary discounts under existing C&I rate designs.

Several states have also begun to implement utility EV programs, and many more states are considering policies in this area. Expenditures by regulated utilities to support electric vehicles are justified on a wide array of grounds:

- Societal benefits: public health and climate benefits, energy independence and reduced noise.
- Electric system benefits to all ratepayers: new load at beneficial off-peak hours and flexible new loads to optimize ramping.
- Benefits to participating customers and EV drivers: increased convenience, lower total driving costs and the potential to attract new customers to retail businesses.

One category of utility EV programs is quite similar to other energy and demand management programs. In the aggregate, uncontrolled EV load could be a significant addition to peak load that drives many system costs. These utility EV programs encourage, or in some cases ensure, that EV charging will take place during off-peak hours to minimize system stress and long-run electric system costs. The justifications for these programs and the principles for allocating the costs are not very different from other energy management and demand response programs, with functionalization, classification and allocation according to the benefits of the program or alternatively to classes in proportion to customer participation.

In contrast, another major category of utility EV programs does raise new questions. Utility expenditures and investments in support of charging infrastructure are taking a wide variety of forms, including rebates, additional allowances for interconnection costs, and direct utility ownership and operation of end-use charging stations. In most of these programs, participants are expected to bear some of the costs of the charging station, either upfront or ongoing, although a few programs may include full utility ownership and responsibility for all ongoing costs. Drivers of EVs are certainly the most direct beneficiaries of these programs, but there are a wide range of potential benefits for other ratepayers and society at large. Depending on the perspective, this could justify a wide range of cost allocation techniques, including:

- Direct assignment to the customer classes receiving free or subsidized equipment.<sup>60</sup>
- Allocation to all classes in proportion to class revenues or energy use to reflect the benefits to each class from increased sales and reduced average costs.
- Direct assignment to EV program accounts or a broader group of identifiable EV customers as program beneficiaries.<sup>61</sup>

These programs are still quite new at the time of publication for this manual, so many of the important issues are only beginning to be investigated. This is further complicated by cross-cutting issues, such as the integration of energy management programs into utility EV infrastructure investments and the impacts of cost allocation decisions on the competitive EV charging market and charging station providers who do not (or cannot) benefit from utility support.

One logical outcome across these issues could be applying fully loaded time-varying rates to identifiable EV accounts, which may provide higher incremental revenue than incremental costs in those hours. This would have the effect of socializing a substantial portion of EV program costs across a broader group of ratepayers. This would be consistent

with efforts to jump-start an infant industry. EV charging station program cost responsibility could be more directly concentrated toward EV drivers over time. This could mean specialized ongoing cost recovery mechanisms, including direct assignment of identifiable EV-related costs. However, a jurisdiction that is seeking to accelerate EV adoption would certainly be free to apply short-run marginal cost-based economic development rates to EV charging development while simultaneously socializing EV program costs to all ratepayers.

### 7.1.4 Distributed Energy Resources

Over the last decade, DERs, particularly rooftop solar, have gained significant traction in many jurisdictions. Many states adopted net metering rules for rooftop solar and other eligible technologies in the 2000s.<sup>62</sup> The federal government also established the investment tax credit for commercial and residential solar systems in 2005, which was thereafter extended and expanded to other solar applications. Starting in the late 2000s, costs for solar panels started to drop quickly. These policies and trends, in addition to a range of additional state policies and incentives, have created a significant new market for rooftop solar. As shown in Figure 27 on the next page, adoption of residential solar accelerated to significant levels in the mid-2010s, with more than 2 GWs of installations annually from 2015 through 2018 (Wood Mackenzie Power & Renewables and Solar Energy Industries Association, 2019, p. 20).

Customer-sited adoption of solar can raise several cost allocation issues. Unlike EVs, distributed solar reduces customer load. At the macro level, for utilities without **decoupling**, this can lead to underrecovery of revenue and necessitate more frequent rate cases. If adoption of distributed solar is captured in the load research data, then cost allocation between rate classes may change over time depending on the cost allocation techniques used.

The more difficult issue that jurisdictions around the country have been wrestling with is the possibility of

60 The number of EV program participants in a class, but not the total number of customers in the class, may be relevant to allocation of the costs.

61 There are a number of potential variants on this. Direct recovery of costs from a given customer for installation at that customer's site over time would act as a financing mechanism for that customer. However, specific program costs (e.g., a DC fast charger program) could be recovered

through a combination of subsidies from other classes and an ongoing per-kWh basis from the accounts that participated in that program.

62 The 2005 Energy Policy Act added net metering to the PURPA standards that each state was required to consider. Pub. L. No. 109-58 § 1251. Retrieved from <https://www.congress.gov/109/plaws/publ58/PLAW-109publ58.pdf>

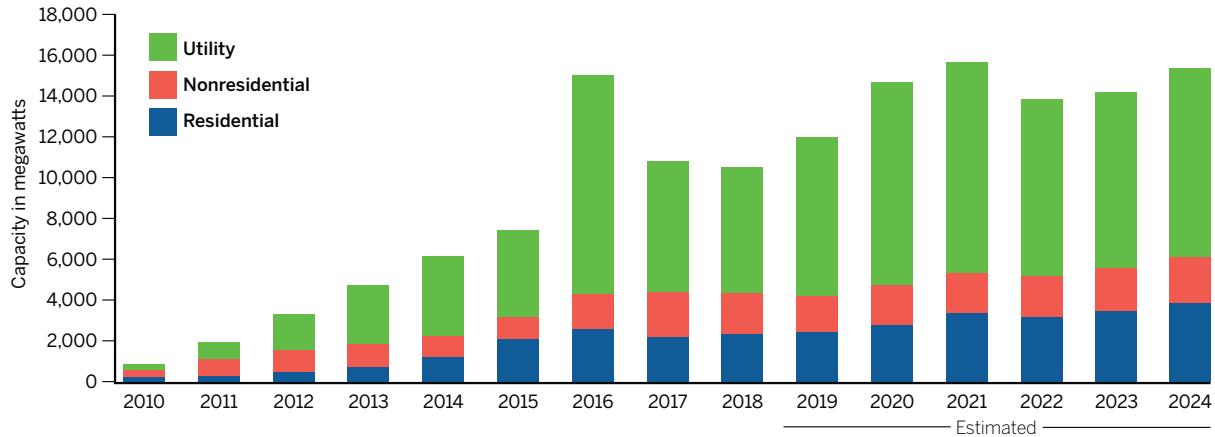
**Figure 27. US solar photovoltaic installations**

Source: Wood Mackenzie Power & Renewables and Solar Energy Industries Association. (2019, March). *U.S. Solar Market Insight*

intra-class cross-subsidies between customers with solar and those without. Many utilities have proposed special rate designs, changes to net metering rules and separate rate classes for customers with solar. As always, the threshold issue for creating a new rate class is whether customers with solar are having material impacts on the other customers. Some utilities and consumer advocates argue that net metering rules allow customers with solar to pay less than their fair share of system costs. It is important to quantitatively evaluate these concerns before making policy adjustments to address them.

To begin, the levels of distributed solar adoption across the country are quite uneven. While many jurisdictions have significant levels of adoption, particularly those with either strong solar resources (such as California and Hawaii) or supportive state policy environments, many other jurisdictions have low levels of adoption. In jurisdictions with low levels of adoption, the impacts on other customers are necessarily quite small. If only 1% of class load is accounted for by distributed solar, then the worst-case scenario is approximately 1% higher bills for nonparticipating customers, with a strong

likelihood of lower impacts given the offsetting benefits of solar generation.<sup>63</sup>

Even in jurisdictions with significant penetration levels of distributed solar, there have been robust debates about the existence of significant cross-subsidies and the proper means to address them. As a general matter, most proposals to establish separate rate classes for distributed solar have been denied so far.<sup>64</sup> Utilities have also proposed higher customer charges and special demand charges for solar customers, which have not been widely adopted. However, a variety of rate design changes have been adopted to better align compensation with value and reduce the potential for unreasonable cross-subsidies. California has begun to address these issues by requiring new residential net metering customers to be placed on TOU rates, a measure that is integrated with a move toward TOU rates for residential customers more generally (California Public Utilities Commission, n.d. and 2016). New York's Value of Distributed Energy Resources proceeding has set up specialized export credit compensation for large distributed energy projects, which include values

<sup>63</sup> Net ratepayer impacts from solar policies depend on many factors. In jurisdictions with significant renewable portfolio standard costs or separate solar incentive programs, these costs can be quite different than in jurisdictions where the primary solar compensation policy is net metering. It is important to distinguish whether costs to nonparticipating ratepayers are occurring because of the RPS, dedicated solar incentive programs or net metering policies.

<sup>64</sup> The exception to date is Kansas, although separate rate classes for solar customers have been authorized by legislative action in additional states (Trabish, 2017). At the time of this writing, this area of policy is rapidly evolving.

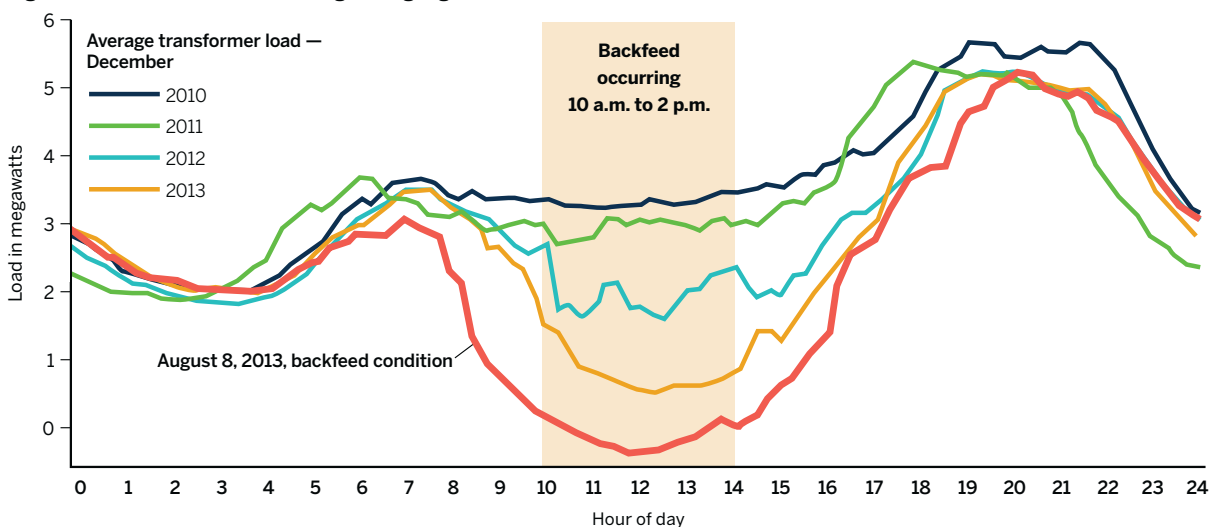

**Figure 28. Substation backfeeding during high solar hours**

Source: Hawaiian Electric Company. (2014, April 30). *Minimum Day Time Load Calculation and Screening*. Distributed Generation Interconnection Collaborative (DGIC) webinar

for energy, capacity, delivery and environmental externalities (New York Public Service Commission, 2017). Tensions in these debates include differentials between short-term and long-term avoided costs due to distributed generation and how to consider significant societal externalities such as greenhouse gas emissions.

Customer-sited storage is another DER that is expected to grow in importance in the coming decades. Storage can be used to change the load profile for adopting customers and even export energy to the grid if the jurisdiction allows it. Under flat volumetric rates, there is little incentive to manage energy usage with storage and little risk of unusually significant cross-subsidies. However, storage is becoming economically attractive in many jurisdictions to C&I customers that have high demand charges. These demand charges may not be well designed economically, and storage could allow these customers to lower their bills substantially. More generally, well-designed time-varying rates and demand charges can give the proper incentives for energy management through storage, but poorly designed rates will give customers correspondingly poor incentives.

Lastly, higher penetrations of DERs will raise new issues around the allocation of local distribution facilities. As more DERs are added, there will be some systems where primary

or transmission voltage customers receive a portion of their power from generating facilities located along distribution circuits. Where this occurs, some provision should be made to treat a portion of the distribution investment as a generation-related cost. Figure 28 shows how some distribution substations may backfeed to the transmission system during solar hours, even if the solar facilities are sited exclusively on the rooftops of secondary voltage customers (Hawaiian Electric Company, 2014).

## 7.2 Changes to Regulatory Frameworks

As also introduced in Chapter 4, many new regulatory issues have arisen since the 1992 NARUC *Electric Utility Cost Allocation Manual*, and some older issues have become more prominent and widespread. These issues include:

- Restructuring and the emergence of organized wholesale markets and **retail competition**.
- Holding company issues due to widespread mergers and new utility conglomerates.
- Performance-based revenue frameworks.
- Proliferation of **trackers** and riders recovering costs outside of rate cases.
- New types of public policy programs.

- Consideration of differential rates of return in cost allocation studies.
- Recovery of **stranded costs**, assets with changed purposes and exit fees.

## 7.2.1 Restructuring

A few issues in cost allocation are specific to restructured electric utilities and **distribution system operators**.

### Administrative and General Expenses

The most important of these issues may be that A&G costs become a larger share of total costs. As utilities have been restructured, not all have trimmed their management ranks or reduced executive compensation in proportion to the reduction in gross revenues. Regulators may need to use utilities that have never had production as proxies to determine appropriate cost levels to be assigned to distribution services and the apportionment of that cost. Even for **restructured utilities** that do not own generation assets, there are costs of maintaining involvement in regional power planning activities, ISO and RTO involvement and NERC involvement that are more closely related to power supply than the ownership and operation of a distribution system. Memberships in various industry organizations may be power supply-related as well.

### Provision of Generation Services

In most states allowing retail competition, the distribution utility also procures and offers, at cost, a **default power supply** service for customers who do not choose an alternative retail electricity supplier.<sup>65</sup> These costs normally will not be included in the cost of service study during a base rate case because they apply only to an optional service and are set through a separate proceeding, generally by competitive bidding to supply individual classes based on their historical load shapes.<sup>66</sup> Any costs incurred by the utility to procure these

services should be recovered through the default service, without affecting rate case revenue requirements.

Currently, default service is typically offered on a single residential load profile. We anticipate in the future this will become more granular,<sup>67</sup> at least with respect to time of day and season. This may be done with separate default tariffs for different subclasses of customers, such as multifamily, electric heating or electric vehicle owners. Or it may be done more simply, with a time-varying default service option that applies the same rates to all customers in each period, resulting in different average rates to customers with different usage patterns. A regulator may choose to reconfigure, for retail pricing purposes, these costs on a time-varying basis; if this occurs, the rate analyst must track this change into the cost allocation process.

Some ISOs (for example, ISO-NE, MISO, PJM) apply separate capacity charges and energy charges for power supply delivered to retail providers. Others (such as ERCOT) have eschewed capacity markets, instead concentrating on time differentiation of costs on a volumetric basis and allowing competitive energy prices to rise to levels reflective of scarcity and the value of lost load.<sup>68</sup>

The rate analyst may be in the position of second-guessing the ISO pricing, just as has been the case for natural gas utilities and FERC-approved pipeline charges for decades. If the ISO has treated some costs as capacity-related that can be more economically avoided with storage or demand response within the utility service territory, it may be appropriate to recharacterize these ISO costs as partly capacity-related costs and partly energy-related costs.

### Transmission Costs

In addition to billing for generation capacity and energy in most cases, all ISOs/RTOs bill for transmission service. Most assign transmission costs, project by project, to geographic areas, based on the historical ownership of older

65 Texas has not had any form of default supply since restructuring; all customers must choose a retail electricity supplier.

66 If the utility procures default service at a single price for multiple classes, the regulator should consider whether to differentiate the rates to reflect differences among the classes.

67 See Hledik and Lazar (2016) for a discussion of future pricing options to enable optimal utilization of DERs to meet system and local capacity requirements.

68 We note that the costs of the Alberta capacity market are spread on a time-differentiated volumetric basis rather than a traditional demand charge; this may be a useful model for U.S. ISOs. For a more robust discussion, see Hogan (2016).

facilities and the loads justifying new facilities. If those charges are billed on a capacity basis, the pricing may exceed the cost of avoidance of some transmission capacity but still be necessary for moving energy at nonpeak hours.<sup>69</sup> In this situation, the analyst may need to consider whether some transmission costs are imprudent and should be excluded from the revenue requirement or, perhaps due to how the assets are used, to split these costs between demand and energy.

There are many circumstances where the analyst must look through ISO pricing to determine an appropriate basis for retail cost allocation. For example, ERCOT charges for transmission primarily on a 4 CP basis for the summer months (June through September). Similar approaches may be used in FERC-regulated transmission agreements among affiliates outside of ISOs. These pricing methods and the resulting allocations are administrative simplifications and do not necessarily reflect cost causation. The ISO cost allocations do not control the retail allocation of transmission costs among customer classes or the manner these costs are reflected in rate design.

## 7.2.2 Holding Companies

There have been more than 100 mergers of electric utilities since the 1992 NARUC manual. This phenomenon was accelerated in 2005 when Congress repealed the Public Utility Holding Company Act. This has resulted in very different corporate relationships than existed in the 1980s and has created myriad issues to consider in the cost allocation process, from executive compensation to interservice allocation procedures.

Most utility mergers and acquisitions are justified by projections of more efficient management and a corresponding decline in administrative costs. Determining whether these promises have been realized is a revenue requirement issue beyond the scope of this manual. But the apportionment of administrative costs among unregulated and utility functions, and among utilities within the holding company, are often part of cost allocation. The increased complexity of utility holding companies makes this task more difficult.

Many state utility commissions have taken steps to exclude from the revenue requirement any incentives such as higher executive compensation that reward shareholder benefits (such as for a higher stock price) or rewards for good performance in unregulated operations. Determining the portion of executive compensation that is attributable to the utility operations, as contrasted with corporate profit maximization, is not straightforward. This question may be approached by using senior management costs at public agencies (such as state departments of transportation, health and education or universities) as a proxy for the portion of executive compensation that should be allocated to utility service. Large public agencies may have budgets, employee counts and subordinate levels of management comparable to those of utilities.

Different business operations of a modern utility holding company have different risks and rewards. Although management of a distribution utility is complex, the amount of innovation and risk is fundamentally different than in other business units of the holding company. As noted by the U.S. Supreme Court:

A public utility is entitled to such rates as will permit it to earn a return on the value of the property it employs for the convenience of the public equal to that generally being made at the same time and in the same region of the country on investments in other business undertakings which are attended by corresponding risks and uncertainties, but it has no constitutional right to profits such as are realized or anticipated in highly profitable enterprises or speculative ventures.<sup>70</sup>

By the same logic, a utility is entitled to recover the management costs of a company with similar complexity and risk but not necessarily those of a more speculative business operation.

Shareholder service costs — such as the cost of maintaining shareholder data, issuing dividends, issuing new capital stock and annual meeting costs — must be

69 The Vermont regulator has regularly identified specific nodes where increased efforts for energy efficiency can reduce the need for transmission or distribution capacity upgrades (Vermont Public Service Board, 2007; Vermont System Planning Committee, n.d.). This may provide a foundation for classification of ISO transmission charges

and for functionalizing some of these energy efficiency investments as transmission-related or distribution-related capacity costs.

70 *Bluefield Water Works v. Public Service Commission*, 262 U.S. 679, 692-93 (1923).

apportioned between the non-utility enterprises and the electric utility. Simple methods such as gross revenue or gross capital may be used; more complex methods looking at the number of employees, the contribution to earnings or other factors may also be appropriate.

Holding company insurance costs are substantial. Some are directly related to the utility service business, some are directly related to non-utility operations, and some are shared expenses. As with administrative costs and shareholder service costs, the most appropriate allocation method may need to rely on proxies of enterprises with simpler structures.

### 7.2.3 Performance-Based Regulation Issues

Performance-based regulation has emerged as a central theme in utility regulation. Although the genesis of PBR long predates the 1992 NARUC cost allocation manual, new and different approaches are being developed and implemented today. Early PBR mechanisms were simple price caps or discrete adders for specific investments.<sup>71</sup> The relevant issue for this manual is how to treat PBR costs and benefits in the cost allocation process.

The central concept of PBR is greater emphasis on the achievement of public policy objectives — such as lower customer costs, improved fuel cost performance, better reliability, increased reliance on preferred resources or other discrete goals — coupled with lower reliance on investment levels as a determinant of earnings. This tends to increase the operating expenses to cover the incentives while decreasing both investment and operating expenses when the incentives achieve cost savings.

The incentives may be in the form of a higher allowed rate of return based on achieving policy goals or discrete bonuses for achieving specific objectives. Similarly, penalties for underperformance can take a number of forms. The costs to ratepayers of PBR may include the incentives paid to shareholders as well as expenditures undertaken to achieve the PBR goals.<sup>72</sup> Those costs should be allocated to classes

in proportion to the benefits they receive, and penalties returned to ratepayers should be allocated in a manner similar to the distribution of the excess costs that prompted the penalties.

One form of PBR is to provide for multiyear rate plans, where the incentive between rate cases is to achieve designated policy goals. Specific rewards for achievement provide higher earnings between proceedings, rather than mere cost control. This may have the effect of extending the period between general rate proceedings, making it more important that cost allocation in rate proceedings be given adequate attention. This is important because the results may be in place for a longer period than with conventional regulation.

### 7.2.4 Trackers and Riders

The rapid proliferation of tariff riders did not feature in the 1992 NARUC cost allocation manual at all. The earliest of these were **fuel adjustment clauses** adopted in the wake of the oil embargos in the 1970s, but they have now spread to many other categories, including energy efficiency programs, infrastructure spending, nuclear decommissioning and taxes. These riders cause revenue levels to track changes in costs between rate cases in specific categories. Some utilities have 10 or more separate tariff riders, each adjusted between rate cases.

Cost of service studies should be designed for compatibility with the methods that will be used to adjust costs between rate cases. Adjustments between cases may need to be simpler for administrative convenience and may not track cost study results accurately. To maintain consistency, the cost of service study may allocate all costs, with costs to be recovered through riders netted from class revenue requirements as the final step before the design of base rates. Alternatively, allocations of particular cost components from the cost of service study can be applied to the allocation of rider costs (e.g., the residential class might be assigned 34% of any primary distribution upgrades, 30% of purchased renewable energy, and so on).

<sup>71</sup> For example, in 1980, the Washington State Legislature approved a 2% incremental rate of return for energy efficiency investments. Two decades later, the Nevada Public Utilities Commission adopted a similar incentive. Both have been allowed to expire.

<sup>72</sup> For example, an incentive mechanism to control fuel costs may require capital investments to improve generating units.

Many tariff riders recover only the difference between actually incurred costs and costs estimated in a rate case, which could be reasonably expected to be relatively small. As a result, it often seems relatively fair and administratively efficient to pass these costs on in a simple way. Larger costs may require more detailed methods to track the broader issues laid out in this manual. If general rate cases occur with reasonable frequency, the divergence of riders from the cost of service study between general rate cases probably will be minor.

Many riders are allocated to classes on one of two simple models: a uniform cents-per-kWh surcharge or a uniform percentage surcharge. The uniform cents-per-kWh approach is appropriate for costs associated or correlated with energy usage. The percentage surcharge is rarely appropriate, since it will allocate costs proportionate to all the rate case costs, from meters to substations to (for vertically integrated utilities) baseload generation.

A wide variety of costs are routinely recovered through riders and trackers in many jurisdictions. These costs include the following.

*Fuel and purchased power:* Historically, most of these costs have been recovered through rate riders on a uniform cents-per-kWh basis across all classes.<sup>73</sup> Various fuels and purchased resources (renewables, combined cycle plants, combustion turbines, storage resources) provide different mixes of services. It may be appropriate to unbundle these costs by time period, so that charges more accurately reflect the hours in which the resource is useful and hence the mix of customer loads that use it. The typical uniform cents-per-kWh fuel adjustment clause may be replaced by a more granular rider, with at least time and seasonal differentiation (Hledik and Lazar, 2016). To the extent feasible, the allocation of costs in the rider should reflect the approach used in the general rate proceeding. If costs associated with purchased power are not separated between base rates and the adjustment mechanism in the same manner as utility-owned generating assets, a double-recovery problem may occur, with base rates recovering hypothetical investment costs to serve load growth, while an adjustment mechanism also recovers these costs.

*Decoupling and weather normalization:* Many regulators

have adopted measures to insulate utility net income from variations in sales volumes. Some of these mechanisms are decoupling adjustments that take all sales variations into account, while others are strictly limited to sales variation due to energy conservation program deployment or weather. Most of these mechanisms adjust costs that are included in the cost allocation study at test-year levels. The allocation method used for these riders between rate cases should reflect the allocation of costs in the general rate cases. For example, customer costs do not vary with sales levels and should not be used in allocating the costs and credits from weather normalization.

*Required and approved new projects:* Some jurisdictions allow utilities to adjust rates to reflect new investments or operating costs (perhaps limited to specific categories, such as pollution control equipment, storm protection or ISO-approved transmission). The method used to allocate changes in costs between rate cases should be consistent (even if simplified) with the method used to allocate costs in general rate cases.

*Inflation and actuarial changes:* A few states allow flow-through between rate cases of inflation, attrition, statutory tax rates or other exogenous changes in costs, such as labor contracts or pensions. Where possible, these adjustments should be allocated in a manner similar to that used for the underlying costs.

*Flow-through of changes in property taxes:* Property taxes affect all elements of service and are generally assessed on the basis of appraised value, which (depending on the jurisdiction) may be very different from the gross and net book values used to set the revenue requirement.

*Flow-through of municipal taxes and franchise fees:* Some gross revenue taxes and franchise fees are imposed by municipalities and are often directly assigned to customers in that municipality and collected on the same basis they are imposed (e.g., a uniform percentage of gross revenue).

*Storm damage:* Regulators often allow recovery for storm damage in proceedings separate from general rate cases. In many cases, balancing accounts are created for

---

73 Some utilities adjust power supply riders by estimated line losses by class.

storm damage recovery; after large storms, the amount to be recovered may be adjusted. Storm damage typically affects primarily distribution and transmission costs. The method used for apportionment of changes in tariff riders for storm damage should generally follow the methods used in rate cases for apportioning the relevant costs (but not the cost for unaffected T&D costs, such as meters in most storms).

*Regional transmission charges:* Transmission charges imposed by an RTO or ISO are subject to change between rate cases. These changes may flow through to customers through a broader generation-cost tracking mechanism or a separate transmission rider. To the extent feasible, the costs should be classified and allocated using the same approaches used in allocating bulk transmission costs in the cost of service study. Because peaking assets commonly are located inside or near load centers, bulk transmission requirements tend to be driven more by access to low-cost energy resources, such as baseload generation, as discussed in Chapter 10. If some simple allocator is required for transmission costs outside full rate reviews, an energy allocator is likely to be reasonable.

*Earnings sharing mechanisms:* Some states require utilities to share earnings that exceed some threshold above the allowed rate of return; these are common in conjunction with decoupling mechanisms. Because overall earnings are a broad measure of utility costs compared with revenues, any earnings sharing will likely be spread across all functional areas and should be reflected as a percentage adjustment to overall rates.

## 7.2.5 Public Policy Discounts and Programs

Regulators and legislatures have dictated that utilities offer a range of public policy programs, mostly falling into two categories: (1) discounts or surcharges for certain categories of customers, such as low-income discounts, economic development discounts for industrial customers and area-specific surcharges; and (2) resource-specific incentives for energy efficiency, storage and renewables (including distributed solar).

These programs result in additional costs or redirected revenue requirements to be recovered through base

rates, riders or a combination of the two. These revenue requirements may be included in the allocation of total costs, with base rates set to exclude the revenues expected through the riders, or the base rate revenue requirements and the riders can be allocated separately. In any case, the revenue requirements should be allocated among classes in a manner consistent with causality or benefits, without creating excessive administrative burdens in the updating of riders.

Public policy programs for specific resources or resource types (a renewable portfolio standard or other types of clean energy standard) may be justified on current economic benefits, environmental benefits, reliability improvements or the acceleration of emerging technologies and industries with future potential benefits. The costs of these programs are usually allocated either on the basis of program participation by rate class or in proportion to system benefits as they are expected to accrue across rate classes.

## 7.2.6 Consideration of Differential Rates of Return

Historically, most cost allocation studies have applied a single rate of return, based on the utility cost of capital, to all capital investment components of the system and to all customer classes. In a more competitive utility environment, this may no longer be appropriate.

Rating agencies and others recognize some utility assets, such as generation, as riskier than other assets, such as distribution. Many utilities have experienced significant disallowances in cost recovery for generation, but the same generally has not been the case with distribution investment. Applying a function-specific rate of return in computing class cost responsibility will assure that this cost follows causation and benefit.

Similarly, some utility customer classes may be viewed as riskier than others. This may be customers with electric space conditioning, whose usage is more temperature-sensitive, creating variability in sales from year to year. Or it may be entire classes of customers whose usage varies with economic conditions, creating what financial analysts call systematic risk that raises the utility cost of capital. Applying a class-specific rate of return in computing class cost responsibility

will ensure that low-risk classes do not pay costs more properly attributable to higher-risk classes.

A differential rate of return can be reflected either by assigning different costs of equity and debt to higher- and lower-risk parts of the enterprise, or by assigning a less-leveraged capital structure to the riskier parts of the enterprise and a more leveraged capital structure to the lower-risk parts. Moody's Investor Service applies a higher "business risk" score to generation than to distribution plant. This is then reflected in a higher equity capitalization rate, and thus a higher rate of return requirement, for generation plant (2017, p. 22). This translates into a differential rate of return requirement by customer class because different customer classes use a different mix of generation and distribution assets relative to their total revenue.

### 7.2.7 Stranded Costs, Changed Purposes and Exit Fees

Regulators will face several challenging issues as technology evolves in the electric power industry. Among these will be issues of stranded costs and changing purposes of past investments. Stranded costs occur when an asset is retired prior to being fully depreciated or when an asset is sold at a market price that is below the level included in rate base. Stranded costs were quite significant when the telecommunications industry evolved to computer switching and digital transmission after restructuring in the 1990s and 2000s. The issues will be at least as significant regarding the retirement of current coal and nuclear units. But some assets will be redeployed; for example, coal plant sites that formerly operated as baseload resources may be repurposed to support gas-fired peakers. Transmission lines originally built to serve remote baseload power plants may be redeployed to bring variable renewable energy. These changes to asset usage will raise unique cost allocation issues.

#### Generation

Historically, the largest source of stranded costs in the electric industry has been baseload generating resources. Tens of billions of dollars were invested in nuclear units that were abandoned prior to completion in the early 1980s. Many of the

**Figure 29. Projections for US coal generating capacity**

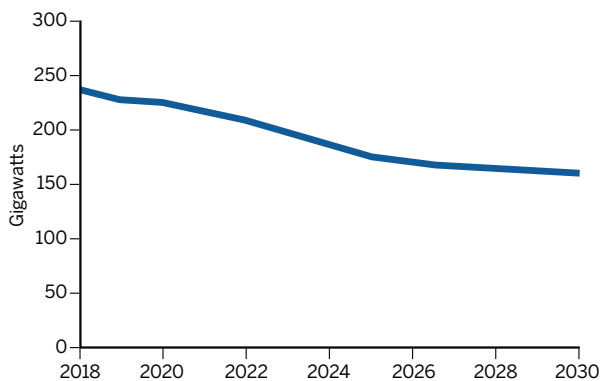

Source: U.S. Energy Information Administration. (2019). *Annual Energy Outlook 2019*

nuclear plants that were completed closed long before they were fully depreciated, due to severe damage (e.g., TMI 2, Crystal River, Trojan, Rancho Seco and San Onofre), large investment requirements or unfavorable economics. Today, innovation is rendering many units uneconomic in a narrow financial sense, excluding externalities of any kind, even when they are still mechanically sound. As shown in Figure 29, the U.S. Energy Information Administration (2019) projects that nearly 100 GWs of coal generation will be retired between 2018 and 2030. Most of this is due to economic obsolescence, but it also reflects changing public policies around air pollution and climate.

Economic obsolescence of coal plants is primarily a result of lower-cost wind, solar and natural gas.<sup>74</sup> Although some policymakers are considering whether these coal plants, or the broader coal industry, need to be supported with financial incentives, there has been widespread support for this coal retirement trend for both cost and environmental reasons. In contrast, many states have been implementing policies to slow or stop nuclear retirements, in part because of the plants' climate benefits. In many cases, regulators have been actively involved in the decision to retire these units through integrated resource planning processes. In some

<sup>74</sup> Public Service Company of Colorado decided to retire two coal units at the Comanche generating facility in Pueblo after bids for wind and solar energy were so low that the operating costs of these coal plants were deemed uneconomic (Pyper, 2018).

cases, legislatures have driven the retirements. Although a retirement usually concludes with a regulatory determination of what part of the cost is recoverable, a separate decision must be made on how to reflect the allowed costs in the cost of service methods and rate design of the utility.

Cost allocation analysts are not typically charged with determining the portion of abandoned project costs that electricity consumers or shareholders should bear. However, if these costs are included in rates, analysts are charged with determining how to reflect those costs in utility cost allocation studies and ultimately in rate design. If the plants were allocated in one way when operating and that method changes after termination, then the costs are shifted from one set of customers to another.

In other circumstances, plants have been converted from their original purpose to different purposes. The most common of these are baseload units, originally built to provide year-round service, being converted to peaking or seasonal generation or held in reserve for droughts or other contingencies. The cost allocation framework for the new purpose may be fundamentally different from the historical method based on historical usage.

In all of these cases, the cost of service study must reflect the allowed costs for abandoned or repurposed units. Should the costs be allocated based on the original intended purpose? Or should these costs be allocated based on the last useful purpose for the units? There is no easy answer.

Similar issues arose from the divestment of generation assets during restructuring. In jurisdictions with restructured utilities,<sup>75</sup> millions of retail customers have begun taking generation services from retail electricity providers or public aggregators and no longer pay the regulated utility directly for power supply. In many cases, this was politically achievable only by providing a method to compensate the

utility for any stranded costs. This compensation typically was accomplished through a nonbypassable per-kWh charge on all distribution system customers, although in some cases specific exit fees were established so that departing customers made a one-time lump sum payment. Often this was done without reference to how the underlying costs are allocated among classes.

During restructuring proceedings in New England, many of the mid-Atlantic states, Illinois and Texas, regulators used an incremental valuation approach to recover the difference between the embedded costs and market values of generation assets. This included:

1. The net plant for utility-owned generation minus the sales price for those assets. That difference was negative for most hydro and fossil assets and positive for most nuclear assets.<sup>76</sup>
2. Costs of decommissioning for retired plants, especially nuclear units.
3. Payments to terminate or restructure long-term power purchase agreements.
4. Profit or loss from operating any residual utility-owned generation and selling power into the competitive market.<sup>77</sup>
5. Annual differences between payments for continuing power purchase agreements and the value of the power in the capacity and energy markets.<sup>78</sup>

Stranded cost charges are set to recover the sum of categories 4 and 5, the amortization of the balances in categories 1 through 3, any carrying charges for unamortized balances and any over- or undercollections in earlier periods.<sup>79</sup> Categories 4 and 5, and hence the overall surcharge, may be positive or negative. The surcharge continues until the stranded capital costs are recovered (or gains distributed) and all continuing cash flows end. In some jurisdictions,

75 New York, New Jersey, Pennsylvania, Maryland, Delaware, the District of Columbia, Ohio, Illinois, California, Texas and most of New England, as well as some customers in Michigan and Oregon. In Canada, Ontario has restructured similarly.

76 Certain utilities, notably all those in Ohio and some in Pennsylvania, New Jersey and Maryland, were allowed to transfer their generation assets to an affiliate at an estimated market value, rather than imposing a true market test from full divestment.

77 This approach has been applied to generation for which sale has been delayed (e.g., several nuclear units) or is impractical (e.g., ConEd's generation units located at or serving its steam distribution system) and to resources, such as renewables, that the utility is allowed to develop.

78 Long-term wholesale sales agreements may be bought out or treated in the same manner as power purchase agreements.

79 The costs in the first three categories frequently were refinanced through low-risk bonds, in a process called securitization.



restructuring surcharges have continued into 2019, in some cases as a credit.

Lastly, **community choice aggregation** has raised a similar set of issues in California, in part because a choice of energy supplier is not allowed more generally, and the utilities have procured long-term supply resources for a variety of reasons. Locales that form community choice aggregators, primarily counties, are allowed to contract directly with generators for power supply, which may vary from the resource characteristics of the utility's standard supply. In the meantime, market supply costs have declined, especially for renewables, and the migration of customer generation requirements from the utility to the aggregators can result in some stranded power costs, at least according to the utilities. California has selected a complex solution, imposing a power charge indifference adjustment, a type of exit fee with annual updates, on the community choice aggregators to recover the difference between actual utility costs and market prices. Rather than having a single charge for all customers to cover above-market costs, California has created a highly controversial process to set a charge for the customers of the aggregators and the direct marketers. The California experience illustrates the benefits of consistent allocation across customers, as opposed to the development of special rates for special groups of customers.

Any charge for stranded assets or costs should be temporary, only until the specific costs regulators allow are recovered.

### **Transmission**

There is less history with transmission abandoned costs, but many lines are now being repurposed. Originally they were built to connect distant coal or nuclear baseload generating resources to urban load centers. Many of these were classified and allocated in the same manner as the baseload generation, with at least a portion of the cost classified as demand-related and allocated on some measure of peak demand. Today, with new natural gas generation being sited close to load centers and older coal and nuclear baseload units retired, these lines are being repurposed to transport economic energy from distant markets, including

opportunity purchases, or to carry power from new wind and solar generating resources.<sup>80</sup> This is a very different use and provides very different economic benefits to consumers.

Some transmission lines are disused due to generation retirement. Although the inclusion of these costs in the rate base of the owning enterprise is a revenue requirement issue, the classification and allocation of any cost allowed by the regulator is a cost allocation issue. Some transmission lines may become economically obsolete due to the deployment of DERs within the service territory, obviating the need for some distant generation and its associated transmission lines. In this situation, the rate analyst is faced with the question of how to classify and allocate the fully or partly stranded costs.

Some lines may be repurposed from providing firm service from baseload resources to providing seasonal economic service without a clear connection to peak demand. In this situation, the costs may still be fully justified as economic and in the public interest, but a change in allocation method may be justified. An hourly assignment method will ensure that these costs are recovered in the hours when the economic energy is flowing.

### **Distribution**

There have been very few regulatory disallowances of any magnitude for distribution plant, in part because the mass accounting methods do not identify specific segments. For example, when a large industrial facility closes, the investment in distribution facilities serving it typically remains in the regulated revenue requirement and continues to be classified and allocated in traditional ways. But technological evolution may result in higher rates of retirement or repurposing.

Some assets will be disused at many hours, due to deployment of DERs. Some CHP facilities will be entirely self-sufficient much of the time, with reliance on grid-supplied energy only during maintenance outages or periods of economical options. Distribution lines originally designed

---

<sup>80</sup> Clear examples of this are found in the desert Southwest, where retirement of coal units in New Mexico, Arizona and Utah that formerly served California utilities is freeing up transmission that is being repurposed for moving variable renewables. State legislation mandated the retirements; economic conditions are driving the repurposing of these facilities.

to provide continuous service may be used only for a limited number of hours. The rate analyst must consider which is appropriate: applying the same methods used before DERs were installed or a different classification and allocation method in light of the changed circumstances.

In some areas of Hawaii, distribution circuits are back-feeding to the transmission system at midday; these lines are now serving a power supply integration function for many hours of each day.

The flow may be bidirectional. Power will flow into the lines from distant generation or storage during hours of darkness and into the grid for redelivery during high solar hours. The cost may be entirely prudent, but the traditional allocation methods may not accurately assign costs to the beneficiaries. An hourly allocation method may be appropriate for these circumstances, with the costs flowing to

the consumers actually using the power when it is generated, rather than being apportioned to the generators or to customers not receiving power at certain hours.

### **Cross-Functional Repurposing**

There are myriad examples of utility resources once needed for a particular function being repurposed for an entirely different function. For example, a former power plant site may become a location for a distribution warehouse. The power plant was functionalized as generation and allocated based on demand and energy factors. The distribution warehouse is a component of general plant, and the allocation method may be very different. One challenge for the rate analyst is tracking changes in how assets are being used, to keep the allocation framework consistent with the utilization of the assets.

## 8. Choosing Appropriate Costing Methods

In general, facilities shared among multiple users, as well as expenses and investments benefiting all ratepayers, should be apportioned based on measures of shared usage. Facilities that are uniquely serving individual customers should be sized to their individual needs, and the costs should be directly associated with those customers. Overhead costs, such as A&G expenses and general plant,

are not costs that are subject to a “technically correct” allocation.<sup>81</sup> Pragmatically, these costs can be fairly divided among classes based on a measure of usage or even revenue since there is not necessarily a link between system cost drivers and these costs.

The first task in choosing a cost allocation method is to ascertain the objective of the study: Is it focused on short-run

### Many factors influence cost allocation method selection

The appropriate choice of a detailed allocation approach and the most appropriate method may be affected by such factors as:

- Are the utility’s loads growing, shrinking or stagnant?
- Does the utility have a mix of different types of supply resources to serve varying load levels?
- Does the utility rely on transmission facilities to deliver power from remote baseload, hydro or renewable energy resources?
- Is generation mostly spread among load centers, or is supply concentrated within certain portions of the service territory?
- Does the utility’s supply mix include variable renewable resources, such as wind and solar?
- Does the utility have sufficient load density to support the distribution system with energy sales, or is the load so sparse that other revenues are required to pay for distribution (as is the case for some cooperatives)?
- Are peaking resources located inside the service territory near loads, or are they dependent on transmission from distant sources?

- How do the utility’s customers break down into classes and subclasses that have significantly different cost characteristics?
- Does the utility have reasonably reliable hourly load data, by class?
- Does the utility have demand response resources that can help meet extreme peak requirements?
- Does the utility have storage resources that can shift generation or loads among time periods?
- Does the utility’s load peak in the winter, in the summer or both?
- Do different customer classes peak at different times of the day or different seasons of the year?

Each of these questions bears on the most appropriate cost allocation approach. A mix of resources requires a method that appropriately treats that variety of resources differently in classification and allocation. Variable resources require a method that assigns their costs to the hours in which they produce benefits. The location of supply resources determines whether the method must apportion transmission costs among multiple purposes.

<sup>81</sup> Bonbright described some distribution costs as strictly unallocable: “But if the hypothetical cost of a minimum-sized distribution system is properly excluded from the demand-related costs for the reason just given, while it is also denied a place among the customer costs for the reason stated previously, to which cost function does it then belong? The only defensible

answer, in my opinion, is that it belongs to none of them. Instead, it should be recognized as a strictly unallocable portion of total costs. And this is the disposition that it would probably receive in an estimate of long-run marginal costs” (1961, p. 348). The same “unallocable” characteristic may apply to other system costs in an evolving industry.

equity considerations or rather on efficiency considerations? Is the system an optimal system or a suboptimal system for today's needs? Most advocates of using embedded cost studies point to the direct link with the revenue requirement and spreading that revenue requirement among multiple customers. Although there is a wide range of embedded cost methods, all of them apportion the existing revenue requirement, and rates based on the results should produce the allowed amount of total revenue.

Within this broad sense of equity, however, the methods selected may result in vastly different results. For example, in one docket, the Washington Utilities and Transportation Commission considered the results of several approaches to embedded cost of service studies, presented by the utility, the commission staff and intervenors. The commission did not rigorously follow any of them but found that the range of these studies defined an appropriate range in which the revenue allocation should be based.

Another goal of cost allocation is long-run efficiency to guide consumer consumption based on where costs are going, not where they are.<sup>82</sup> The use of long-run marginal costs attempts to do this in the cost allocation phase of rate-making, and indeed this was the position that some advocates took in the hearing era after passage of PURPA. Their position was that all costs should be forward-looking to encourage long-run efficiency and that past costs cannot be "saved," so there is no point using them for cost allocation or rate design.

But marginal costs are not the same as current costs making up the revenue requirement, and some method is needed to reconcile (up or down) the results of a marginal cost study with the revenue requirement. The methods to do this include proportionality (adjusting all class revenue requirements by the same percentage) and various methods of focusing on certain aspects of cost in adjusting allowed revenues in consideration of marginal cost. These methods have been highly controversial, as discussed in detail in Part III.

In the short run, it is desirable to optimize the incurrence of variable costs such as fuel, labor and purchased energy. Consideration of short-run marginal costs focuses on exactly this. If systems have excess generating capacity, power costs

are low; with deficient capacity (or fuel or water shortages), power costs are high. One problem with establishing cost allocation on the basis of short-run marginal costs is that few costs other than power supply vary significantly in the short run. Although utilities do reduce staffing during a recession and may defer maintenance, these are minor cost savings. Therefore, the costs considered are only a very small fraction of the revenue requirement.

During periods of energy shortage, such as the California energy crisis of 2000-2001, regulators may believe that short-term deviations from traditionally used long-run marginal cost theory are appropriate. In California's case, the commission approved both higher thresholds for energy efficiency investments and very sharply increased tailblock rates.

One issue that has been raised with respect to various short-run and NERA-style marginal cost studies is that they capture only a limited window in time, when utility resources may be imperfectly matched to utility customer needs. This is discussed in detail in Part IV.

A market that has short-run marginal costs that are equal to long-run marginal costs is said to be in equilibrium. When in equilibrium, the cost of producing one more unit of output with existing resources is relatively expensive, because all of the low-cost resources are already fully deployed, resulting in short-run costs that exactly match the cost of building and operating new resources. For electric generation, this might mean running a peaker to provide energy in many hours because available lower-cost units are fully deployed. In this situation, there would be no difference between marginal cost studies using different time horizons.

But electric utilities are almost never in equilibrium, for several reasons:

- Forecast and actual loads, costs, technologies and resource availability change faster than the system can be reconfigured, leaving systems with capacity excess or deficiency and resources that are poorly suited to current needs.
- Utilities maintain reserve margins for reliability, which often results in energy dispatch costs that are lower than

<sup>82</sup> Canadian hockey great Wayne Gretzky is widely quoted as having said: "I skate to where the puck is going to be, not where it has been."

the fixed and variable costs of a new efficient generating unit. A system with marginal running costs high enough to justify new construction will tend to have a relatively low reserve margin.

- In other markets, short-run costs can be allowed to rise, with the tightening available supply rationed by pricing, and the short-run cost becomes the price of outbidding other users. For electricity, that approach would lead to blackouts.
- Transmission and distribution do not have short-run marginal costs comparable to the long-run costs of new equipment. Short of allowing overloads until lines and transformers fail, there is no way to bring a T&D system into equilibrium.
- As energy generation transitions from fossil generation with high running costs to zero-carbon resources with low running costs and high capital costs, it will be harder to match short-run and long-run costs.

A state of disequilibrium can severely affect some customer classes if a marginal cost study is based on short- to medium-term costs. If a shortage of power supply exists, it

will severely affect large-volume customer classes; if a surplus exists, it will severely affect residential and small commercial customers.

In the following chapters, we address in detail how each type of cost should be considered in different approaches to cost allocation. The methods will be different for every utility because every utility has a different history and a different mix of resources, loads, costs, issues and opportunities. The appropriate method for each utility may be slightly different. It is driven by the mix of customers, the nature of the service territory, the type of resources employed and the underlying history that guided the evolution of the system. No single method is appropriate for every utility, and no single method is likely to produce a noncontroversial result. Many regulators will seek consistent methods to be applied to all utilities in their state, which may require compromise from the most appropriate method for each individual utility. In Chapter 27, we discuss how regulators can use the results of quantitative cost studies to actually determine a fair allocation of costs among classes.

## Works Cited in Part II

- Austin Energy (2017). *Residential electric rates & line items* [Webpage]. Retrieved from <https://austinenenergy.com/ae/rates/residential-rates/residential-electric-rates-and-line-items>
- Bonbright, J. (1961). *Principles of public utility rates*. New York, NY: Columbia University Press.
- Bureau of Reclamation. (1991). *Permissible loading of oil-immersed transformers and regulators*. Denver, CO: Author. Retrieved from [https://www.usbr.gov/power/data/fist/fist1\\_5/vol1-5.pdf](https://www.usbr.gov/power/data/fist/fist1_5/vol1-5.pdf)
- California Public Utilities Commission. (n.d.). *Net energy metering (NEM)* [Webpage]. Retrieved from <https://www.cpuc.ca.gov/general.aspx?id=3800>
- California Public Utilities Commission. (2016, January 28). *Decision adopting successor to net energy metering tariff*. Decision No. 16-01-044. Retrieved from <http://docs.cpuc.ca.gov/PublishedDocs/Published/G000/M158/K181/158181678.pdf>
- Denholm, P., Margolis, R., and Milford, J. (2008). *Production cost modeling for high levels of photovoltaics penetration* (TP-581-42305). Golden, CO: National Renewable Energy Laboratory. Retrieved from <https://www.nrel.gov/docs/fy08osti/42305.pdf>
- Electric Reliability Council of Texas. (2019). *2018 ERCOT hourly load data* [Data set]. Retrieved from [http://www.ercot.com/gridinfo/load/load\\_hist/](http://www.ercot.com/gridinfo/load/load_hist/)
- Federal Energy Regulatory Commission. (n.d.). *Form No. 714 — Annual balancing authority area and planning area report* [Webpage]. Retrieved from <https://www.ferc.gov/docs-filing/forms/form-714/data.asp>
- Federal Energy Regulatory Commission. (1979, September 28). *Order 48: Final regulations in Docket RM79-6*. Retrieved from [https://elibrary.ferc.gov/idmws/file\\_list.asp?document\\_id=14005118](https://elibrary.ferc.gov/idmws/file_list.asp?document_id=14005118)
- Flex-Core. (n.d.). *Energy metering using potential and current transformers* [Webpage]. Retrieved from <https://www.flex-core.com/engineering-resources/application-whitepapers/energy-metering-using-potential-current-transformers/>
- Hawaiian Electric Company. (2014, April 30). *Minimum day time load calculation and screening*. Distributed Generation Interconnection Collaborative (DGIC) webinar. Retrieved from [https://www.energy.gov/sites/prod/files/Hawaiian%20Electric%202014-04-30\\_minimum-day-time-load-calculation-and-screening.pdf](https://www.energy.gov/sites/prod/files/Hawaiian%20Electric%202014-04-30_minimum-day-time-load-calculation-and-screening.pdf)
- Hledik, R., and Lazar, J. (2016). *Distribution system pricing with distributed energy resources*. Golden, CO: Lawrence Berkeley National Laboratory. Retrieved from <https://www.osti.gov/servlets/purl/1375194>
- Hogan, M. (2016). *Hitting the mark on missing money: How to ensure reliability at least cost to consumers*. Montpelier, VT: Regulatory Assistance Project. Retrieved from <https://www.raonline.org/knowledge-center/hitting-mark-missing-money-ensure-reliability-least-cost-consumers/>
- International Telecommunication Union. (2009). *Regulatory accounting guide*. Retrieved from [https://www.itu.int/ITU-D/finance/Studies/Regulatory\\_accounting\\_guide-final1.1.pdf](https://www.itu.int/ITU-D/finance/Studies/Regulatory_accounting_guide-final1.1.pdf)
- Kahn, A. (1970 and 1971). *The economics of regulation: Principles and institutions* (vols. 1 and 2). New York, NY: John Wiley & Sons.

- Lazar, J. (2016). *Teaching the “duck” to fly* (2nd ed.). Montpelier, VT: Regulatory Assistance Project. Retrieved from <https://www.raponline.org/knowledge-center/teaching-the-duck-to-fly-second-edition/>
- Lazar, J., and Baldwin, X. (2011). *Valuing the contribution of energy efficiency to avoided marginal line losses and reserve requirements*. Montpelier, VT: Regulatory Assistance Project. Retrieved from <https://www.raponline.org/knowledge-center/valuing-the-contribution-of-energy-efficiency-to-avoided-marginal-line-losses-and-reserve-requirements/>
- Lefkowitz, K. (2016, April). Direct testimony on behalf of Potomac Electric Power Co. (Pepco). *Application of Potomac Electric Power Co. for adjustments to its retail rates for the distribution of electric energy* (Vol. 1). Maryland Public Service Commission Case No. 9418. Retrieved from <https://www.psc.state.md.us/search-results/?keyword=9418&x.x=34&x.y=18&search=all&search=case>
- Moody’s Investor Service. (2017, June 23). *Rating methodology, regulated electric and gas utilities*.
- National Association of Regulatory Utility Commissioners. (1992). *Electric utility cost allocation manual*. Washington, DC: Author. Retrieved from <https://pubs.naruc.org/pub/53A3986F-2354-D714-51BD-23412BCFEDFD>
- National Economic Research Associates. (1977). *A framework for marginal cost-based time-differentiated pricing in the United States*. Palo Alto, CA: Electric Power Research Institute.
- New York Public Service Commission. (2017, March 9). *Order on net energy metering transition, Phase One of value of distributed energy resources, and related matters*. Case No. 15-E-0751. Retrieved from <http://documents.dps.ny.gov/public/Common/ViewDoc.aspx?DocRefId={5B69628E-2928-44A9-B83E-65CEA7326428}>
- Nicholas, M., and Hall, D. (2018). *Lessons learned on early electric vehicle fast-charging deployments*. Washington, DC: The International Council on Clean Transportation. Retrieved from [https://www.theicct.org/sites/default/files/publications/ZEV\\_fast\\_charging\\_white\\_paper\\_final.pdf](https://www.theicct.org/sites/default/files/publications/ZEV_fast_charging_white_paper_final.pdf)
- Potter, J., George, S., and Jimenez, L. (2014). *SmartPricing options final evaluation*. Sacramento, CA: Sacramento Municipal Utility District. Retrieved from [https://www.smartgrid.gov/files/SMUD-CBS\\_Final\\_Evaluation\\_Submitted\\_DOE\\_9\\_9\\_2014.pdf](https://www.smartgrid.gov/files/SMUD-CBS_Final_Evaluation_Submitted_DOE_9_9_2014.pdf)
- Pyper, J. (2018, August 29). Xcel to replace 2 Colorado coal units with renewables and storage. *Greentech Media*. Retrieved from <https://www.greentechmedia.com/articles/read/xcel-retire-coal-renewable-energy-storage>
- Rissman, J. (2017). *The future of electric vehicles in the U.S.* San Francisco, CA: Energy Innovation. Retrieved from [https://energyinnovation.org/wp-content/uploads/2017/10/2017-09-13-Future-of-EVs-Research-Note\\_FINAL.pdf](https://energyinnovation.org/wp-content/uploads/2017/10/2017-09-13-Future-of-EVs-Research-Note_FINAL.pdf)
- Seattle City Light. (n.d.). *City Light rates: Tariffs and rules* [Webpage]. Retrieved from <https://www.seattle.gov/light/rates/ratedetails.asp>
- Shirley, W. (2001). *Distribution system cost methodologies for distributed generation* (Vol. 2, Appendices). Montpelier, VT: Regulatory Assistance Project. Retrieved from <https://www.raponline.org/knowledge-center/distribution-system-cost-methodologies-for-distributed-generation-volume-ii-appendices/>
- Slusarewicz, J., and Cohan, D. (2018). Assessing solar and wind complementarity in Texas. *Renewables: Wind, Water and Solar* (5)7. Retrieved from <https://jrenewables.springeropen.com/articles/10.1186/s40807-018-0054-3>
- Trabish, H. (2017, November 2). In new trend, utilities propose separate rate classes for solar customers without rate increase. *Utility Dive*. Retrieved from <https://www.utilitydive.com/news/in-new-trend-utilities-propose-separate-rate-classes-for-solar-customers-w/508393/>

U.S. Department of Energy. (n.d.). *Charging at home* [Webpage]. Retrieved from <https://www.energy.gov/eere/electricvehicles/charging-home>

U.S. Energy Information Administration. (2019). *Annual energy outlook 2019*. Table 9. Washington, DC: Author. Retrieved from <https://www.eia.gov/outlooks/aeo/data/browser/#/?id=9-AEO2019&cases=ref2019&sourcekey=0>

Vermont Public Service Board. (2007, June 20). *Investigation into least-cost integrated resource planning for Vermont Electric Power Company's transmission system*. Docket No. 7081. Retrieved from <https://epuc.vermont.gov/?q=node/104/16200>

Vermont System Planning Committee. (n.d.). *Planning for the future of Vermont's electric power grid* [Webpage]. Retrieved from <https://www.vermontspc.com/>

Wood Mackenzie Power & Renewables and Solar Energy Industries Association. (2019, March). *U.S. solar market insight*. Retrieved from <https://www.seia.org/research-resources/solar-market-insight-report-2018-year-review>



# **Part III: Embedded Cost of Service Studies**

## 9. Generation in Embedded Cost of Service Studies

This chapter addresses the allocation of generation costs, including investment-related costs, operation and maintenance costs and fuel costs. As noted in Section 6.1, equivalent changes in the allocation of a cost category among classes can be achieved by changing functionalization, classification or the choice of allocation factor.<sup>83</sup> That section discusses the relevant issues at a high level, and this chapter delves more deeply into the underlying concepts and analytical techniques.

This chapter is not generally relevant to cost allocation for utilities that have restructured and no longer procure generation resources, as long as the generation prices suppliers offer (directly to customers or to the utility for default service) are differentiated by rate class. High-level cost allocation issues with respect to generation and default service are discussed in Section 7.2.

As discussed in Chapter 3, utilities acquire and maintain different types of generation resources, with distinct operating capabilities, to meet a range of needs including low-cost energy, reliability, **load following** and environmental compliance. Different classification and allocation methods may be necessary to equitably allocate the costs of different types of generation resources. In more recent years, energy efficiency, expanded demand response, distributed generation and energy storage — all of which can be located where load relief is most valuable — have expanded the utility's options to meet load growth or reduce demands on aging assets without building transmission, distribution or central generation facilities.

Fuel costs, purchased power and dispatch O&M costs, such as the short-run variable cost of pollution controls, are typically classified as energy-related. The other categories of generation costs have generally been classified as being driven by some combination of energy (total energy requirements to serve customers, plus losses) and demand (some measure of loads in the hours that contribute to concerns about the

adequacy of generation supply to meet loads). Energy use is sometimes broken into TOU periods, so that different types of costs are spread over the hours in which they are used, as discussed further in Section 9.2 and Chapter 17.

When there are multiple cost-based approaches for estimating a classification or allocation factor, a compromise among the results may be appropriate. For example, various measures of reliability risk (emergency purchases, operation of peakers, interruption of load, inadequate operating reserve) may be distributed differently across the months, and the regulator may reasonably select a generation demand allocator averaging across the results of those measures. Similar conditions might apply for varying estimates of the firm-capacity equivalent for wind plants or other inputs.

Some cost of service studies identify other classifications of generation costs, such as ancillary services. These components are generally very small compared with total generation costs, and some ancillary services (automatic generation control, black start capability, uplift) can be difficult to relate to class load characteristics.

### 9.1 Identifying and Classifying Energy-Related Generation Costs

Many regulators have recognized that energy needs are a significant driver of generation capital investments and nondispatch O&M costs. In modern utility systems, generation facilities are built both to serve demand (i.e., to meet capacity and reliability requirements) and to produce energy economically. The amount of capacity is largely determined by reliability considerations, but the selection of generation technologies and thus the cost of the capacity are

---

<sup>83</sup> As mentioned previously, the third step is usually called allocation, which is the same as the name of the entire process. Some analysts refer to this third step as factor allocation in an attempt to prevent confusion.

largely determined by energy requirements.<sup>84</sup> For variable renewables, particularly wind and solar, the effective capacity (in terms of the reliability contribution) of the generators is much smaller than their nameplate capacity, and the costs are mostly undertaken to provide energy without fuel costs or air emissions. Energy storage systems provide both energy benefits (by shifting energy from low-cost to high-cost hours) and reliability benefits, while demand response is used primarily to increase reliability.

As discussed in the text box on pages 78-79, some older cost of service studies classified a wide range of capital and nondispatch O&M costs as demand-related on the grounds that the costs were in some manner fixed, without regard for cost causation. This approach, known as **straight fixed/variable**, is anachronistic and does not reflect cost causation.<sup>85</sup>

Table 12 shows the capital and O&M costs estimated for new conventional generation units from the 2018 Lazard's *Levelized Cost of Energy Analysis* report.<sup>86</sup> Although the original costs and current plant in service and O&M costs of older units will vary, the general relationships have been consistent.

This section first discusses the insights on this issue

**Table 12. Cost components of conventional generation, 2018 midpoint estimates**

Technology	Capital cost (per kW)	Fixed operations and maintenance (per kW-year)	Variable operations and maintenance (per MWh)
<b>Combustion turbine</b>	\$825	\$12.50	\$7.40
<b>Combined cycle</b>	\$1,000	\$5.75	\$2.80
<b>Coal</b>	\$3,000	\$40.00	\$2.00
<b>Nuclear</b>	\$9,375	\$125.00	\$0.80

Source: Lazard. (2018). *Lazard's Levelized Cost of Energy Analysis — Version 12.0*

84 "Citing both past operating experience and future resource planning, the Division [the PSC intervention staff] notes that resources with higher energy availability are chosen over those with lower energy availability. Since energy plays a role in the selection of least-cost resources, the Division concludes that some weight needs to be given to energy in planning for new capacity, and the current weight of 25 percent is reasonable. We find the qualitative argument offered by the Division to be ... convincing." (Utah Public Service Commission, 1999, p. 82). See also Washington Utilities and Transportation Commission (1993, pp. 8-9).

85 The term "straight fixed/variable" is imported from FERC's rate design method for wholesale gas supply, where utilities, marketers and very large customers contract for capacity in a portfolio of individual pipeline and storage facilities. As is true for many electric wholesale purchased

from competitive wholesale markets. This is followed by four different classification approaches and two joint classification and allocation approaches, then a discussion of other technologies and issues.

### 9.1.1 Insights and Approaches From Competitive Wholesale Markets

The ISOs/RTOs that operate energy (and in some cases, capacity) markets — specifically ISO-NE, NYISO, PJM, ERCOT, MISO and the SPP — provide examples of how the recovery of capital investment and nondispatch O&M costs naturally splits between energy and demand. The pricing in these markets can provide both a **competitive proxy** for classifying generation costs and a benchmark to check the reasonableness of other techniques.

ERCOT has no capacity market, and all costs are recovered through time-varying energy charges. Those energy charges are heavily weighted toward a small number of hours, which do not tend to have particularly high loads; the highest-load hours are not the highest-cost hours. Figure 30 on the next page shows the hourly load and Houston Hub prices for 2017 (Electric Reliability Council of Texas, 2018, for load data; ENGIE Resources, n.d., for pricing data).

Prices generally trend upward with load, but the highest-priced hours are spread nearly evenly across load levels.

In 2017, the highest-priced 1% of hours (with prices over \$160 per MWh) would have provided 18% of the annual net margin for a baseload plant with no variable cost, 53% of the margin for a plant with a variable cost of \$20 per MWh (perhaps a combined cycle unit), and 77% of the margin for a plant with a \$30-per-MWh variable cost (such as a recently built combustion turbine), assuming ideal dispatch and no

power contracts, these gas contracts require that the buyers pay for investment-related costs regardless of how they use the resources and pay for variable costs in proportion to their usage. This approach is workable at the wholesale level but is not applicable to retail cost allocation, where the utility bundles a portfolio of generation assets for all of its customers.

86 The coal cost in the table is Lazard's low end, since the high-end cost "incorporates 90% carbon capture and compression" (Lazard, 2018, p. 2), which is in use on only one existing utility coal unit, SaskPower's Boundary Dam. The \$3,000/kW value is also consistent with the costs of the last three coal plants completed by U.S. regulated utilities (Turk, Virginia City and Rogers/Cliffside 6, all completed in 2012). Actual current costs of various vintages of resources will vary for each utility.

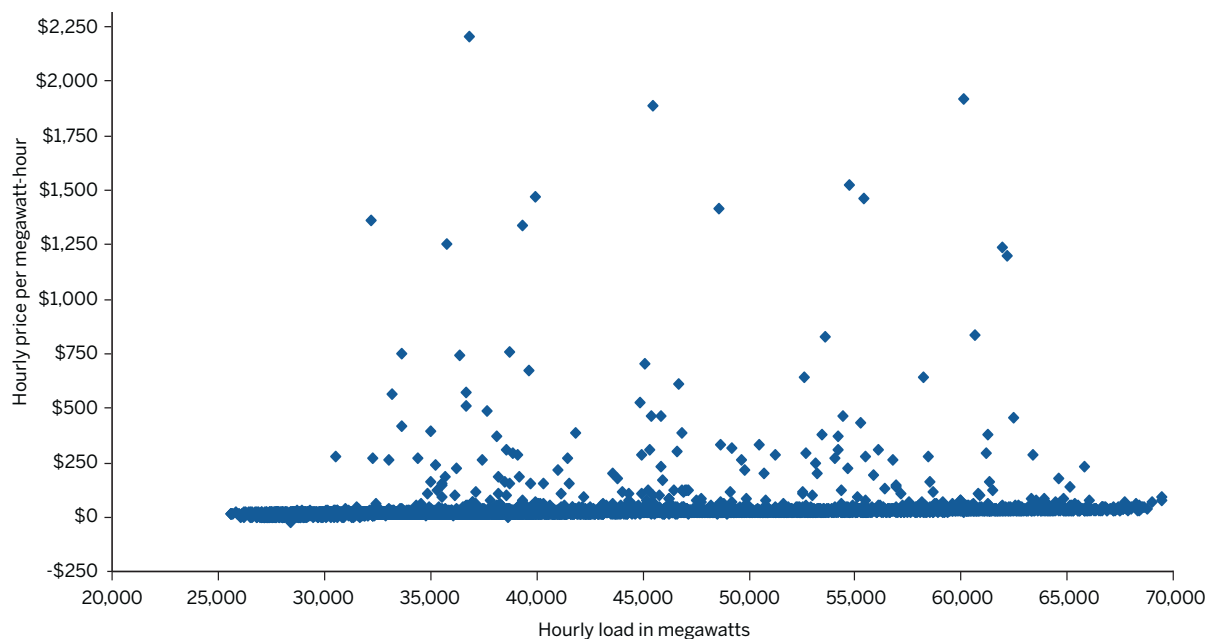
**Figure 30. ERCOT load and real-time prices in 2017**

Sources: Electric Reliability Council of Texas. (2018). *2017 ERCOT Hourly Load Data*; ENGIE Resources. *Historical Data Reports*

outages. Those 88 hours representing the costliest 1% occurred in every month and almost the whole range of annual loads.

In contrast, the 1% of highest-load hours would have provided 5.1% of the margin for the baseload plant, 2.4% for the intermediate plant and 2% for the combustion turbine. This cost pattern suggests that, at least in some systems, generation costs should be time-differentiated but that load is not a good proxy for the highest-price periods. Classes with the ability to shape load to low-cost periods (with demand response or storage) may be much less expensive to serve than those with inflexible load patterns.

Regardless of how the top hours are chosen, the ERCOT data indicate that most of the long-term power supply costs are not recovered from the few peak hours and thus should not be considered demand-related. For a load shaped like the ERCOT average load, only about 3% of the generation costs were associated with the 1% of highest-load hours, and about 20% were associated with the 1% of highest-price hours.

In New England, the ISO-NE external market monitor

estimated that the net revenues available to pay the capital investment and nondispatch O&M costs of a typical recently built gas combined cycle unit would have been about 25% to 60% from the energy market and the remainder from the capacity market, depending on the year (Patton, LeeVanSchaick and Chen, 2017, p. 13). The comparable values for nuclear units were almost all from the energy market (Patton et al., 2017, p. 17).

The PJM independent market monitor reports the capacity revenues and the net energy revenues (i.e., energy revenue in excess of fuel and variable O&M) for a variety of plant types (Monitoring Analytics, 2014, pp. 219-222, 2019, pp. 335-339). These are the revenues available to pay for the capital investment and nondispatch O&M costs and thus represent the market allocation of these costs for the plants. Figure 31 on the next page shows the portion of these costs recovered through capacity payments for four types of new plants (gas-fired combustion turbine and combined cycle units, and hypothetical new coal and nuclear) in each year

**Figure 31. Capacity revenue percentage in relation to capacity factor in PJM**

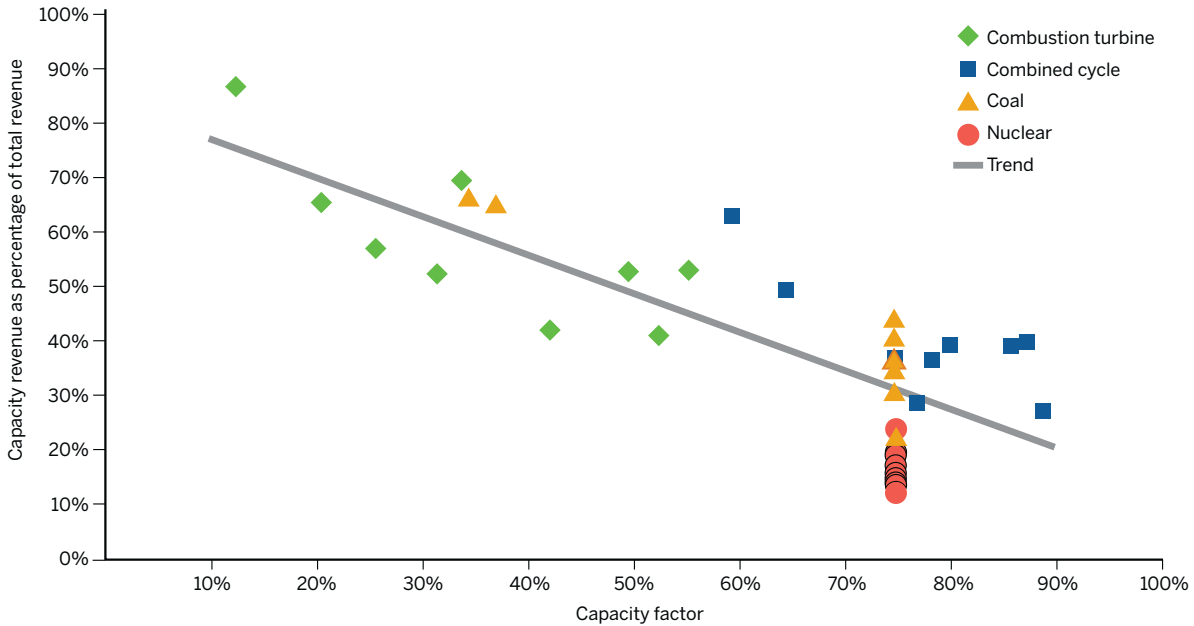

Data sources: Monitoring Analytics. (2014 and 2019). 2013 State of the Market Report for PJM, 2018 State of the Market Report for PJM

2009 through 2017 (Monitoring Analytics, 2014, 2019).<sup>87</sup>

The concept displayed here is that units with a high **capacity factor** tend to make more of their revenue from energy markets instead of from the capacity market. In this set of PJM data, energy revenues cover 14% to 60% of the combustion turbine costs, 38% to 74% of combined cycle costs, 56% to 73% of baseload coal plant costs, about 34% of the costs of economically dispatched coal units, and 77% to 89% of nuclear costs over the nine-year period. The values for 2017 were 39% for modern combustion turbines, 87% for combined cycle units, 65% for coal and 20% for nuclear. Current values for PJM or the relevant load zones could be used as the demand classification percentages for vertically integrated utilities in PJM (e.g., IOUs in Kentucky, Virginia and West Virginia, and municipal and cooperative utilities in several states).

The market monitoring unit of the NYISO provided similar analyses for the various pricing zones of that RTO, as shown in Table 13 (Patton, LeeVanSchaick, Chen and Palavadi Naga, 2018, Table A-14, with additional calculations by the authors). The upstate zones have relatively low capacity

prices, while the Hudson Valley and New York City have very high capacity prices, and Long Island has intermediate prices. Both capacity and energy revenues vary among zones within each of these three areas, between load pockets within zones and among combustion turbine types.

**Table 13. Energy portion of 2017 net revenue for New York ISO**

Zone	Generator type		
	Combustion turbines	Combined cycle	Steam
<b>Upstate</b>	72% to 80%	71% to 79%	42% to 55%
<b>Long Island</b>	52% to 70%	62% to 76%	21% to 57%
<b>Hudson Valley and New York City</b>	31% to 49%	34% to 55%	6% to 29%

Sources: Patton, D., LeeVanSchaick, P., Chen, J., and Palavadi Naga, R. (2018). 2017 State of the Market Report for the New York ISO Markets; additional calculations by the authors

<sup>87</sup> The independent market monitor assumed that a nuclear plant would operate at a 75% capacity factor and made the same assumption for the coal plant through 2015; the capacity factors for the gas-fired plants and for coal in 2016 and 2017 are determined from the economic operation of the units.

## 9.1.2 Classification Approaches

Many utilities and regulators acknowledge that a large portion of generation investment and nondispatch O&M costs is incurred to serve energy requirements. There are two categories of methods to classifying these costs as energy-related and demand-related. First, average-and-peak is a top-down approach that uses high-level data on system loads and costs. Second, there is a range of bottom-up approaches that examine the drivers for costs on a plant-specific basis:

- Base-peak and related methods.
- Equivalent peaker method.
- **Operational characteristics methods.**

As a general matter, the bottom-up approaches are preferable for classifying generation costs. The average-and-peak approach is well suited for shared distribution system costs, as discussed in Section 11.2.

### Average-and-Peak Method

The average-and-peak approach can be applied in classification, when classifying a portion of costs as energy-related and the remainder as demand-related, or in developing a generation capacity allocator that reflects both energy and demand. When using this approach as a classification method, the **system load factor** percentage is classified as energy-related and the remainder as demand-related.<sup>88</sup> When used as an allocation factor, the average-and-peak factor for each class is:<sup>89</sup>

$$\frac{A_c}{A_s} \times \text{SLF} + \frac{P_c}{P_s} \times [1 - \text{SLF}]$$

Where A = annual average load = energy ÷ 8,760

P = peak load

C = class

S = system

SLF = system load factor = (annual energy) ÷ (peak load × 8,760)

The system load factor, and hence the average-and-peak approach more generally, varies over time independent of the mix of the utility's generation resources and does not respond to changes in that mix unless those changes are accompanied by retail pricing that follows the cost structure.

In addition to changing as loads change, the average-and-peak approach ignores the mix of resources and costs. This approach would produce the same classification of plant for a system that was entirely composed of gas-fired combustion turbines (with low capital costs and high fuel costs) or of coal-fired plants (with high capital costs to produce lower fuel costs).

Thus, while the average-and-peak method for generation costs may sometimes fall in the range of reasonable results, it is neither logical nor consistent.

### Base-Peak Methods

Various utilities and other analysts have proposed to subfunctionalize generation resources (in the simplest case, between baseload and peaking plants) and classify each category of generation in a different manner. For example, peakers may be classified 100% as demand-related, while baseload resources are classified 75% to demand and 25% to energy, or some other location- and situation-specific ratio.

More advanced analyses have subfunctionalized generation among base, intermediate and peak categories, known as BIP classification. The base generation might be defined as all nuclear and coal plants, with the intermediate being gas-fired steam and combined cycle plants and the peak units being combustion turbines, storage and demand response. Alternatively, base plants might be any unit that operated at more than a certain capacity factor (for example, 60%), peakers those that ran at less than 5%, and intermediate anything between those 5% and 60% capacity factors. Or, rather than using capacity factor (which can be low due to forced outages, maintenance or economic dispatch), the

<sup>88</sup> This method is sometimes called the system load factor approach. It has also been called "average and excess" because a fraction of cost equal to the system load factor is allocated on energy and the excess of costs on a measure of peak loads (Coyle, 1982, pp. 51-52).

<sup>89</sup> This average-and-peak allocator should not be confused with the average-and-excess demand allocator described in the 1992 NARUC *Electric Utility Cost Allocation Manual*, which allocates a portion of costs in proportion to average load and the excess in proportion to each class's excess of peak load over its average use. That legacy average-and-excess allocator is essentially just a peak allocator (Meyer, 1981).

generation classes can be defined using operating factor (the ratio of output to equivalent availability). At an extreme, each generation type, or even each unit, can be classified separately.

While the base-peak classification approach and related methods are highly flexible, that is both their greatest strength and a great weakness. The strength is that the method can be modified to accommodate the diversity of generation resources; the weakness is that the method requires a set of decisions about the definition of the generation classes and the classification percentage for each class. The base-peak method is connected to actual utility planning only at the highest conceptual level and provides limited guidance for the nitty-gritty details of traditional classification.

One of the challenges of the base-peak approach relates to the changing usage of generation resources. For example, several units that were built to burn coal in baseload operation have been converted to burn natural gas and thus run mostly on high-load summer days.<sup>90</sup> These units operate as peak or intermediate resources (depending on the definitions used in the particular analysis), but most of the capital costs are attributable to the original baseload design. This problem may be ameliorated by removing those additional costs from the base-peak or BIP computation and directly classifying them as energy-related.

Recent technological changes pose additional challenges and opportunities for expanding the base-peak approach from two generation profiles, or the three profiles of the BIP method, to a full analysis of the use of generation resources. Decades ago, it was reasonably accurate to treat generation resources as being stacked neatly under the load duration curve in order of variable costs. The growing role of variable

output renewable resources, additional storage and economic demand response reduces the accuracy of those simple models. Resources like wind and solar do not fit neatly into the BIP categories, providing service in distinct time patterns that may not be related to system loads. At the same time, many utilities have access to much more granular detail on hourly consumption by customer.<sup>91</sup> The BIP method can be expanded to reflect conditions (output by several classes of conventional generation, solar, wind and storage; energy use for storage; usage by class) in as many time periods (or load levels, or bins combining consumption and generation conditions) as desired, even down to an hourly allocation method. Usage and hence costs could thus be assigned directly to the classes using power at the times that each resource provides service.<sup>92</sup>

### Equivalent Peaker Method

The equivalent peaker method,<sup>93</sup> discussed at length in the 1992 NARUC *Electric Utility Cost Allocation Manual*, attributes as demand-related the portion of investment in each resource that would have been incurred to secure a peaking resource, such as demand response or a combustion turbine.<sup>94</sup> Peaking resources are usually treated as 100% demand-related, while intermediate and baseload plants are classified as partly energy and partly demand.

If only peak load had been higher (and other needs were already satisfied) in the years in which the utility made the bulk of its generation construction decisions, it would have likely met that increased load by adding peaker capacity.<sup>95</sup> Utilities historically have justified building baseload capacity by relying on these plants' long hours of use and lower fuel

90 Some coal plants that once ran as baseload resources have been taken out of service in low-load months to reduce O&M costs. This includes Nova Scotia Power's Lingan 1 and 2 (Barrett, 2012), Luminant's Monticello and Martin Lake (Henry, 2012) and the Texas Municipal Power Agency's Gibbons Creek (Institute for Energy Economics and Financial Analysis, 2019).

91 Most utilities have long known the hourly generation by unit.

92 Some utilities refer to their classification method as BIP, even though it does not reflect the differences in costs among the various types of generation. For example, the Louisville Gas & Electric and Kentucky Utilities 2018 "BIP" computation classified nondispatch generation costs this

way: 34% (the ratio of minimum to peak load) to energy; 36% (the 90% ratio of winter peak to summer peak, minus the 34% energy allocation, or 56%, times the 65% of the peak-period hours that occur in winter) to the winter peak demand; and the remaining 30% to the summer peak demand (Seelye, 2016, Exhibit WSS-11). This approach has no cost basis.

93 In some jurisdictions, this is called the peak credit method.

94 This approach is sketched out in Johnson (1980, pp. 33-35) and described in more detail in Chernick and Meyer (1982, pp. 47-65).

95 To some extent, the peakier load would likely allow for development of more demand response and load management. Estimating the potential and costs for these resources under hypothetical load shapes may be difficult.

costs.<sup>96</sup> This incremental capital cost (often called capitalized energy or “steel for fuel”) is attributable to energy requirements, not demand. The investment-related costs of baseload resources above and beyond the cost of peaking units are incurred to serve energy load, not demand. Treating these costs as demand-related overstates the cost of meeting demand and understates the costs incurred to meet energy requirements. This phenomenon has been understood since the 1970s and 1980s:

[T]he extra costs of a coal plant beyond the cost necessary to build a combustion turbine should all be allocated [on] energy. The rationale for this allocation is that the marginal cost of capacity in the long run is just the lowest-cost technology required to meet peak load, which is typically a combustion turbine. Choosing to invest beyond this level [of combustion turbine capital cost] is justified not on capacity grounds, but on energy grounds. That is, the extra capital cost of a coal plant allows the utility to use a low-cost fuel and avoid higher-cost fuels (Kahn, 1988).

However, there are several additional issues with this concept in the modern electric system. First, the method does not adapt well to wind and solar, where the capital investment is primarily justified by avoiding fuel costs but the installed capital cost per nameplate MW may be little different from the cost of a peaker. An intermediate or baseload plant that is not much more expensive than a contemporaneous peaking resource would be classified as mostly demand-related, while very expensive plants are classified as mostly energy-related. And often, peaker units are used to provide energy when baseload units are not operating or to provide power for off-system sales.<sup>97</sup>

Under the equivalent peaker method, the demand-

reliability-related portion of the cost of each generation unit is estimated as the cost per kW of a peaker (usually a simple-cycle combustion turbine) installed in the same period, times the effective capacity of that unit, adjusted for the equivalent availability of a peaker.<sup>98</sup> The cost of the unit in excess of the equivalent gas turbine capacity is energy-related.

However, the simple version of this calculation typically will overstate the reliability-related portion of plant cost because it assumes a steam plant supports as much firm demand as would the same capacity of (smaller) combustion turbines. Due to higher forced outage rates, lengthy maintenance shutdowns and the size of units, a kilowatt of steam plant capacity typically supports less firm load than a kilowatt of capacity from a small peaker. A system with a peak load of about 6,500 MWs and a 65% load factor could achieve the same level of reliability with 80 units of 100 MWs (8,000 MWs, or a 23% reserve) or 19 units of 600 MWs (11,400 MWs, or a 75% reserve), assuming the units all have a 6% **equivalent forced outage rate** and that the load shape can accommodate all required maintenance off-peak. Increasing the equivalent forced outage rate to 10% would increase the required reserve for the 100-MW units to about 40% and for the 600-MW units to 90%. Even with the 6% equivalent forced outage rate, if the load factor were 96%, the reserve requirement would rise to 30% with 100-MW units and 90% with 600-MW units.

Figure 32 on the next page shows the gross plant per kW for combustion turbines as of 2011, from FERC Form 1 data (Federal Energy Regulatory Commission, n.d.). These values include the original cost of the units, plus capital additions since the plants entered service, minus the cost of any equipment retired. This tabulation includes all non-CHP simple-cycle combustion turbines for which cost data were available.<sup>99</sup> Some of the later combustion turbines in this sample may not be pure peakers, since manufacturers

96 Similar reasoning applies to the decision to add renewable resources, substituting investment for fuel costs. See footnote 120.

97 During the 2000-2001 California energy crisis, oil-fired peakers in the Pacific Northwest operated at high monthly capacity factors because they were exempt from both gas supply constraints and California emissions regulations. U.S. Energy Information Administration Form 906 for 2000 and 2001 demonstrates the incremental oil burn in 2000 and 2001, particularly for Puget Sound Energy.

98 In the future, the reference peaking capacity might be an increase in

demand response cost or storage peak output capacity, without an increase in energy generating capability. The reference peaker should always be the least-cost option for providing reliability.

99 Municipal and cooperative utilities and non-utility generators (both those under contract with utilities and those operating in the merchant markets) do not file FERC Form 1 reports, so their units are not included in this analysis. The municipal and cooperative utilities typically retain financial and operating records that are compatible with the FERC system of accounts, allowing comparison of the data for a specific utility's nonpeaking resources with national data on contemporaneous peaker costs.

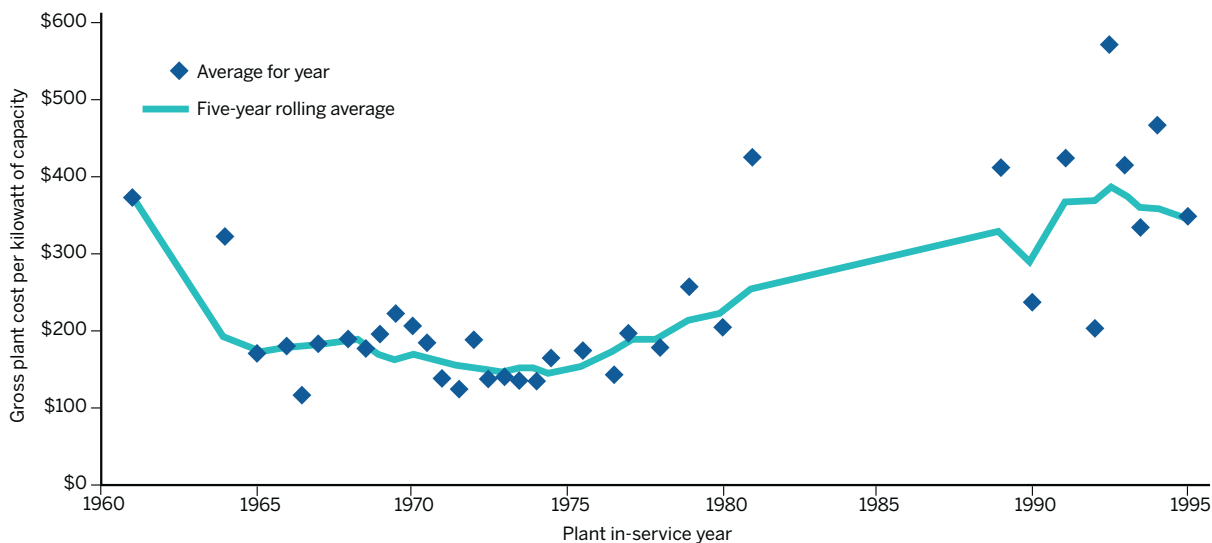

**Figure 32. Cost of combustion turbine plant in service in 2011**

Data source: Federal Energy Regulatory Commission Form 1 database

developed more expensive and more efficient designs, including steam injection.

For comparison, coal plants built in this period generally cost from several hundred dollars per kW to more than \$2,000 per kW; the latest vintage coal plants cost as much as \$3,000 per kW. Steam plants fired by gas and oil (and not converted from coal) tend to have a wide range of gross plant costs, from the prices of contemporaneous combustion turbines to perhaps twice those costs. Nuclear plants generally have gross plant costs well above \$1,000 per kW, up to \$8,000 per kW. Combined cycle plants have usually been 20% to 50% more expensive than contemporaneous combustion turbines.<sup>100</sup>

The capital costs of various types of generating capacity can be compared with the costs of peakers in several ways, including the following:

- Comparing recent or current gross plant costs for other generators with the corresponding cost of peakers, as discussed above.
- Comparing recent or current net plant (gross plant minus accumulated depreciation) costs for nonpeaking generators with the corresponding net plant costs of contemporaneous peakers. This comparison is theoretically the most appropriate basis for classifying generation rate base, which is based on net plant. Unfortunately, net plant is not generally publicly reported by plant or unit, so most cost analysts will have a difficult time implementing this approach. In addition, many utilities have depreciated peakers at a faster rate than steam plants, resulting in lower net plant for a peaker than for a steam plant with the same initial cost, additions and retirements. This results in a higher percentage of the steam plant costs being classified as energy-related based on net plant than gross plant. It is not obvious whether the additional classification to energy is more equitable than the result of the gross plant allocation.
- Comparing the cost of building the actual mix of generation today with the cost of building a peaking-only system today.<sup>101</sup> This approach avoids the problem of

<sup>100</sup> These cost ratios are provided to explain the importance of identifying the demand-related portion of generation investment. Any application of the equivalent peaker method should compare the costs of the utility's existing plants to the costs of contemporaneous peakers, using the most

comparable estimates of the costs of peakers, reflecting geographical and other differences.

<sup>101</sup> The peaking-only system might include combustion turbines, demand response and storage resources.

estimating the cost of building peakers at various times in the past. But many existing plants could not be built today as they currently exist — a new coal plant may require scrubbers, nitrogen oxide reduction, closed-system cooling and other features that the existing coal plant does not have.<sup>102</sup> Other plant types, such as oil- and gas-fired boiler units, no longer make economic sense and would not be built today. Determining the cost of building a new 1970s-style coal plant or a gas-fired steam plant may be much more difficult than determining the cost of peakers in the 1970s. And for some technologies, the costs of new construction do not meaningfully reflect the costs of the plants currently embedded in rates. For example, as expensive as the nuclear units of the 1980s were, the nuclear units currently under construction are much more expensive. Conversely, the costs of wind turbines have fallen dramatically since the 1980s. Comparing today's costs for those resources to the costs of new peakers would probably overstate the energy-related portion of the costs of an old nuclear unit and understate the energy-related portion of the costs of an old wind farm.

Whether the comparison uses gross plant in service, net plant in service or hypothetical new construction, the data sources should be as consistent as possible. It would not be appropriate to compare the current book value of an actual plant with the cost of a hypothetical plant in today's dollars (Nova Scotia Utility and Review Board, 1995, p. 18).

Table 14 shows the equivalent peaker method analysis that Northern States Power Co.-Minnesota (a subsidiary of Xcel Energy) used in its 2013 rate case filing (Peppin, 2013, Schedule 2, p. 4).<sup>103</sup> The capacity portion for each plant type is the ratio of the peaking cost (\$770 per kW) to the plant type cost. For example, the peaking cost is 20.9% of the cost of the nuclear plant, so 20.9% of the nuclear investment is treated as capacity-related. The company uses its estimates of the replacement costs of each type of generation and applies the results to each capital cost component (gross plant, accumulated depreciation, deferred taxes, etc.).

**Table 14. Equivalent peaker method analysis using replacement cost estimates**

Resource type	Cost per kW	Capacity-related share of cost	Energy-related share of cost
<b>Peaking</b>	\$770	100%	0%
<b>Nuclear</b>	\$3,689	20.9%	79.1%
<b>Fossil*</b>	\$1,976	39.0%	61.0%
<b>Combined cycle</b>	\$1,020	75.4%	24.6%
<b>Hydro</b>	\$4,519	17.0%	83.0%

\*The "fossil" resource type appears to be coal- or gas-fired steam.

Source: Peppin, M. (2013, November 4). Direct testimony on behalf of Northern States Power Co.-Minnesota. Minnesota Public Utilities Commission Docket No. E002/GR-13-868

This is not a very realistic comparison, for reasons discussed above. Many of the plants could not be built today, and some have complicated histories of retrofits and repowering. The nuclear replacement cost appears to be particularly optimistic compared with the cost of nuclear power plants under construction today.

Table 15 on the next page shows an alternative analysis based on the Xcel Energy Minnesota subsidiary's actual investments in each plant type at the end of 2017, from Page 402 of its FERC Form 1 report (Federal Energy Regulatory Commission, n.d.).

The results of the two analyses are generally consistent, except for the classification of the combined cycle resources. These plants are of more recent vintage than the others; a fairer comparison, using peaker costs contemporaneous with the in-service dates of each of the other resources, probably would result in a lower energy classification of the combined cycle resources and higher energy classification for the coal and nuclear units.

The equivalent peaker method does have limitations. Perhaps most importantly, it requires cost comparisons of individual generation units with peakers of the same vintage. Utilities installed combustion turbines as far back as the early 1950s, but the technology was widely installed only in the late 1960s. The oldest remaining combustion turbine owned

<sup>102</sup> Many hydroelectric projects could not be licensed if they were proposed today.

<sup>103</sup> The company calls this a plant stratification analysis.

**Table 15. Equivalent peaker method analysis using 2017 gross plant in service**

Resource type	Capacity (MWs)	Plant in service		Excess over combustion turbine		Energy-related share of cost
		Cost	Cost per kW	Cost	Cost per kW	
<b>Combustion turbine</b>	1,114	\$291,000,000	\$261	N/A	N/A	0%
<b>Nuclear</b>	1,657	\$3,448,000,000	\$2,081	\$3,016,000,000	\$1,820	87%
<b>Coal</b>	2,390	\$2,156,000,000	\$902	\$1,532,000,000	\$641	71%
<b>Combined cycle</b>	1,266	\$939,000,000	\$742	\$609,000,000	\$481	65%
<b>All resources</b>	6,427	\$6,834,000,000	\$1,063	\$5,157,000,000	\$802	75%

Data source: Federal Energy Regulatory Commission Form 1 database records for Northern States Power Co.-Minnesota

by a utility filing cost data (Madison Gas and Electric's Nine Springs) entered service in 1964. The paucity of earlier data complicates the use of the equivalent peaker method for classifying the costs of older plants. This problem is gradually fading away, as all pre-1970 nuclear is gone and much of the pre-1970 fossil-fueled steam capacity has been retired or is nearing retirement, but the issue remains for classifying hydro plant costs and the few remaining old fossil fuel plants (U.S. Energy Information Administration, 1992).

One solution to the problem of classifying the investment in very old, little-used steam plants is to treat that cost as entirely demand-related. Since these units often represent a very small portion of generation rate base, this solution may be reasonable.

A full equivalent peaker analysis would compare the product of the actual depreciation charges for the nonpeaking plants with the product of the peaker depreciation rate and the peaker-equivalent gross investment for the same reliability contribution. Since the classification of rate base

usually ignores the higher accumulated depreciation of peakers compared with the accumulated depreciation for other generation resources of the same vintage (which tends to overstate the demand-related portion of generation rate base), it is also generally symmetrical to classify generation depreciation expense as proportional to the demand-related portion of gross plant (which will tend to understate the demand-related portion). If classification of one of these cost components is refined to reflect the difference in depreciation rates, the other cost component should be similarly adjusted.

As is true for plant in service, the nonfuel O&M costs of steam plants are generally much higher than the nonfuel O&M costs of combustion turbines. Typical O&M costs per kW-year are \$1 to \$10 for combustion turbines, \$10 to \$15 for combined cycle plants, \$10 to \$20 for oil- and gas-fired steam plants, \$40 to \$80 for coal plants and more than \$100 for nuclear plants. Table 16 shows how the capacity-related O&M for conventional generation might be classified between energy and demand, using the utility's actual nonfuel O&M

**Table 16. Equivalent peaker method classification of nonfuel operations and maintenance costs**

Resource type	Capacity (MWs)	Nonfuel operations and maintenance		Excess over combustion turbine		Energy-related share of cost
		Cost	Cost per kW-year	Cost	Cost per kW-year	
<b>Combustion turbine</b>	1,114	\$4,170,000	\$3.74	N/A	N/A	0%
<b>Nuclear</b>	1,657	\$215,880,000	\$130.28	\$209,680,000	\$126.54	97%
<b>Coal</b>	2,390	\$33,490,000	\$14.01	\$24,550,000	\$10.27	73%
<b>Combined cycle</b>	1,266	\$16,380,000	\$12.94	\$11,650,000	\$9.20	71%

Data source: Federal Energy Regulatory Commission Form 1 database records for Northern States Power Co.-Minnesota

costs; the data are 2017 numbers from FERC Form 1, Page 402, for Northern States Power Co.-Minnesota (Federal Energy Regulatory Commission, n.d.).

Table 16 does not include the company's wind resources, which average about \$30 per kW-year in O&M, since MISO credits wind with unforced capacity value at only about 15% of rated capacity, or about 17% of the value of an installed MW of typical conventional generation. The demand-related portion of the wind capacity is thus less than \$1 per kW-year, and the wind O&M is almost all energy-related.<sup>104</sup>

### Operational Characteristics Methods

The operational characteristics methods classify generation resources (units, resource types, purchases) based on their capacity factors or operating factors. Newfoundland Hydro classifies as energy-related a portion of the cost of each oil-fueled steam plant equal to the plant's capacity factor (Parmesano, Rankin, Nieto and Irastorza, 2004, p. 22). At first blush, this approach appears to roughly follow the use of the resource, with plants that are used rarely being treated as primarily demand-related and those used in most hours classified as predominantly energy-related. Unfortunately, the use of capacity factor effectively classifies more of the cost to demand as the reliability of the resource declines.

A better approach would be to use the resource's operating factor, which is the ratio of its output to its equivalent availability (that is, its potential output, if it were used whenever available). This approach would classify any resource that is dispatched whenever it is available (e.g., nuclear, wind and solar) as essentially 100% energy-related. That may be seen as an overstatement, since those resources generally provide some demand-related benefits and are sometimes built to increase generation reliability, as well as to produce energy with little or no fuel cost.

### 9.1.3 Joint Classification and Allocation Methods

Although most cost of service studies classify capital investments and capacity-related O&M as either demand-related or energy-related, classify power and short-term variable costs as energy-related, and then allocate energy-related and demand-related costs in separate steps, two approaches accomplish both at once. These are the probability-of-dispatch (POD) and **decomposition** approaches.

#### Probability of Dispatch

The POD approach is the better of the two.<sup>105</sup> Methods using this approach are generically referred to as probability of dispatch, even for versions that do not explicitly incorporate probability computations.<sup>106</sup> A simplified illustrative example of power plant dispatch is shown in Figure 33 on the next page, under the utility load duration curve. The example uses only four types of generation: nuclear, coal, gas combined cycle and a peaking resource consisting of a mix of demand response, storage and combustion turbines. An actual POD analysis might break the generation data down to the plant or even unit level and may need to include load management and demand response as resources. This simplified example also does not illustrate maintenance, forced outages or ramping constraints.

Off-system sales and purchases can be added or subtracted from the load duration curve when they occur, or they can be subtracted or added to the generation available in each hour or period. Similar adjustments may be needed to reflect the charging of storage and operation of behind-the-meter generation.

Figure 34 shows the composition of demand in each hour for the same illustrative system, divided among three customer classes. In this example, the residential class peak load occurs when load is high but not near the system peak.

104 The nonfuel O&M costs per kW for Northern States Power's two small waste-burning plants and its small run-of-river hydro plant are even higher than the nuclear O&M and hence are effectively entirely energy-related, even if the hydro plant provides firm capacity.

105 The Massachusetts Department of Public Utilities explained its preference for this method as follows: "The modified peaker POD results

in a fair allocation of embedded capacity costs because this method recognizes the factors that cause the utility to incur power plant capital costs and because this method allocates to the beneficiaries of fuel savings the capitalized energy costs that produce those savings" (1989, p. 113).

106 For an example of the POD method, see La Capra (1992).

**Figure 33. Simplified generation dispatch duration illustrative example**

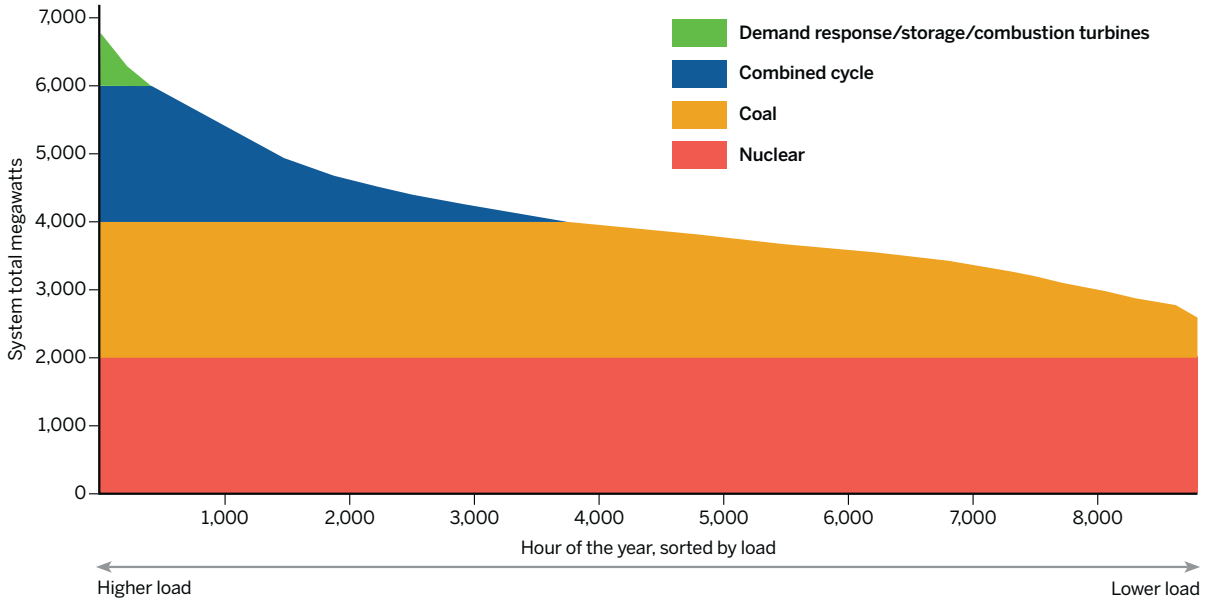

This situation might arise for a winter-peaking residential class in a summer-peaking system, or an evening-peaking residential class in a midday-peaking system.

Note that the three customer classes need not peak at the same time. On a high-load summer day, the primary

industrial class might peak in the morning, the secondary commercial class at 1 p.m., and the residential class in the evening. Large commercial buildings typically experience their peak load in the summer, since large buildings require cooling in most climates. If a large percentage of home

**Figure 34. Illustrative customer class load in each hour**

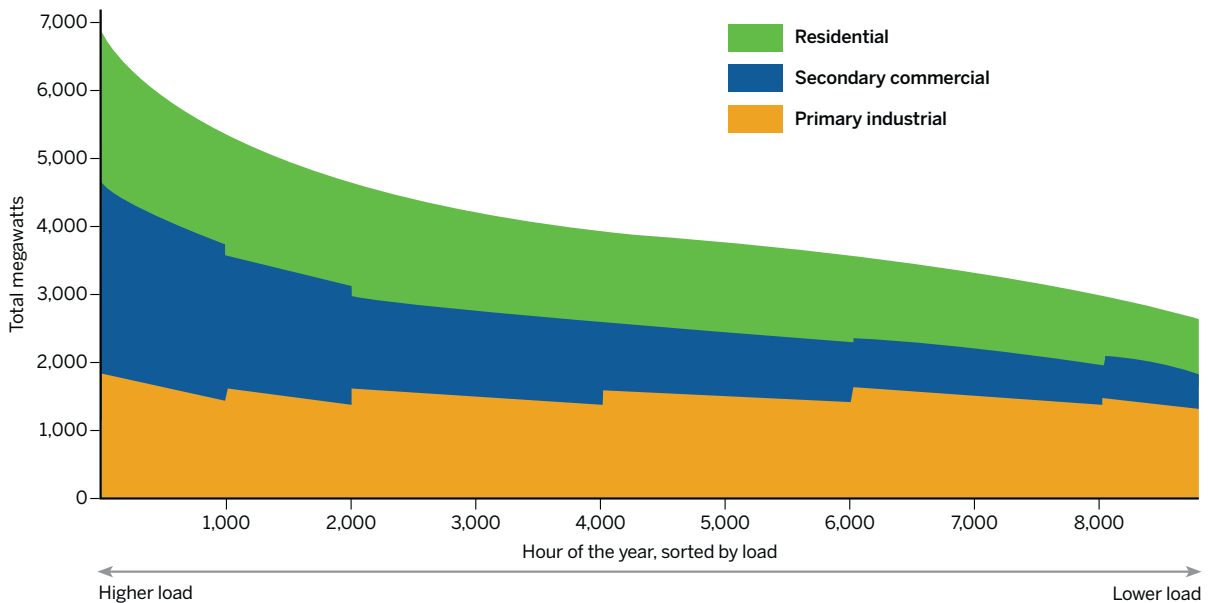

**Table 17. Class share of each generation type under probability-of-dispatch allocation**

Customer class	Generation source			
	Nuclear	Coal	Combined cycle	Peaking resources
<b>Residential</b>	34%	34%	32%	31%
<b>Secondary commercial</b>	28%	29%	39%	42%
<b>Primary industrial</b>	38%	37%	29%	27%

heating is electric, the residential class is likely to experience its highest load in the winter, even in places like Florida. The industrial class loads may peak in a variety of seasons, driven by vacation and maintenance schedules, variation in inputs (e.g., agricultural products) and demand, and other factors. The system peak may occur at a time different from all of the customer class NCP demands.

Table 17 shows how the costs of each generation resource would be allocated to the classes in the illustrative example in Figure 34. In the lowest-load hours, when nuclear is serving 80% of the energy load, the industrial class uses half the system energy and hence half the nuclear output; in the highest-load hours, when nuclear is serving about 29% of the load, the industrial class uses about 27% of the system energy. Averaged over the year, the industrial class uses 38% of the nuclear output. In the hours that the combustion turbines are running, the industrial class uses only 27% of the peaking resources' output, since the residential and commercial classes dominate loads in that period.

The commercial class is responsible for the largest share of the summer peak and hence of the combustion turbine costs but the smallest part of the low-load hours and hence the lowest share of the nuclear and coal costs. Every class pays for a share of each type of generation.<sup>107</sup>

The POD method has been applied with a wide range of detail. The generation "dispatch" over the year may represent historical or forecast operation, equivalent availability or capacity factor, seasonal variation (due to maintenance

outages, hydro output, natural gas price, off-system purchases and sales), actual hourly output (reflecting planned and random outages and unit ramping constraints) and other variants. The POD method is thus one approach to hourly allocation. Ideally, dispatch and class loads should use the available data to match costs with usage as realistically as possible.

The POD approach has some limitations. Most importantly, it does not consider the reason that investments were incurred, only the way they are currently used. The costs of an expensive coal plant no longer needed for baseload service and converted to burn natural gas and operating at a 10% capacity factor to meet peak loads might be allocated in exactly the same way as the costs of a much less expensive combustion turbine operating at 10% capacity factor.<sup>108</sup> The excess costs of the converted coal plant are due to its historical role of providing large amounts of energy at then-attractive fuel costs; those costs were not incurred for the 10% of hours with highest demand. The same considerations arise for other steam plants that operate at much lower capacity factors than they were planned for and justified by. Some hydro plants have also changed operating patterns from their original use, either running for more hours to maintain downstream flow or for fewer hours due to reduced water supply. Peaking capacity is used to provide a range of ancillary services at many load levels, including upward ramping services (when load surges during the day or wind and solar output falls) and operating reserves (especially to back up large generation and transmission facilities). Reflecting these considerations may require modification of the inputs to the POD analysis, which considers only current use, not historical causation.

Second, the POD method spreads the cost of each resource equally to all hours or energy output, assigning the same cost of a totally baseload plant (with a 100% capacity factor) to the lowest-load off-peak hour as to the system peak hour. That approach comports with some concepts of equity and cost responsibility: The cost of each resource is allocated

<sup>107</sup> If this example had included a street lighting class, that class might not have been allocated any combustion turbine costs if the lights would not be on in the summer peak hours. In a more realistic example, including outages of the baseload plants, the combustion turbines probably would operate in some hours with street lighting loads and the lighting class would be allocated some combustion turbine costs.

<sup>108</sup> In the simpler forms of POD, the costs of both plants would be spread over the top 10% of hours. In more sophisticated approaches that map generation to actual operating hours, the steam plant would generate in many hours with load lower than the top 10%, while missing some of the top 10%, due to limits on load following.

proportionately to the classes that use it. On the other hand, it can be argued that the hours with higher marginal energy costs contribute more of the rationale for investing in that resource and that, in a sense, each kWh of usage at high-load times should bear more of the resource's investment-related costs than should each kWh in the off-peak hours. This concern can be addressed by weighting the energy over the hours, such as in proportion to some measure of hourly market price.

Third, it is important that the load and dispatch data be representative of the cost causation or resource usage in the years for which the cost allocation will be in place. For example, a baseload plant may have operated at only 40% capacity factor in the most recent year because of major maintenance or availability of economic energy imports. Or load and dispatch in the last 12 months of data may be atypical because of an extremely cold winter and mild summer. The POD allocation should be based on weather-normalized dispatch and load, just as the rate case costs allowed by the regulator and included in the cost of service study should reflect weather-normalized load.

### Decomposition

Class obligations for generation costs have occasionally been addressed by dividing the generation resource into separate generation systems serving hypothetical loads for portions of the utility's customers, such as just the residential customers, just the commercial customers and just the industrial customers. For example, industrial customers in Nova Scotia have argued that their high-load-factor demands could be served by the capacity and energy of some set of baseload plants, where those costs are lower than the average generation cost per kWh (Drazen and Mikkelsen, 2013, pp. 11-16). The industrial advocates for this approach assume that the flat industrial load would be served exclusively by baseload plants and that all other costs should be allocated to other classes.<sup>109</sup> A similar approach might inappropriately be suggested to justify allocating the highest-cost resources to customers with behind-the-meter solar generation and lower-cost resources to nonsolar customers whose load does not dip in midday. The method might also be used to test

whether classes are paying for enough capacity to cover their energy and reliability requirements.

In the context of resources stacked under a load duration curve, such as that shown in Figure 33 on Page 119, the decomposition approach allocates the resource mix horizontally, rather than the vertical allocation used in the POD method. Figure 35 on the next page illustrates the decomposition approach.

In essence, the decomposition method treats the utility as if it were multiple separate utilities. In the case of Figure 35, the utility system is decomposed into an all-nuclear system with enough capacity to meet the industrial peak load, and a utility with a little nuclear and all the other resources to serve all other load. Whether the industrial customers would support this allocation would usually depend on the cost of the nuclear resources compared with the system average.

The decomposition approach conflicts with reality in many ways, including:

1. The reserve requirements for the decomposed systems would be driven by their noncoincident class peaks or high loads (if they are assumed to be fully free-standing), requiring additional hypothetical capacity for utilities that are not already extensively overbuilt. If the decomposition assumes that the multiple class-specific systems would operate in a power pool, contribution to the system peaks would drive capacity requirements.
2. A system with a high load factor and relatively few large units would require a very high reserve margin (as discussed in Subsection 5.1.1) to cover fixed outages and even maintenance outages. The reserve units would operate in many hours (since the system load would always be near the allocated baseload capacity).
3. A baseload-only system would require a large amount of backup supply energy, either from hypothetical units or as purchases from the other classes.
4. The decomposition approach is usually designed to assign the lowest-cost resources to the industrial class,

---

<sup>109</sup> A decomposition method that accounts for all relevant factors may not show an advantage for industrial customers. In Alberta, a related method to the decomposition method was presented to demonstrate that baseload power for industrial customers would be considerably more expensive than the demand-based cost allocation of the existing system for the industrial class (Marcus, 1987).

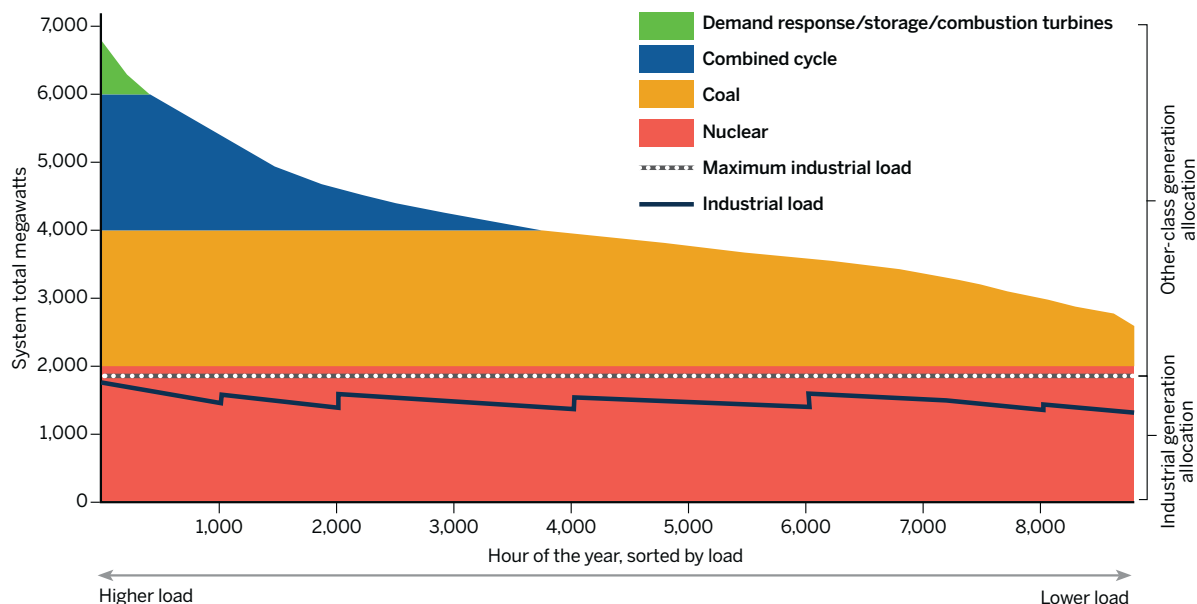
**Figure 35. Illustration of decomposition approach to allocating resource mix**

shifting all the costs of mistakes and market changes onto the other classes. That includes excess capacity (even excess baseload and capacity made excess by decline in industrial loads), the costs of fuel conversion and the high costs of plants built as baseload but currently operated as peakers.

5. It is not clear how variable renewables and other unconventional resources would be incorporated into the decomposed utility systems.

It is possible (if not certain) that the decomposition approach could be expanded and revised to create a viable classification and allocation method, but at this point no such model has been developed.

#### 9.1.4 Other Technologies and Issues

Several types of generation costs do not fit neatly into the classification methods discussed in the previous sections. Some of those costs, such as hydro resources and purchased power, have been part of utility cost structures since before the development of formal cost of service studies. Others, such as excess capacity and uneconomic investments, became prominent in recent decades. More recently, utilities have

needed to deal with allocating nonhydro renewable costs; a few utilities already have significant costs for nonhydro storage (mostly batteries) and most will need to deal with those costs in the future. As technologies change, new cost allocation challenges will arise — for new resources, repurposed existing assets and newly obsolete resources.

#### Fuel Switching and Pollution Control Costs

Many fuel conversion investments have been undertaken to reduce fuel costs or increase the reliability of fuel supply for high-capacity-factor power plants.

This category includes:

- Conversion of oil-fired steam plants to burn coal in the 1970s and 1980s (most of which have since been retired).
- Conversion of gas-fired plants to burn oil in the 1970s, when the supply of gas was limited.
- Conversion of oil-fired plants to co-firing or dual firing with gas since the 1990s to achieve environmental compliance and reduce fuel costs.
- Conversion of coal-fired plants to partial or full operation on gas to achieve environmental compliance.
- Conversion of coal-fired plants to partial or full



operation on biomass to achieve environmental compliance and RPS credit.<sup>110</sup>

- Conversion of coal-fired plants to partial or full operation on petroleum coke, tire-derived fuel or other waste to reduce fuel costs.

These investments and resulting longer-term operating costs may reasonably be classified as 100% energy-related.

Most pollution control retrofit costs are incurred to comply with regulatory requirements to reduce the environmental effects of fossil-fueled plants and to allow them to continue burning low-cost fuel at high capacity factors. Peaking units that are needed only in a few high-load hours annually can afford to burn expensive clean fuels and are often allowed to have higher emissions rates since they operate so little. Hence, the need for the pollution control is driven primarily by the energy-serving function of the nonpeaking fossil plants. These environmental costs are most often related to emissions standards for air pollutants, but some substantial costs are driven by the need to protect water quality and aquatic life and to meet other health and environmental standards. As a result, the identifiable capital investment and nondispatch O&M costs of pollution controls may reasonably be classified as 100% energy-related or allocated in proportion to class usage of energy during the times that the plant is operated, to recognize the causes of the environmental retrofits.<sup>111</sup>

### Excess Capacity and Excess Costs

Utilities sometimes add generation that is not needed to maintain adequate reliability. Some of that excess capacity may result from the lumpiness of generation additions or declining load, with no clear connection to the classification of the additional costs. Other times the excess is the result of the long lead times for certain baseload generation (especially nuclear, but also some coal and hydro facilities), which can result in a plant being completed after the need for its

capacity has vanished and the value of its energy output has decreased dramatically. One or both of those outcomes befell many of the nuclear plants and some coal plants in the late 1970s and 1980s. The long lead times are generally the result of choices to build plants to produce large amounts of energy at low variable costs; in those cases, there is a reasonable presumption that the costs of the excess capacity are due to anticipated or actual energy requirements.<sup>112</sup>

Excess capacity can be priced at the costs of contemporaneous peaking capacity and allocated among classes in proportion to the differences between projected class contribution to peak loads (at the time commitments were undertaken) and actual current class loads. Excess capitalized energy costs (net of equivalent peaking capacity costs and any fuel savings) similarly can be allocated in proportion to the differences between class projected energy requirements and their actual energy requirements.

Table 18 on the next page provides an illustration of the allocation of excess capacity among classes to reflect responsibility for the excess. In this illustration, the actual load in the rate case test year is 600 MWs lower than the load forecast at the time the utility committed to the excess capacity. Because of other adjustments in supply planning, the utility has about 480 MWs of excess capacity, which would support about 400 MWs more load than the actual need. That 400-MW excess is allocated among the classes in proportion to their shortfalls in load.<sup>113</sup>

This adjusted peak load could be used in allocating peaking resources or the peaking-equivalent portion of all generation resource costs. A similar approach could be applied to allocate the additional costs of having a baseload-heavy resources mix resulting from actual energy use being lower than the forecast usage.

Another source of excess capacity is the addition of clean resources to allow the reduced use of dirty older generation, which thus allows the utility to meet environmental

110 In principle, biomass conversion might also reduce fuel costs, although that is not necessarily the case.

111 Nova Scotia Power uses this adjustment to the average-and-peak approach (Nova Scotia Power, 2013a, p. 37).

112 Accounting for a suboptimal system resource mix (and other inefficiencies) is also discussed in detail in Chapter 18.

113 Any load shortfall due to increased utility efficiency efforts since the commitment to build the capacity should generally be excluded from the shortfall.

**Table 18. Allocation of 400 MWs excess capacity to reflect load risk**

	Forecast load (MWs)	Actual load (MWs)	Load differential	Share of load shortfall	Allocated excess (MWs)	Load for allocation (MWs)
<b>Residential</b>	1,400	1,500	+100	0%	0	1,500
<b>Secondary commercial</b>	2,300	2,000	-300	43%	171	2,171
<b>Primary industrial</b>	2,700	2,300	-400	57%	229	2,529
<b>Total</b>	6,400	5,800	+600	100%	400	6,200

requirements, reduce fuel costs or meet portfolio standards.<sup>114</sup> Even though these new clean resources may raise the reliability of generation supply (usually above an existing adequate level), their costs were incurred as a result of energy loads; in these cases, the excess capacity should be recognized as energy-related.<sup>115</sup>

Aside from excess capacity, changing economic, technological and regulatory conditions can result in a facility providing a service different from its original purpose. For example, a previously baseload generation plant may run on only a few days annually or may house a distribution service center. The plant may still have unrecovered capital costs, environmental cleanup obligations or other burdens. If the full cost of the repurposed facility exceeds its value in its new use, the excess costs should be allocated based on its former use as a baseload generating plant.<sup>116</sup>

Finally, the amortization of a canceled generation plant is attributable to the reason the utility spent the money on

the plant, long before the plant's costs and benefits were clear. Many nuclear plants were canceled after the utility spent more on the plant than the entire original expected cost, most recently the Summer plant in South Carolina. A number of coal plants were also canceled after the commitment of substantial funds.

### Hydroelectric Generation

The classification of hydroelectric generation presents some issues that differ from those of thermal generation.<sup>117</sup> First, many large generation facilities installed prior to 1960 are still in operation, so their costs are difficult to classify using the equivalent peaker method. Most of them could not be built today, given environmental siting constraints, so comparing new construction costs with new peaker costs may not be practical. Second, each conventional hydro facility consists of turbines and dams (and other civil works), which have different and varying effects on the energy and

114 MidAmerican Energy, for example, will have added over 6,000 MWs of wind in the period 2004-2020 to reduce fuel costs to its retail customers but has kept most of its fossil generation in operation (Hammer, 2018). This could result in a MISO-recognized reserve margin of 26% in unforced capacity terms in certain areas (Hammer, 2018, Table 3). This is nearly three times the typical MISO-required unforced capacity reserve around 8% (Midcontinent Independent System Operator, 2018, p. 23).

115 Texas and Iowa established their initial renewable portfolio standards in terms of installed capacity, rather than the more common energy percentage requirement, and several jurisdictions have established targets for specific renewables (e.g., solar, offshore wind). See Texas Utilities Code § 39.904 and Iowa Code Ch. 476 §§ 41-44. The motivations for these targets, however they are formulated, have been primarily related to reducing fuel costs and emissions. Both Texas and Iowa have exceeded their requirements and continue to add renewables to reduce fuel and other energy costs.

116 Excess costs can also be associated with underutilized or repurposed facilities. For example, a retired steam power plant may be used to warehouse distribution equipment; the generator may be operated as a synchronous condenser to support the transmission system; or a portion of the plant site may remain in service to house a combustion turbine, a transmission switching station or a control center. Sometimes this is intentionally done to avoid (or evade) a rate base disallowance for a unit retired prior to being fully depreciated. Most of those costs continue to be attributable to the original purpose of the steam plant and hence to energy and demand. Similarly, the utility may face cleanup costs for a former coal gasification site or any site contaminated by hazardous materials (e.g., heavy metals, waste lubricating oil or PCB-contaminated transformer oil). Regardless of how that site is used today or was most recently used, the cleanup costs are attributable to the activity that generated the contamination, not the current use.

117 The treatment of pumped storage, where water is pumped uphill off-peak and released to produce electricity during peak periods, is addressed with other storage technologies in Subsection 9.1.4.

demand values of the facility. Adding a turbine may increase the facility's capacity at peak load times without increasing energy output, since total energy output is limited by the amount of water flowing in the river. At another hydro facility, adding an additional turbine will not increase the output in periods of peak need (usually summer and winter) because there is not enough water to run the additional turbine, but it may increase energy output in the spring flood; this energy has value, even if it does not contribute to meeting peak load. Adding additional water storage (such as in an upstream reservoir to hold water from the spring flood) may allow the plant to operate longer hours each day but may not increase the contribution in peak hours. Increasing the height of a dam may increase capacity by raising the hydraulic head and also increase energy output because of both the greater head and the increased storage volume.

Hydro is distinct in that the fuel supply (water) is limited, and although the units usually can be dispatched to cover higher-cost hours, doing so precludes using the units at lower-cost hours. Utilities have often recognized this dual function of hydro investments by classifying hydro plant costs to both energy and capacity. For example:

- BC Hydro in British Columbia classifies hydro generation as 45% energy-related (BC Hydro, 2014, p. 9).
- Newfoundland and Labrador Hydro has proposed classification of 80% energy for a new hydro project (Newfoundland and Labrador Hydro, 2018, p. 6).
- Manitoba Hydro has long classified its generation as 100% energy-related, but this was modified in 2016 to an average-and-peak classification approach with a broad peak demand allocation measure (Manitoba Public Utility Board, 2016, pp. 47-53).

Other utilities, including Idaho Power, Hydro-Québec, and Newfoundland and Labrador Hydro, use the average-and-peak approach for legacy hydro.

In selecting classification and allocation methods it is important to recognize the usage of each type of hydro resource. Some are run-of-river, with each hour's output determined by the amount of water flowing through the system. Other hydro resources have limited flexibility in dispatch due to environmental constraints. Both of these categories of hydro resources should be treated as variable, similar to wind and solar.

Other categories of hydro resources have some storage capacity, allowing the operator to optimize dispatch over a day, a week or even a year.<sup>118</sup> These resources are generally operated under a reliability-constrained economic dispatch regime, but since the variable cost is zero or minimal, they are dispatched to maximize the value of their limited energy supply rather than in merit dispatch order. For example, a hydro resource may be able to generate 100 MWhs in the hour ending at 2 a.m. at no cost, but the dispatcher is likely to prefer to keep the water in the reservoirs to be used for operating reserves, load following and avoidance of fuel costs in higher-cost hours later in the day.

The difference between the dispatch of hydro and thermal resources requires some adaptation in classification and allocation approaches. In some applications of the BIP classification approach, for example, resources are stacked under the load duration curve starting with the resources with the lowest variable costs. In a system with a significant hydro contribution, the method must be modified to reflect the value (not cost) in time periods (ideally hours) in which hydro energy is actually provided, whether that is due to run-of-river, minimum flow or economic dispatch.

It may be appropriate to recognize that some hydro resources are justified primarily by avoiding fuel costs in high-load hours, resulting in allocation of the investment-related hydro costs in proportion to some measure of hourly market or marginal energy costs.<sup>119</sup>

118 Many of these resources will also operate with little or no flexibility in the spring flood, with minimum flow constraints (which may change by season) and with requirements for flow variation for streambed maintenance, recreational activities, flood control and other factors.

119 Many hydro resources bear the costs of providing services unrelated to electric generation, such as flood control, recreation, water supply

and environmental protection. Other resources, especially those built in recent decades, may also bear the costs of endangered species protection, conservation easements, access to open space, aesthetic screening around a plant or payments in lieu of taxes. If the non-energy benefits are conditions of a license or permit, those are simply the costs of building or running the plant.

## Renewable Energy

Renewable energy, generated from wind, solar, biomass, hydro, geothermal and other technologies, is becoming a larger part of the electric supply mix and hence the cost allocation challenge. Renewable resources may have very different cost characteristics than conventional resources, and the decision to invest in them may be driven by policy that may not consider peak demand at all.

As discussed in Subsection 7.1.2, renewable energy may be added — even though the utility does not need the capacity at peak hours — to reduce fuel costs, comply with portfolio requirements (which often require that a specified percentage of energy consumption is supplied by renewable generation) or meet environmental targets, particularly reducing the atmospheric effects of fossil energy generation. This substitution of capital investment for fuel is widely accepted as an important approach in 21st century utility planning, as shown in examples from Colorado, Iowa and Indiana.<sup>120</sup>

In the classification of costs between capacity and energy, renewable costs that are driven by energy consumption, either directly or indirectly, should be classified as energy-related. For renewable resources that provide some demand-related benefits, the costs can be classified between demand and energy based on the equivalent peaker, average-and-peak or other methods, as long as the demand-related portion is discounted to reflect the effective load-carrying capacity of the renewable resource. Variable renewable resources fit well in a time-based allocation (such as a detailed POD allocation) because their costs can be allocated directly to the hours in which they provide energy to the system.

## Purchased Power

Many power purchase agreements with utilities or non-utility generators (especially fossil-fueled generation) have been structured with two types of charges: predetermined monthly charges the utility must pay regardless of how

much energy it takes from the power producer, as long as the supplier meets contracted requirements for availability; and variable charges per MWh that the buyer pays for the energy it takes. The charges may reflect the projected cost of a single unit or plant (traditionally fossil fueled, increasingly renewable) at the time the contract was signed, or the actual cost of service for a unit or a portfolio of resources.

Another large set of power purchase agreements — including PURPA contracts, some dating back to the 1980s, and most 21st century renewable projects — pay the provider a rate per kWh delivered (perhaps with different rates by time of delivery). This cost structure fits well into an hourly allocation framework, although it is also possible to extract a demand component of the resource's value for inclusion in a traditional demand/energy framework.

Many utilities classify the monthly guaranteed portion of payments to independent power producers as demand-related, using the archaic perspective that any generation cost that is committed for the rate year should be considered fixed and therefore demand-related, thus leading to great controversy in choosing the appropriate basis for allocation of demand-related costs. In reality, the utility may have agreed to the payment structure because of the low-cost energy provided by the deal, with that financial commitment having value to the resource owner in obtaining financing.

Others classify purchased power to mimic the classification of generation plant, as if the purchase were the equivalent of plant capital, without fuel.<sup>121</sup> This treatment is similarly inconsistent with cost causation. Many power purchase agreements are structured to recover the costs of a baseload or intermediate resource, such as by charging a relatively high nonbypassable capacity charge and a low energy charge based on the usage of the resource. These contracts are typically not the lowest-cost way to meet peak loads. The only rational reason to enter into these contracts

120 Xcel Energy touted its renewable energy investments as “steel for fuel,” in which “capital recovery costs [are] offset by lower fuel and O&M costs” and wind “displaces coal and natural gas fuel,” resulting in “significant customer savings” (2018). MidAmerican Energy justified its aggressive wind generation plan on eliminating exposure to fossil fuel costs (Hammer, 2018). Northern Indiana Public Service Co. found that replacing its coal plants’ fuel and operating costs with wind and solar would reduce customer costs, uncertainty and risk (2018, p. 6).

121 The contract may require the purchaser to take all of the available energy, so even a rate denominated in MWhs can be thought of as investment-related and thus similar to generation plant costs. In reality, the purchase contract replaces both the investment-related and variable costs of a comparable resource built by the purchasing utility.

would be to access lower-priced energy and higher efficiency. The classification process should look beyond the contract pricing terms to ascertain the true cost causation factors and where the benefits accrue.

Within the centrally dispatched power pools (such as the New England, New York, California and Midcontinent ISOs), utilities and other load-serving entities purchase energy on an hourly basis to meet their loads. The transactions are priced at the marginal costs of the supply bids to the system operator and cover some investment-related costs for most generators. The cost of those purchases should be classified as energy and allocated to loads on a time-differentiated basis.<sup>122</sup>

Costs for purchased power can be classified in most of the same ways that the costs of utility-owned generation are classified, including the probability-of-dispatch, equivalent peaker and average-and-peak methods and many others. In many cases, the purchase will be from a specific plant whose investment and nondispatch O&M costs can be allocated in the same manner as the costs of similar resources the utility owns. In other cases, such as system power, the classification and allocation of power purchase costs will need to be based on the cost characteristics of the purchase.<sup>123</sup> Where possible, the most straightforward classification approach would be to treat as energy-related the excess of the purchase costs over the capacity costs of a contemporaneous gas turbine peaking plant.

### Energy Storage

Energy storage takes many forms, including:

- Water held in conventional hydro reservoirs.
- Pumped storage hydro facilities.
- A variety of battery technologies, which may be co-located with generation, transmission or distribution facilities or be behind the customer's meter.
- A host of other electricity storage technologies, including

compressed air, flywheels and gravity (moving weights upward to store energy, using the potential energy to drive a generator as needed).

- Thermal storage as molten salt in solar thermal plants, ice or hot water at customer premises.

Batteries will be an increasingly important part of utility systems, and therefore of cost allocation studies, because of their flexibility and the rapid and continuing decline in their costs. Batteries can be installed (1) at the location of generation to stabilize or optimize output to the transmission system; (2) at substations to avoid transmission and distribution costs; or (3) throughout the system, on the utility or customer side of the meter to avoid transmission and distribution costs and to provide customer emergency power.

Batteries can provide a range of services, including contributing to bulk supply reliability, ancillary services (load following, reserves and automatic generator control), energy arbitrage, transmission load relief, distribution load relief and customer emergency supply. To the extent that the allocation study can reflect these various services, it should classify the costs of the batteries in proportion to their value. That classification may be based on the frequency with which the storage is used for each purpose, on the anticipated mix of benefits that justified the installation, or on the incremental cost incurred to achieve the additional purpose.<sup>124</sup> Batteries may be very valuable for providing second-contingency support to the transmission system (avoiding the installation of redundant equipment), even if they may never actually be dispatched for that purpose. Where utilities purchase some attributes of behind-the meter batteries, such as ancillary services, the services they purchase should drive the cost allocation.

Storage operates as both a load and a supply resource and thus may operate at very different times than conventional generation. As a result, storage fits well into hourly allocation

122 Some utilities in these pools own generation, which is sold into the regional market. The revenue from those sales can be credited against the costs of the generator before those costs are allocated to classes.

123 Since costs for purchased power may be recovered through both base rates and a power cost recovery mechanism, and the allocation of these costs may be reflected in both base rates and the power-cost mechanism, some care should be taken to ensure that the allocation is applied only once, just as the costs are recovered only once. For example, the costs for purchased power may be included in the cost of service study, with the anticipated purchased-power revenues from each class subtracted from

the allocated costs. Alternatively, the purchase costs may be excluded from the base rate cost of service study and allocated separately on an appropriate basis in the fuel and purchased power cost recovery mechanism.

124 Renewable incentives and tax policy may encourage co-location of storage with centralized renewable generation. Moving the storage to support transmission, distribution or customer resilience would typically increase both the value and the cost of the resource; those incremental costs should be classified as due to the incremental service.

schemes. Storage usually delivers power into the grid at high-cost hours, so assigning the capital and operating costs, including the costs of charging storage, to those hours usually will result in an equitable tracking of costs to benefits.

But storage also provides some services while it is charging, including operating reserves. A 200-MW pumped storage unit can typically transition from being a 200-MW pumping load to a 200-MW supply within minutes, providing 400 MWs of net operating reserves at no incremental cost during low-cost hours, allowing avoidance of fuel costs for load-following resources. Storage may also provide other ancillary services while charging. If the cost of service study is sophisticated enough to classify and allocate ancillary services separately from demand and energy, some of the storage costs can be classified to ancillary service, reflecting the increased reserves available during charging.

In addition, some utility systems experience high ramp rates in net load at times that variable renewable generation is declining and load is rising, such as an evening-peaking utility with a large amount of solar generation in the midday period. To be able to ramp up output from other generation quickly enough to offset the drop in renewable output and meet the rising load, the system may require the construction of additional resources and the uneconomic operation of thermal generators at low-load times to ensure they are available when the ramping need arises. Storage-charging load in the period of minimum net load (which is also likely to be a period of low or even negative short-run marginal costs) raises the minimum load and reduces the ramp rate. These benefits flow to the loads during the ramping period, not just during the discharge period, so some of the costs of storage should be allocated to those loads.

### System Control and Dispatch

The costs of scheduling, committing and dispatching generation units, recorded in FERC Account 556, are fixed in the short term but vary with the generation mix, load shapes and variability and other considerations. Costs of forecasting

load and supply and optimizing dispatch may vary depending on the amount of weather-related load, the existence of large loads and large generators that may suddenly trip off line, the extent of integration with other utilities, the length of time required for major plants to start up and the amount of variable renewable generation. Some dispatch costs would be required, even if the utility only needed to dispatch generation on a few peak hours, while others are required for multiday planning, 24-hour operation and other energy-related factors.

These costs might most reasonably be classified as partly demand-related and partly energy-related. Reasonable approaches would include classification of dispatch costs in proportion to the classification of long-term generation costs, using the average-and-peak method or a 50/50 split between energy and demand.

### 9.1.5 Summary of Generation Classification Options

Table 19 on the next page summarizes some attributes of the generation classification options described above. These descriptions are highly simplified and should be read in context of the discussion prior, including the discussion of special situations in Subsection 9.1.4.

## 9.2 Allocating Energy-Related Generation Costs

Energy-classified generation costs are often allocated to all classes in proportion to total annual class energy consumption. Alternatively, energy-related costs can be calculated by time period and allocated to classes in proportion to their usage in each time period. Assigning costs to time periods is usually straightforward for fuel and dispatch O&M.<sup>125</sup> For systems with high penetration of variable renewables, such as wind and solar, then TOU or BIP allocation of energy-related costs is the most equitable.

The energy-related capital investment and nondispatch O&M costs can be allocated to classes in proportion to

<sup>125</sup> One possible complication with time differentiation is that some steam plants must be operated in low-load hours, when they are not really needed, so that they will be available when needed in higher-load hours. The costs of fuel and reagents used in low-load hours may be required to

serve high-load hours, but the plants may also be supplying energy in the low-load hours; sorting out generation and fuel use among periods within a week or day can be very complicated.

**Table 19. Attributes of generation classification options**

Method	Data and computational intensity	Accuracy of cost causality	Allows joint classification/ allocation	Applicability
<b>Straight fixed/variable</b>	Very low	Very low	No	Peaker-only systems
<b>Competitive proxy</b>	Low	Medium	No	In or near regional transmission organizations that perform revenue computations
<b>Average and peak</b>	Low	Low	No	Hydro systems
<b>Simple base-intermediate-peak</b>	Low to medium	Medium	No	Simple systems: limited hydro, solar, wind, storage
<b>Complex base-intermediate-peak</b>	High	High	Yes	Broad
<b>Equivalent peaker (peak credit)</b>	Low	High	No	Broad
<b>Operational characteristics (capacity value, capacity factor, operating factor)</b>	Generally low	Low to medium	No	Limited
<b>Probability of dispatch</b>	Medium to high	Highest	Yes	Broad
<b>Decomposition</b>	Very high	Low	Yes	Rarely

energy or assigned among time periods in proportion to the fuel and dispatch O&M. Table 20 provides an illustration of the development of energy-classified costs per MWh (both dispatch- and investment-related) over three time periods.

Table 21 on the next page shows an illustrative example applying these costs per MWh to usage for three customer classes by time period to allocate costs.

The comparable computation for most utilities could use

many more periods (perhaps even hourly data), include all resource types and compute usage by generation unit, rather than category.

Manitoba Hydro, which has an almost all-hydro system, assigns energy-classified capital investment costs among four seasons and three time periods (for a total of 12 periods) in proportion to the MISO market prices for exports in those periods, reflecting the reality that there are hours in which

**Table 20. Illustrative example of energy-classified cost per MWh by time of use**

	Energy-related cost per MWh	Capacity (MWs)	Period (and annual hours)			Total
			Peak (50)	Midpeak (2,000)	Off-peak (6,710)	
<b>Resource type</b>						
Nuclear	\$30	500	\$750,000	\$28,500,000	\$90,585,000	\$119,835,000
Coal	\$40	1,500	\$3,000,000	\$84,000,000	\$161,040,000	\$248,040,000
Combined cycle	\$35	1,000	\$1,750,000	\$35,000,000	\$0	\$36,750,000
Peaking	\$100	300	\$1,500,000	\$12,000,000	\$0	\$13,500,000
Demand response	\$250	100	\$1,250,000	\$0	\$0	\$1,250,000
Subtotal of all resources			\$8,250,000	\$159,500,000	\$251,625,000	\$419,375,000
<b>Consumption (MWhs)</b>			170,000	4,170,000	7,045,500	11,385,500
<b>Cost per MWh</b>			\$48.53	\$38.25	\$35.71	\$36.83

Note: Numbers may not add up to total because of rounding. The illustration assumes that all resources are fully utilized in the peak period, with reductions in capacity factor between periods by 5 percentage points for nuclear, 30 points for coal, 50 points for combined cycle and 80 for peaking.

**Table 21. Illustrative example of time-of-use allocation of energy-classified costs**

	Period (and annual hours)			Total
	Peak (50)	Midpeak (2,000)	Off-peak (6,710)	
<b>Consumption (MWhs)</b>	170,000	4,170,000	7,045,500	11,385,500
<b>Cost per MWh</b>	\$48.53	\$38.25	\$35.71	\$36.83
<b>Class</b>				
<b>Residential</b>				
Consumption (MWhs)	69,250	2,080,000	2,818,200	4,967,450
Allocated costs	\$3,360,662	\$79,558,753	\$100,650,000	\$183,569,415
<b>Commercial</b>				
Consumption (MWhs)	85,000	1,460,000	2,113,650	3,658,650
Allocated costs	\$4,125,000	\$55,844,125	\$75,487,500	\$135,456,625
<b>Industrial</b>				
Consumption (MWhs)	15,750	630,000	2,113,650	2,759,400
Allocated costs	\$764,338	\$24,097,122	\$75,487,500	\$100,348,961

Note: Numbers may not add up to total because of rounding.

transmission constraints preclude additional exports. That approach recognizes that using energy in some time periods is more expensive for Manitoba Hydro (in terms of lost export revenues) than consumption in other time periods.

### 9.3 Allocating Demand-Related Generation Costs

As discussed in Subsection 9.1.3, some classification methodologies, such as probability of dispatch and more granular hourly variants, simultaneously develop cost by period and the associated allocation factors driven by use by period. This section describes methods for developing allocation factors for demand-related costs developed by legacy demand/energy classification methods.

Typically, utilities allocate demand-related generation based on some form of class contribution to system peak loads, referred to as coincident peak. The loads that determine how much capacity a utility requires may be concentrated in a few hours a year, a few hours in each month, the highest 50 or 100 hours in the year, or some other measure of the loads stressing system reliability.

Frequently used demand allocators include:

- The class contributions to the annual system coincident peak (1 CP).

- The class contributions to three or four seasonal peaks (3 CP or 4 CP).
- The average of the class contributions to multiple high-load hours, such as:
  - The 12 monthly peaks (12 CP).
  - All hours with loads greater than a threshold, such as 80% to 95% of annual peak.
  - **Peak capacity allocation factor (PCAF)**, a technique developed in California that weights high-usage hours based on how close each hour is to the peak hour.
  - Hours with some expectation for loss of energy.
  - Hours in which the system is stressed (e.g., operating reserves are below target levels).

As discussed in Chapter 5, generation capacity requirements have always been driven by more than a few hourly loads. Moreover, with peak loads being offset by solar generation and expanding demand response available to serve the highest-load or highest-cost hours, capacity requirements are driven by an even broader group of hours, which should be reflected in the development of the demand allocation factors. Broader allocation factors also have the virtue of limiting the instability resulting from the use of a limited number of peak hours. For example, ERCOT experienced an annual peak in 2017 at approximately



69,500 MWs on July 28 at 5 p.m. However, there were 13 other hours within 2% of that annual peak in 2017, in the hours ending at 3 p.m. to 7 p.m. (Electric Reliability Council of Texas, 2018, and calculations by the authors). Changes in temperature or cloud cover could shift the peak load to any of those hours. The peak timing in the load data can be very important in determining the allocators. The residential class typically will have a greater share of a peak load occurring at 7 p.m. than one occurring at 3 p.m. or 4 p.m.<sup>126</sup>

Utilities have sometimes allocated generation demand costs on the class NCP at the system level.<sup>127</sup> This approach may have been roughly appropriate for some utilities serving distinct classes with peak demands in different seasons, such as winter-peaking ski resorts and summer-peaking irrigation pumping, with both seasons contributing to the need for generation capacity. The class NCP would not recognize whatever load the ski resorts' summer operations contribute to the pumping-dominated peaks and would allocate demand costs to other classes based on their summer or winter peaks — but not their contributions to either of the seasons' high-load hours. Since reliability computations and the need for generation capacity are driven by combined system load, some measure of the combined loads on the system is relevant. With the hourly data collection technologies now available, this class NCP approximation is no longer necessary.

Traditionally, without access to the kind of sophisticated hourly data we can obtain today, utilities have tended to allocate demand costs on a single annual coincident peak,

the average of the four monthly peaks in the high-load summer season, the average of some number of summer and winter monthly peaks, a defined number of peak hours when peaking resources are expected to operate, or the average of the 12 monthly peaks.<sup>128</sup> The number of months included in the computations of the demand allocator often reflects the following factors:

- The number of months in which the system may experience its annual peak load.
- Whether high loads occur in both summer and the winter.
- Whether requirements for maintenance outages reduce available capacity in off-peak months enough that available reserves in those months are comparable to the reserves in the peak months.

A more comprehensive approach to these factors would develop the demand allocator from all the hours identified in a loss-of-energy expectation study, after accounting for maintenance scheduling. Depending on the system, that may be several hours or several hundred hours. If data are not available for a comprehensive loss-of-energy expectation analysis, a demand allocator based on all hours within a specified percentage of the peak (e.g., 80% to 95%) or based on a significant number of the highest hours in the year (e.g., 100) is preferable to a coincident peak analysis. In sum, averaging or weighting a small number of coincident peaks incorrectly assumes that the need for capacity is a simple function of the amount of the system monthly peak, even though capacity requirements are driven by many hours,

126 The range of loads in these 14 hours was only about 1,400 MWs, roughly the size of one large nuclear unit or two large coal units. The differences in loads over those hours are of little significance in terms of reliability.

127 In some jurisdictions, the class NCP is referred to as the maximum class peak, maximum diversified demand or something similar, and "NCP" is used to designate the sum of the individual customer noncoincident peaks within each class. We refer to class NCP and customer NCP in this manual to distinguish between the two methods.

128 FERC has a set of guidelines for determining whether wholesale demand-classified costs should be allocated on 3 CPs or 12 CPs (for example, see Federal Energy Regulatory Commission, 2008, pp. 30-35). FERC's approach does not contemplate that any other number of months (such as four or eight) might be responsible for the need for capacity.

Table 22. Attributes of generation demand allocation options

Method	Data and computational intensity	Accuracy of cost causality	Allows joint classification/ allocation	Applicability
<b>1 CP</b>	Very low	Very low	No	Rare
<b>3 CP; 4 CP</b>	Low	Low	No	One-season peak; needle peaks
<b>12 CP</b>	Low	Low to medium	No	Multiple seasonal peaks; extensive maintenance requirements; class load shapes near peak similar
<b>Multiple hours near peak (e.g., top 100 hours)</b>	Low to medium	Medium	No	Broad, but loss-of-energy expectation gives more robust results if data exist to calculate them
<b>Loss-of-energy expectation</b>	High	High	No	Broad
<b>Complex base-intermediate-peak</b>	High	High	Yes	Broad
<b>Probability of dispatch</b>	Medium to high	High	Yes	Broad

depending on load; the amount of generation capacity that is available, not just installed; and the scheduling of maintenance outages.

Table 22 summarizes some characteristics of the allocation methods described in this section, along with the POD method described in Subsection 9.1.3 and the more complex variants of the BIP method from Subsection 9.1.2.

## 9.4 Summary of Generation Allocation Methods and Illustrative Examples

As demonstrated in many ways in the previous sections, it is appropriate to classify some of the long-term investment and

O&M costs to energy usage rather than to demand. Table 23 presents a simplified view of appropriate classification results by plant type.

As variable renewable capacity (mostly wind and solar) on a system increases, the role for baseload capacity decreases. At some point, in hours with low load and high renewable output, traditional baseload resources will run only if they cannot shut down and restart on a timely basis.

Cost of service studies can also combine features of the various classification approaches, such as classifying peakers as 100% demand-related; classifying fuel conversion costs, environmental costs and generation without firm transmission as 100% energy-related; and applying the average-and-peak

Table 23. Summary of conceptual generation classification by technology

Resource type	Function	Classification
<b>Nuclear, some hydro and best coal</b>	Baseload	Primarily energy
<b>Modern combined cycle, best gas-fired steam and mediocre coal</b>	Intermediate	Energy and demand
<b>Combustion turbines, mediocre fossil-fueled steam and combined cycle</b>	Peaking and operating reserves	Primarily demand or on-peak energy
<b>Storage and flexible hydro</b>	Peaking and energy shifting	Demand or on-peak energy
<b>Wind and solar</b>	Energy and some capacity	Primarily energy

Note: "Best" refers to resources with the lowest variable costs, "mediocre" to those with higher variable costs. Resources that are worse than mediocre are likely candidates for retirement. "Intermediate" refers to generation that is neither baseload nor peaking.

**Table 24. Summary of generation allocation approaches**

Resource type	Classification and allocation methods		
	Legacy	Modern	Evolving
<b>Nuclear</b>	CLASSIFICATION: Average and peak ENERGY ALLOCATOR: All energy DEMAND ALLOCATOR: 12 CP	CLASSIFICATION: Equivalent peaker ENERGY ALLOCATOR: All energy DEMAND ALLOCATOR: Loss-of-energy expectation	All hours
<b>Baseload coal</b>	CLASSIFICATION: Average and peak ENERGY ALLOCATOR: All energy DEMAND ALLOCATOR: 12 CP	Probability of dispatch	Hours dispatched
<b>Combined cycle</b>	CLASSIFICATION: Average and peak ENERGY ALLOCATOR: All energy DEMAND ALLOCATOR: 12 CP	Probability of dispatch	Hours dispatched or used for reserve
<b>Gas-fired steam</b>	CLASSIFICATION: Average and peak ENERGY ALLOCATOR: On-peak energy DEMAND ALLOCATOR: 4 CP*	Probability of dispatch	Hours dispatched or used for reserve
<b>Peaker</b>	CLASSIFICATION: 100% demand DEMAND ALLOCATOR: 4 CP or 12 CP	Probability of dispatch	Hours dispatched or used for reserve
<b>Hydro</b>	CLASSIFICATION: Average and peak ENERGY ALLOCATOR: All energy DEMAND ALLOCATOR: 12 CP*	Probability of dispatch	Hours dispatched or used for reserve
<b>Wind</b>	CLASSIFICATION: 100% energy ENERGY ALLOCATOR: All energy	CLASSIFICATION: Equivalent peaker ENERGY ALLOCATOR: All energy DEMAND ALLOCATOR: Loss-of-energy expectation	Hours of output
<b>Solar</b>	CLASSIFICATION: Average and peak ENERGY ALLOCATOR: On-peak energy DEMAND ALLOCATOR: 4 CP	CLASSIFICATION: Equivalent peaker ENERGY ALLOCATOR: All energy DEMAND ALLOCATOR: Loss-of-energy expectation	Hours of output
<b>Storage</b>	CLASSIFICATION: Average and peak ENERGY ALLOCATOR: All energy DEMAND ALLOCATOR: 12 CP	Probability of dispatch	Hours dispatched, used for reserve or reducing ramp rate
<b>Demand response</b>	CLASSIFICATION: 100% demand DEMAND ALLOCATOR: 3 CP to 12 CP**	CLASSIFICATION: 100% demand DEMAND ALLOCATOR: 3 CP to 12 CP**	Hours dispatched or used for reserve

\* Depends on use of resource

\*\* Depends on program type and technology

approach to the remaining costs. A hybrid approach is only as equitable as the component techniques but may be useful where particular classification decisions can be made before the application of a generic approach to the residual costs.

Table 24 summarizes examples of allocation factors

that might be applied to the capital and nondispatch O&M costs for various types of generation resources, whether utility-owned or purchased.<sup>129</sup> This summary is, by its very nature, highly simplified, ignoring many of the complexities discussed in sections 9.1, 9.2 and 9.3.

129 The probability-of-dispatch and hourly approaches can also be applied to the short-run variable costs of the resources.

For simplicity, we show an illustration only for generation investment-related costs. Table 25 shows the amount of investment in each category, which we will then divide using multiple allocation methods.

Table 26 shows two currently used methods: a legacy 1 CP system measure and a more modern method, equivalent peaker, where 80% of baseload costs are considered to be energy-related. The illustrative load data and allocation factors are from tables 5 through 7 in Chapter 5.

Table 27 shows the calculation of an hourly allocation model, where baseload costs are apportioned to all hours, peaking and intermediate costs to midpeak hours, and storage only to the 2% of usage at the most extreme hours.

**Table 25. Illustrative annual generation data**

	Net generation (MWhs)	Annual nonfuel revenue requirement	Annual nonfuel cost per MWh
<b>Baseload</b>	1,860,000	\$74,400,000	\$40
<b>Peaker</b>	534,000	\$42,720,000	\$80
<b>Solar</b>	1,056,000	\$31,680,000	\$30
<b>Storage</b>	62,000	\$6,200,000	\$100
<b>Total</b>	3,512,000	\$155,000,000	\$44
Disposition of net generation			
<b>Storage input and delivery losses</b>	412,000		
<b>Sales to customers</b>	3,100,000		

Note: Numbers may not add up to total because of rounding.

**Table 26. Allocation of generation capacity costs by traditional methods**

	Residential	Secondary commercial	Primary industrial	Street lighting	Total
<b>1 CP (legacy)</b>	\$51,667,000	\$62,000,000	\$41,333,000	\$0	\$155,000,000
<b>Equivalent peaker</b>	\$50,333,000	\$52,400,000	\$47,750,000	\$4,517,000	\$155,000,000

Note: Numbers may not add up to total because of rounding.

**Table 27. Modern hourly allocation of generation capacity costs**

	Residential	Secondary commercial	Primary industrial	Street lighting	Total
<b>Baseload (all hours)</b>	\$24,000,000	\$24,000,000	\$24,000,000	\$2,400,000	\$74,400,000
<b>Peaker (midpeak)</b>	\$14,424,000	\$15,735,000	\$12,326,000	\$236,000	\$42,720,000
<b>Solar (daytime)</b>	\$10,560,000	\$12,320,000	\$8,800,000	\$0	\$31,680,000
<b>Storage (critical peak)</b>	\$2,366,000	\$2,366,000	\$1,420,000	\$47,000	\$6,200,000
<b>Total hourly allocation</b>	\$51,350,000	\$54,421,000	\$46,545,000	\$2,683,000	\$155,000,000
<b>Composite hourly factor</b>	33%	35%	30%	2%	100%

Note: Numbers may not add up to total because of rounding.

## 10. Transmission in Embedded Cost of Service Studies

As discussed in Chapter 3, investments in transmission lines and substations are needed and valuable for a wide assortment of purposes, including integrating inherently remote generation, allowing economic dispatch of generation over large areas and providing backup reliability. Any particular transmission line and the substations to which it is connected may perform multiple functions under varying load and generation conditions. Because the purposes for constructing transmission and the use of the facilities vary so widely, the allocation methods used may need to distinguish among several categories of transmission.

The generation-related portions of transmission equipment — including switching stations, substations and transmission lines required to tie generators into the general transmission network and reinforcements of the transmission system required by remote generation locations and by economic dispatch — are often functionalized as generation.

In regions with FERC-regulated ISOs or RTOs, state regulators may not have authority to determine the amount of bulk transmission cost a local distribution utility must pay. The states may choose to allocate costs among classes in a manner similar to that FERC uses to allocate costs among utilities and other parties. States also retain the authority to allocate that cost using a different method than FERC uses for wholesale market allocation.

### 10.1 Subfunctionalizing Transmission

As noted in Chapter 3, transmission of different voltage levels often serves similar functions. Nonetheless, some utilities have subfunctionalized transmission between **extra-high-voltage** (EHV) facilities (perhaps over 100 kV) and subtransmission (at lower voltages), sometimes called network transmission as it connects the different substations inside the utility service territory. Subtransmission that FERC

does not claim authority over (based on voltage, configuration, direction of power flow and other factors) is regulated by the state or consumer-owned utility governing body.

If those subfunctions were classified and allocated in the same manner, the division of the facilities by voltages would not matter. Unfortunately, some cost of service studies allocate only the EHV facilities to certain customers directly served from these facilities, with customers served at subtransmission or distribution voltages being charged for both the EHV system and the subtransmission. For example, in 2013, Nova Scotia Power proposed to functionalize 23% of transmission costs to subtransmission and excuse from those costs the largest industrial customers, served at 138 kV (Nova Scotia Power, 2013b). Similarly, Manitoba Hydro functionalizes its 66-kV and 33-kV transmission lines as subtransmission, which is allocated to all classes except for the industrial customers served at voltages above 66 kV (Manitoba Public Utility Board, 2016).

This approach is inequitable and fails to reflect cost causality. The various voltages of transmission serve complementary functions. In general, customers and distribution substations that are served from subtransmission would be more expensive to serve from EHV transmission. Subtransmission is a lower-cost alternative to EHV where the higher capacity of the EHV facilities is not required.

For some systems, the subtransmission and EHV systems may seem to be serving different functions since the EHV lines may be more often networked or looped, while the subtransmission lines are often radial. This pattern is due to the higher load-carrying capacity of the EHV lines, which results in their being used in high-load backbone configurations. These lines are usually networked for greater reliability, not due to some inherent difference in the capabilities of the technologies. Higher-voltage lines

can be used in radial applications, and subtransmission can be networked or looped in some situations.

Figure 36 is a section of a California transmission map, showing EHV lines as solid lines (220 to 287 kV) and large dashed lines (110 to 161 kV) and subtransmission as small dashed lines (California Energy Commission, 2014). This excerpt shows some features that are consistent with the proposition that higher-voltage transmission is networked while subtransmission is radial:

- A large backbone transmission line running north-south.
- A looped network of 110- to 161-kV lines coming off the backbone line into the Oakland area.
- Radial subtransmission lines that dead-end at distribution substations in Berkeley and parts of Oakland.

But Figure 36 also illustrates situations contradicting these stereotypes:

- Networked subtransmission lines in the San Leandro-San Lorenzo area.
- Radial 220- to 287-kV lines that dead-end at such substations as Rossmoor and Castro Valley.

Thus, the idea that the EHV system is a network and the subtransmission system is a purely radial system served off the EHV network is a gross simplification. If loads to near San Lorenzo were higher, for example, the local utility might have upgraded the subtransmission network to higher voltages.

As a result, the separation of subtransmission is often inappropriate in principle and impractical in application, leading to the conclusion that all voltages of transmission should be allocated consistently as a single function.

However, if a state determines that subtransmission costs are to be allocated to the classes that use the subtransmission system, ignoring the complementary nature of high- and low-voltage transmission, the allocator should approximate the

Figure 36. Transmission east of San Francisco Bay



Source: California Energy Commission. (2014). *California Transmission Lines – Substations Enlargement Maps*

extent to which each class uses the subtransmission system and not be designed simply as a benefit to high-voltage industrial customers.

Not all distribution loads are served from subtransmission. If industrial customers served directly off the EHV system are excused from being allocated a share of the subtransmission, so should the portion of distribution load served by substations that are fed from EHV transmission. Although segregating EHV facilities is typically performed in a manner that benefits a small number of EHV industrial customers, a full subfunctionalization of transmission for all classes would sometimes reduce the allocation to classes served at distribution, at the expense of the classes served directly from the subtransmission system.

A separate subtransmission allocator should approximate the following:

- An EHV industrial class that takes all its power from the EHV system would be allocated no subtransmission costs.
- A subtransmission industrial class that takes all its power from the subtransmission system would be allocated subtransmission costs in proportion to its entire load.
- A general transmission class would be allocated subtransmission costs in proportion to the fraction of its load served from subtransmission.
- The distribution classes would be allocated subtransmission costs in proportion to the fraction of their load served from substations on the subtransmission lines.

Most large utilities appear to serve a significant fraction of distribution load from the EHV system. The utility FERC Form 1 reports indicate that at least 26% of Southern California Edison's distribution substation capacity (the substations with low-side transformers below 30 kV) is served from the EHV system; for Northern Indiana Public Service, the portion is at least 49% (Federal Energy Regulatory Commission, n.d.).<sup>130</sup>

## 10.2 Classification

The classification of transmission costs raises many of the same issues as the classification of generation costs and can often be dealt with in similar ways. As for generation, some approaches for transmission avoid the need for classification by assigning specific transmission facilities to the loads occurring in the hours in which these lines serve customers with improved reliability, lower variable costs or other benefits.

Some assets that are carried on the books as transmission may actually be related to interconnecting or integrating

generation (step-up transformers and generation ties for many utilities; more extensive facilities for utilities with extremely remote generators). Those facilities can either be functionalized as generation-related and classified along with the generation resource or functionalized as transmission and classified in the same manner as the investment-related costs of the associated generation. Facilities connecting peakers should be treated as demand-related, while those connecting the baseload generation, especially remote generation, should be primarily treated as energy-related since the facilities were built primarily to provide energy benefits. For example, Manitoba Hydro classifies as entirely energy-related the high-voltage direct current system that brings its northern hydro generation to the southern load centers and export points, as well as its transmission interties, which allow for economic energy exports and for off-peak energy imports to firm up hydro supplies in drought conditions.<sup>131</sup>

In addition to the substations that step up the generator output to transmission voltages and the lines that connect the generator to the broader transmission network, many utilities have transmission facilities that are integrated with the transmission network but are driven largely by the need to move large amounts of power from remote generators. Those transmission facilities may be identifiable because they were originally required to reinforce the transmission system when major baseload (or remote hydro or wind) resources were added or because they connect areas that have surplus generation to areas with generation shortages. For example, a utility may have 60% of its load in a central metropolitan area but 80% of its baseload resources far to the east or north, with multiple major transmission lines connecting the resource-rich east with the load in the center.<sup>132</sup>

130 Some distribution substation transformers are at substations serving multiple transmission voltages. The FERC Form 1 reports provide only the total transformer capacity at the substation, without differentiating among the EHV-subtransmission, EHV-distribution and EHV-EHV capacity. The percentages of distribution capacity served from the EHV system, listed above, do not include any of this multivoltage capacity.

131 The northern AC gathering system that brings the hydro to the HVDC converters is also classified as energy-related.

132 Examples of this phenomenon include Nova Scotia Power's concentration of coal in the eastern end of the province; BC Hydro's, Manitoba Hydro's and Hydro-Quebec's northern generation; PacifiCorp's Rocky

Mountain Power division (with load concentrated around Salt Lake City and generation in Colorado, Wyoming, Arizona and Montana); Arizona Public Service Co. with load in Phoenix and generation in the Four Corners and Palo Verde areas; Puget Sound Energy and the Colstrip transmission system from Montana; the California utilities and the AC and DC interties to the Pacific Northwest and lines to the Southwest; and Texas' concentration of wind generation in the Panhandle, serving load throughout ERCOT. This pattern is also emerging for California's imports of solar energy from Nevada and Arizona, Minnesota's imports of wind power from North Dakota and hydro energy from Manitoba, and the transfers of large amounts of wind power from generation in the western parts of Kansas and Oklahoma to load centers in the eastern parts of those states.

Utility transmission system design typically lowers energy costs in at least three ways. First, a large portion of many transmission systems is required to move power from the remote generators to the load centers and for export. If generation were located nearer the load centers, the long, expensive transmission lines would not be required, and transmission losses would be smaller. These transmission costs were incurred as part of the trade-off against the higher operating costs of plants that could be located nearer the load centers — in other words, as a trade-off against energy-related costs. This category includes transmission built to allow the addition of remote wind resources, which are often the least-cost energy resources even where the utility already has sufficient capacity and energy supply. In other cases, the remote wind resources may be more expensive than conventional resources, new or existing, but less expensive than local renewables (e.g., solar, wind turbines in areas with lower wind speed, higher land costs and more complex siting problems) that would otherwise need to be built to comply with energy-related renewable energy standards.

Second, transmission systems are more expensive because they are designed to allow for large transfers of energy between neighboring utilities. Third, transmission systems are designed to minimize energy losses and to function over extended hours of high loading. Were the system designed only to meet peak demands, a less costly system would suffice; in some cases, entire lines or circuits would not be required, voltage levels could be lower, and fewer or smaller substations would be needed.

Figure 37 shows a simple illustrative system with relatively small units of a single generation resource co-located with each load center. Since all the generators are the same, economic dispatch does not require shipping power from one load center to another, so transmission is limited to the amount needed to allow reserve capacity in one center to back up multiple outages in another center. In this simple illustration, the transmission costs would truly be demand-related.

Figure 38 on the next page illustrates a more complex system, with baseload coal concentrated in one area, combined cycle generation in another and combustion

**Figure 37. Transmission system with uniformly distributed demand and generation**

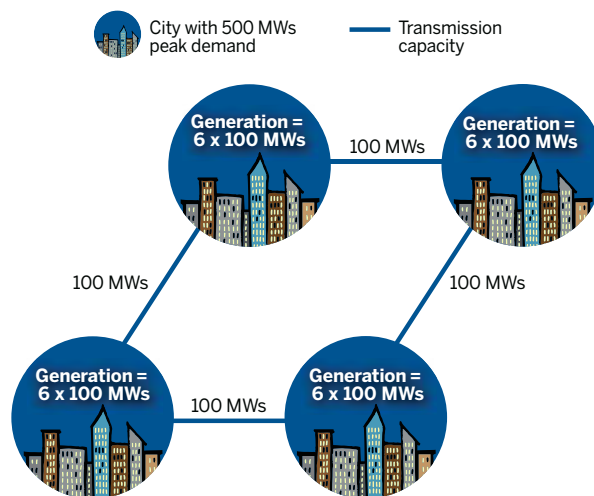

turbines in a third. Additional transmission corridors and substations are required to connect remote generation (wind from one direction and hydro from another), and the transmission lines between the load centers need to be beefed up to support backup of the larger units and the economic dispatch of the lowest-cost available generation to meet load. In this more complex system, the incremental costs of transmission (compared with the simple system in Figure 37) should be classified as energy-related.

It may be possible to identify and classify the costs of the individual lines or classify total costs in proportion to circuit-miles of each voltage serving various energy functions. If all else fails, a more judgment-based classification method, such as average and peak, may be the best feasible option.

PacifiCorp's Rocky Mountain Power subsidiary in Utah classifies transmission as 75% demand-related and 25% energy-related (Steward, 2014, p. 7). This classification recognizes that, although peak loads are a major driver of transmission costs, a significant portion of transmission costs is incurred to reduce energy costs. Since PacifiCorp has a large amount of transmission connecting remote coal plants in Wyoming, Arizona and Colorado to its load centers and connecting its Northwestern hydro assets to its load centers, an even higher energy classification may be



Figure 38. Transmission system with remote and centralized generation

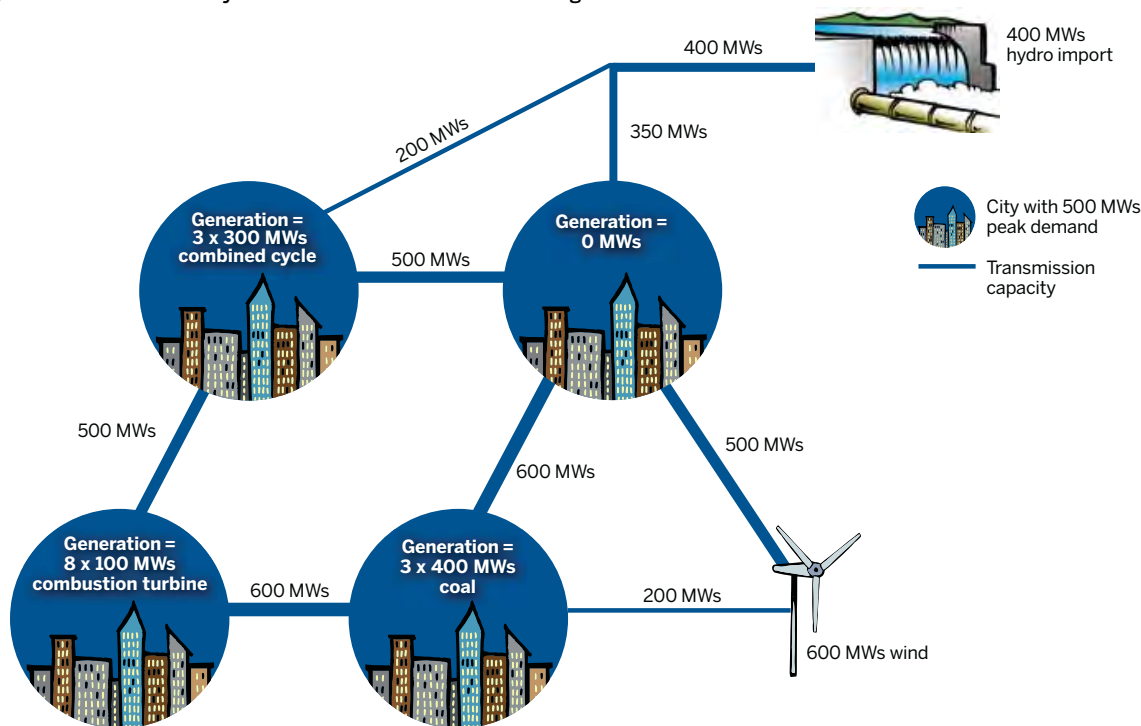

appropriate. PacifiCorp's highest-voltage lines (500 kV, 345 kV and 230 kV) primarily connect its load with remote baseload generation and would not be needed except to access low-cost energy. Those lines account for more than half of PacifiCorp's transmission investment. Hence, more than half of PacifiCorp's transmission revenue requirement is likely to be attributable to energy.

Similarly, Nova Scotia Power has much of its generation (coal plants, storage hydro and an HVDC import of hydropower from Newfoundland) in the eastern end of the province, but most of its load is about 250 miles to the west. To reflect the large contribution of remote generation to its transmission cost, the company uses an average-and-peak (system load factor) approach that effectively classifies about 62% to energy and 38% to demand (Nova Scotia Utility and Review Board, 2014, pp. 22-23).

Washington state has explicitly rejected a single hour of peak as a determinant and ruled that transmission costs

should be classified to both energy and demand (Washington Utilities and Transportation Commission, 1981, p. 23). Appropriate classification percentages will vary among utilities and transmission owners.

### 10.3 Allocation Factors

Historically, most cost of service studies have computed transmission allocation factors from some combination of monthly peak demands from 1 CP to 12 CP.

Some utilities have recognized that transmission investments are justified by loads in more than one hour in a month. For example, Manitoba Hydro has used a transmission allocator computed from class contribution to the highest 50 hours in the winter, Manitoba Hydro's peak period, and the highest 50 hours in the summer, the period of Manitoba Hydro's maximum exports, which also drive intraprovincial transmission construction (Manitoba Hydro, 2015, Appendix 3.1, p. 9).

The hours of maximum transmission loads may be different from the hours of maximum generation stress. For example, the power lines from remote baseload units to the load centers may be most heavily loaded at moderate demand levels. At high load levels, more of the low-cost remote generation may be used by load closer to the generator, while higher-cost generation in and near the load centers increases, reducing the long-distance transmission line loading. In addition, generator maintenance does not necessarily smooth out transmission reliability risk across months in the same way that it spreads generation shortage risk. If transmission loads peak in winter, when carrying capacity is higher, then transmission peaks may not match even the maximum transmission stress period.

In its Order 1000, establishing regional transmission planning and cost allocation principles, FERC includes the following cost allocation principles, which recognize that transmission is justified by multiple drivers and that different allocation approaches may be justified for different types of transmission facilities:

(1) The cost of transmission facilities must be allocated to those ... that benefit from those facilities in a manner that is at least roughly commensurate with estimated benefits. In determining the beneficiaries of transmission facilities, a regional transmission planning process may consider benefits including, but not limited to, the extent to which transmission facilities, individually or in the aggregate, provide for maintaining reliability and sharing reserves, production cost savings and congestion relief, and/or meeting public policy requirements established by state or federal laws or regulations that may drive transmission needs. ...

(5) The cost allocation method and data requirements for determining benefits and identifying beneficiaries for a transmission facility must be transparent with adequate documentation to allow a stakeholder to determine how they were applied to a proposed transmission facility.

(6) A transmission planning region may choose to use a different cost allocation method for different types of transmission facilities in the regional plan, such as transmission facilities needed for reliability, congestion relief or to achieve public policy requirements established by state or federal laws or regulations (Federal Energy Regulatory Commission, 2011, ¶ 586).

The FERC guidance clearly anticipates differential treatment of transmission facilities built for different purposes. Aligning costs with benefits may require allocation of transmission costs to most or all hours in which a transmission facility provides service.<sup>133</sup>

Demand-related transmission costs may be allocated to hours in proportion to the usage of the lines or to the high-load hours in which transmission capacity may be tight following a contingency (the failure of some part of the system) or two. The high-load hours may be chosen as a more or less arbitrary number of the highest hours, as in Manitoba, or as the hours in which loads on a particular line or substation are high enough that the worst-case planning contingency (such as the loss of two lines) would leave the transmission system with no more reserve than it has on the system peak with no contingencies.<sup>134</sup>

## 10.4 Summary of Transmission Allocation Methods and Illustrative Examples

The discussion above has indicated why transmission investments must be carefully scrutinized in the cost allocation process. Different transmission facilities provide different services and are thus appropriately allocated by different allocation methods. Table 28 on the next page lists some types of transmission facilities and identifies appropriate methods for each.

Transmission is a very difficult challenge for the cost analyst because each transmission segment may have a

133 Attributing transmission to hours is more complicated than assigning generation costs by hours, because of the flow of electricity in a network. Once a transmission line is in service, power will flow over it any time there is a voltage differential between the ends of the line, whether or not the line was in any way needed to meet load in that hour.

134 The latter definition would require load flow modeling for each transmission line or a representative sample; the practicality of this approach will depend on the extent of transmission modeling undertaken for system planning.

**Table 28. Summary of transmission classification and allocation approaches**

Element	Example methods	Comments	Hourly allocation
<b>Bulk transmission</b>	CLASSIFICATION: To energy* — costs to allow centralized generation and economic dispatch; cost due to heating ENERGY ALLOCATOR: All energy DEMAND ALLOCATOR: Highest 100 hours	<ul style="list-style-type: none"> <li>Typically above 150 kV</li> <li>Mostly bidirectional</li> <li>Operates in all hours</li> </ul>	Allocate in proportion to usage or hours needed
<b>Integration of remote generation</b>	CLASSIFICATION: To energy* — costs to connect remote energy resources ENERGY ALLOCATOR: All energy DEMAND ALLOCATOR: Highest 100 hours	Treat same as connected remote resources	Allocate in same manner as remote resources
<b>Economy interconnections</b>	CLASSIFICATION: Energy and demand	Depends on purpose and use of connection	<ul style="list-style-type: none"> <li>Allocate reliability value as equivalent peaker</li> <li>Allocate energy value in proportion to use</li> </ul>
<b>Local network</b>	CLASSIFICATION: To energy* — cost due to heating ENERGY ALLOCATOR: On-peak energy DEMAND ALLOCATOR: 4 CP to 12 CP	<ul style="list-style-type: none"> <li>Typically below 150 kV</li> <li>Mostly radial</li> </ul>	Allocate in proportion to usage or hours needed
<b>Transmission substations</b>	As lines**	May also have distribution functions	As lines**

\* "To energy" = portion classified as energy-related

\*\* "As lines" = in proportion to the classification or allocation of the lines served by each substation

different history and purpose and that purpose may have changed over time. For example, a line originally built to connect a baseload generating unit that has since been retired is repurposed to facilitate economic energy interchange with nearby utilities. In Table 29, we use only three methods, which may or may not be relevant to

particular types of transmission costs, including purchased transmission service from another utility, a transmission-owning entity or an ISO. The illustrative data for the 1 CP and equivalent peaker methods are from tables 5 through 7 in Chapter 5, and the hourly allocation factor is derived in Table 27 in Chapter 9.

**Table 29. Illustrative allocation of transmission costs by different methods**

	Residential	Secondary commercial	Primary industrial	Street lighting	Total
<b>1 CP (legacy)</b>	\$16,667,000	\$20,000,000	\$13,333,000	\$0	\$50,000,000
<b>Equivalent peaker</b>	\$16,237,000	\$16,903,000	\$15,403,000	\$1,457,000	\$50,000,000
<b>Hourly</b>	\$16,565,000	\$17,555,000	\$15,015,000	\$866,000	\$50,000,000

Note: Numbers may not add up to total because of rounding.

# 11. Distribution in Embedded Cost of Service Studies

**D**istribution costs are all incurred to deliver energy to customers and are primarily investment-related costs that do not vary in response to load in the short term. Different rate analysts approach these costs in very different ways. These costs are often divided into two categories.

- i. Shared distribution, which typically includes at least:
  - Distribution substations, both those that step power down from transmission voltages to distribution voltages and those that step it down from a higher distribution voltage (such as 25 kV) to a lower voltage (such as 12 kV).
  - Primary feeders, which run from the substations to other substations and to customer premises, including the conductors, supports (poles and underground conduit) and various control and monitoring equipment.
  - Most line transformers, which step the primary voltage down to secondary voltages (under 600 V, and mostly in the 120 V and 240 V ranges) for use by customers.
  - A large portion of the secondary distribution lines, which run from the line transformers to customer service lines or drops.
  - The supervisory control and data acquisition equipment that monitors the system operation and records system data. This is a network of sensors, communication devices, computers, software and typically a central control center.
2. Customer-specific costs, which include:
  - Service drops connecting a customer (or multiple customers in a building) to the common distribution

system (a primary line, a line transformer or a secondary line or network).

- Meters, which measure each customer's energy use by month, TOU period or hour and sometimes by maximum demand in the month.<sup>135</sup> Advanced meters can also provide other capabilities, including measurement of voltage, remote sensing of outages, and remote connection and disconnection.<sup>136</sup>
- Street lighting and signal equipment, which usually can be directly assigned to the corresponding rate classes.
- In some systems with low customer spatial density, a significant portion of primary lines and transformers serving only one customer.

## 11.1 Subfunctionalizing Distribution Costs

One important issue in cost allocation is the determination of the portion of distribution cost that is related to primary service (the costs of which are allocated to all customers, except those served at transmission voltage) as opposed to secondary service (the costs of which are borne solely by the secondary voltage customers — residential, some C&I customers, street lighting, etc.).

Some plant accounts and associated expenses are easily subfunctionalized. Substations (which are all primary equipment) have their own FERC accounts (plant accounts 360 to 362, expense accounts 582 and 592). In addition, distribution substations take power from transmission lines and feed it into the distribution system at primary voltage. All distribution substations deliver only primary power and therefore should be subfunctionalized as 100% primary.

<sup>135</sup> The Uniform System of Accounts treats meters as distribution plant and the costs of keeping the meters operable as distribution expenses, even though all other metering and billing costs are treated as customer accounts or A&G plant or expenses. Traditional meters that tally only customer usage are not really necessary for the operation of the distribution system, only for the billing function. As a result, references to meters in this chapter are quite limited, and the costs of meters are

discussed with meter reading and billing in the next chapter.

<sup>136</sup> These capabilities require additional supporting technology, some of which is also required to provide remote meter reading. These costs should be spread among a variety of functions, including distribution and retail services, as discussed in Section 11.5.

However, many other types of distribution investments pose more difficult questions. The FERC accounts do not differentiate lines, poles or conduit between primary and secondary equipment, and many utilities do not keep records of distribution plant cost by voltage level. This means any subfunctionalization requires some sort of special analysis, such as the review of the cost makeup of distribution in areas constituting a representative sample of the system.

Traditionally, most cost of service studies have functionalized a portion of distribution poles as secondary plant, to be allocated only to classes taking service at secondary voltage. This approach is based on misconceptions regarding the joint and complementary nature of various types of poles. Although distribution poles come in all sorts of sizes and configurations, the important distinction for functionalization is what sorts of lines the poles carry: only primary, both primary and secondary or only secondary. The proper functionalization of the first category — poles that carry only primary lines — is not controversial; they are required for all distribution load, the sum of load served at primary and the load for which power is subsequently stepped down to secondary.<sup>137</sup>

For the second category — poles carrying both primary and secondary lines — some cost of service studies have treated a portion of the pole cost as being due to all distribution load and the remainder as being due to secondary loads, to be allocated only to classes served at secondary voltage. There is no cost basis for allocating any appreciable portion of these joint poles to secondary. The incremental pole cost for adding secondary lines to a pole carrying primary is generally negligible. The height of the pole is determined by the voltage of the primary circuits it carries, the number of primary phases and circuits and the local topography. Much of the equipment on the poles (cross arms, insulators, switches and other monitoring and control equipment) is used only for the primary lines. The required strength of the pole (determined by the diameter and material) is determined by the weight of the lines and equipment and by the leverage exerted by that weight (which increases with the height of the equipment

and the breadth of the cross arms, again due to primary lines).<sup>138</sup> Equipment used in holding secondary lines has a very low cost compared with those used for primary lines. If the poles currently used for both secondary and primary lines had been designed without secondary lines, the reduction in costs would be very small. Thus, the costs of the joint poles are essentially all due to primary distribution.

Although nearly all poles carry primary lines, a utility sometimes will use a pole just to carry secondary lines, such as to reach from the last transformer on a street to the last house, or to carry a secondary line across a wide road to serve a few customers on the far side. Secondary-only poles are usually shorter and skinnier and thus less expensive than primary poles and do not require cross arms and other primary equipment. Some cost of service studies functionalize a portion of pole costs to secondary, based on the population of secondary-only poles (either from an actual inventory or an estimate) or of short poles (less than 35 feet, for example), on the theory that these short poles must carry secondary.

The assumption that all short poles carry secondary is not correct; some utility poles carry no conductor but rather are stubs used to counterbalance the stresses on heavily loaded (mostly primary) poles, as illustrated in Figure 39 on the next page. Depending on the nature of the distribution system and the utility's design standards, the number of stub poles may rival the number of secondary-only poles.

Where only secondary lines are needed, the utility typically saves on pole costs due to the customer taking secondary service, rather than requiring primary voltage service and a bigger pole. Some kind of pole would be needed in that location regardless of the voltage level of service. Hence, the primary customers are better off paying for their share of the secondary poles than if the customers using those poles were to require primary service. It does not seem fair to penalize customers served at secondary for the fact that the utility is able to serve some of them using a type of pole that is less expensive than the poles required for primary service.

As a result, the vast majority of pole costs (other than for

137 The class loads should be measured at primary voltage, including losses, which will be higher for power metered at secondary.

138 There is one situation in which secondary distribution can add to the cost of poles. A very large pole-mounted transformer (perhaps over 75 kVA)

may require a stronger pole, which would be a secondary distribution cost. A highly detailed analysis of pole subfunctionalization might thus result in a portion of the cost of those few poles being treated as an extra cost of secondary service, offset to some extent by the savings from some poles being designed to carry only secondary lines.

**Figure 39. Stub pole used to guy a primary pole**

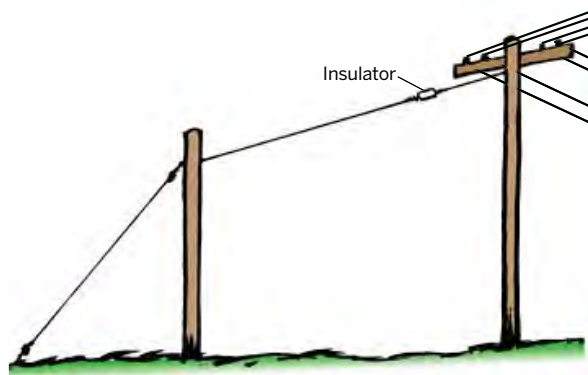

dedicated poles directly assigned to street lighting or similar services) generally should be treated as serving all distribution customers.<sup>139</sup> For many cost of service studies, that would result in the costs being subfunctionalized as primary distribution, which is then allocated to classes in proportion to their contribution to demand at the primary voltage level.

Line transformers dominate two FERC accounts (plant account 368 and expense account 595), but those accounts also include the costs of capacitors and voltage regulators. These three types of equipment should be subfunctionalized in three different manners:

- Secondary line transformers (which compose the bulk of these accounts) are needed only for customers served at secondary voltage and thus can be subfunctionalized as 100% secondary.
- Voltage regulators are devices on the primary system that adjust voltage levels along the feeder to keep delivered voltage within the design range. The number and capacity of voltage regulators is determined by the distribution of load along the feeder, regardless of whether that load is served at primary or secondary. The regulator costs should be subfunctionalized as primary distribution and classified in the same manner as substations and primary conductors.
- Capacitors improve the power factor on distribution lines at primary voltage, thus reducing line losses (reducing generation, transmission and distribution costs), reducing voltage drop (avoiding the need for

larger and additional primary conductors) and increasing primary distribution line capacity. Capacitors can be functionalized as some mix of generation, transmission and primary distribution; in any case they should be functionalized separately from line transformers.

Overhead and underground conductors as well as conduit must be subfunctionalized between primary and secondary using special studies of the composition of the utility's distribution system, since secondary conductors are mostly incremental to primary lines. Estimates of the percentage of these investments that are secondary equipment typically range from 20% to 40%.

Within the primary conductor category, utilities use three-phase feeders for areas with high loads and single-phase (or occasionally two-phase) feeders in areas with lower loads. The additional phases (and hence additional conductors) are due to load levels and the use of equipment that specifically requires three-phase supply (such as some large motors), which is one reason that primary distribution is overwhelmingly load-related and should be so treated in classification.

Some utilities subfunctionalize single- and three-phase conductors, treating the single-phase lines as incremental to the three-phase lines (see, for example, Peppin, 2013, pp. 25-26). Classes that use a lot of single-phase lines are allocated both the average cost of the three-phase lines and the average cost of the single-phase lines. This treatment of single-phase service as being more expensive than three-phase service gets it backward. If load of a single-phase customer or area changed in a manner that required three-phase service, the utility's costs would increase; if anything, classes disproportionately served with single-phase primary should be assigned lower costs than those requiring three-phase service. The classification of primary conductor as load-related will allocate more of the three-phase costs to the classes whose loads require that equipment.

<sup>139</sup> As noted above, some utilities may be able to attribute some upgrades in pole class to line transformers; that increment is appropriately functionalized to secondary service. On the other hand, the secondary classes may be due a small credit to reflect the fact that they allow the use of some less expensive poles.

## 11.2 Distribution Classification

The classification of distribution infrastructure has been one of the most controversial elements of utility cost allocation for more than a half-century.

Bonbright devoted an entire section to a discussion of why none of the methods then commonly used was defensible (1961, pp. 347-368). In any case, traditional methods have divided up distribution costs as either demand-related or customer-related, but newly evolving methods can fairly allocate a substantial portion of these costs on an energy basis.

Distribution equipment can be usefully divided into three groups:

- Shared distribution plant, in which each item serves multiple customers, including substations and almost all spans of primary lines.
- Customer-related distribution plant that serves only one customer, particularly traditional meters used solely for billing.
- A group of equipment that may serve one customer in some cases or many customers in others, including transformers, secondary lines and service drops.

## Newly evolving methods can fairly allocate a substantial portion of distribution costs on an energy basis.

The basic customer method for classification counts only customer-specific plant as customer-related and the entire shared distribution network as demand- or energy-related. For relatively dense service territories, in cities and suburbs, this would be only the traditional meter and a portion of service drop costs.<sup>140</sup> For very thinly settled territories, particularly rural cooperatives, customer-specific plant may include some portion of transformer costs and the percentage of the primary system that consists of line extensions to individual customers. Many jurisdictions have mandated or accepted the basic customer classification approach, sometimes including a portion of transformers in the customer cost. These jurisdictions include Arkansas,<sup>141</sup> California,<sup>142</sup> Colorado,<sup>143</sup> Illinois,<sup>144</sup> Iowa,<sup>145</sup> Massachusetts,<sup>146</sup> Texas<sup>147</sup> and Washington.<sup>148</sup>

The basic customer method for classification is by far the most equitable solution for the vast majority of utilities.

140 Alternatively, all service drops may be treated as customer-related and the sharing of service drops can be reflected in the allocation factor. As discussed in Section 5.2, treating multifamily housing as a separate class facilitates crediting those customers with the savings from shared service drops, among other factors.

141 The Arkansas Public Service Commission found that “accounts 364-368 should be allocated to the customer classes using a 100% demand methodology and ... that [large industrial consumer parties] do not provide sufficient evidence to warrant a determination that these accounts reflect a customer component necessary for allocation purposes” (2013, p. 126).

142 California classifies all lines (accounts 364 through 367) as demand-related for the calculation of marginal costs, while classifying transformers (Account 368) as customer-related with different costs per customer for each customer class, reflecting the demands of the various classes.

143 In 2018, the state utility commission affirmed a decision by an administrative law judge that rejected the **zero-intercept approach** and classified FERC accounts 364 through 368 as 100% demand-related (Colorado Public Utilities Commission, 2018, p. 16).

144 “As it has in the past, ... the [Illinois Commerce] Commission rejects the minimum distribution or zero-intercept approach for purposes of allocating distribution costs between the customer and demand functions in this case. In our view, the coincident peak method is consistent with the fact that distribution systems are designed primarily to serve electric demand. The Commission believes that attempts to separate the costs of connecting customers to the electric distribution system from the

costs of serving their demand remain problematic” (Illinois Commerce Commission, 2008, p. 208).

145 According to 199 Iowa Administrative Code 20.10(2)e, “customer cost component estimates or allocations shall include only costs of the distribution system from and including transformers, meters and associated customer service expenses.” This means that all of accounts 364 through 367 are demand-related. Under this provision, the Iowa Utilities Board classifies the cost of 10 kVA per transformer as customer-related but reduces the cost that is assigned to residential and small commercial customers to reflect the sharing of transformers by multiple customers.

146 “Plant items classified as customer costs included only meters, a portion of services, street lighting plant, and a portion of labor-related general plant” (La Capra, 1992, p. 15). See also Gorman, 2018, pp. 13-15.

147 Texas has explicitly adopted the basic customer approach for the purposes of rate design: “Specifically, the customer charge shall be comprised of costs that vary by customer such as metering, billing and customer service” (Public Utility Commission of Texas, 2000, pp. 5-6). But it has followed this rule in practice for cost allocation as well.

148 “The Commission finds that the Basic Customer method represents a reasonable approach. This method should be used to analyze distribution costs, regardless of the presence or absence of a decoupling mechanism. We agree with Commission Staff that proponents of the Minimum System approach have once again failed to answer criticisms that have led us to reject this approach in the past. We direct the parties not to propose the Minimum System approach in the future unless technological changes in the utility industry emerge, justifying revised proposals” (Washington Utilities and Transportation Commission, 1993, p. 11).

For certain rural utilities, this may be reasonable under the conceptual view that the size of distribution components (e.g., the diameter of conductors or the capacity of transformers) is load-related, but the number and length of some types of equipment is customer-related. In some rural service territories, the basic customer cost may require nearly a mile of distribution line along the public way as essentially an extended service drop.

However, more general attempts by utilities to include a far greater portion of shared distribution system costs as customer-related are frequently unfair and wholly unjustified. These methods include straight fixed/variable approaches where all distribution costs are treated as customer-related (analogous to the misuse of the concept of fixed costs in classifying generation discussed in Section 9.1) and the more nuanced minimum system and zero-intercept approaches included in the 1992 NARUC cost allocation manual.

The minimum system method attempts to calculate the cost (in constant dollars) if the utility's installed units (transformers, poles, feet of conductors, etc.) were each the minimum-sized unit of that type of equipment that would ever be used on the system. The analysis asks: How much would it have cost to install the same number of units (poles, feet of conductors, transformers) but with the size of the units installed limited to the current minimum unit normally installed? This minimum system cost is then designated as customer-related, and the remaining system cost is designated as demand-related. The ratio of the costs of the minimum system to the actual system (in the same year's dollars) produces a percentage of plant that is claimed to be customer-related.

This minimum system analysis does not provide a reliable basis for classifying distribution investment and vastly overstates the portion of distribution that is customer-related. Specifically, it is unrealistic to suppose that the mileage of the shared distribution system and the number of physical units are customer-related and that only the size of the components is demand-related, for at least eight reasons.

1. Much of the cost of a distribution system is required to cover an area and is not sensitive to either load or customer number. The distribution system is built to cover an area because the total load that the utility expects to serve will justify the expansion into that area. Serving many customers in one multifamily building is no more expensive than serving one commercial customer of the same size, other than metering. The shared distribution cost of serving a geographical area for a given load is roughly the same whether that load is from concentrated commercial or dispersed residential customers along a circuit of equivalent length and hence does not vary with customer number.<sup>149</sup> Bonbright found that there is "a very weak correlation between the area (or the mileage) of a distribution system and the number of customers served by the system." He concluded that "the inclusion of the costs of a minimum-sized distribution system among the customer-related costs seems ... clearly indefensible. [Cost analysts are] under impelling pressure to fudge their cost apportionments by using the category of customer costs as a dumping ground" (1961, p. 348).
2. The minimum system approach erroneously assumes that the minimum system would consist of the same number of units (e.g., number of poles, feet of conductors) as the actual system. In reality, load levels help determine the number of units as well as their size. Utilities build an additional feeder along the route of an existing feeder (or even on the same poles); loop a second feeder to the end of an existing line to pick up some load from the existing line; build an additional feeder in parallel with an existing feeder to pick up the load of some of its branches; and upgrade feeders from single-phase to three-phase. As secondary load grows, the utility typically will add transformers, splitting smaller customers among the existing and new transformers.<sup>150</sup> Some other feeder construction is designed to improve reliability (e.g., to interconnect feeders with automatic switching to reduce the number of customers affected by outages and outage duration).

<sup>149</sup> As noted above, for some rural utilities, particularly cooperatives that extend distribution without requiring that the extension be profitable, a portion of the distribution system may effectively be customer-specific.

<sup>150</sup> Adding transformers also reduces the length of the secondary lines from the transformers to the customers, reducing losses, voltage drop or the required gauge of the secondary lines.



3. Load can determine the type of equipment installed as well. When load increases, electric distribution systems are often relocated from overhead to underground (which is more expensive) because the weight of lines required to meet load makes overhead service infeasible. Voltages may also be increased to carry more load, requiring early replacement of some equipment with more expensive equipment (e.g., new transformers, increased insulation, higher poles to accommodate higher voltage or additional circuits). Thus, a portion of the extra costs of moving equipment underground or of newer equipment may be driven in part by load.
4. The “minimum system” would still meet a large portion of the average residential customer’s demand requirements. Using a minimum system approach requires reducing the demand measure for each class or otherwise crediting the classes with many customers for the load-carrying capability of the minimum system (Sterzinger, 1981, pp. 30-32).
5. Minimum system analyses tend to use the current minimum-sized unit typically installed, not the minimum size ever installed or available. The current minimum unit is sized to carry expected demand for a large percentage of customers or situations. As demand has risen over time, so has the minimum size of equipment installed. In fact, utilities usually stop stocking some less expensive small equipment because rising demand results in very rare use of the small equipment and the cost of maintaining stock is no longer warranted.<sup>151</sup> However, the transformer industry could produce truly minimum-sized utility transformers, the size of those used for cellular telephone chargers, if there were a demand for these.
6. Adding customers without adding peak demand or serving new areas does not require any additional poles or conductors. For example, dividing an existing home into two dwelling units increases the customer count but likely adds nothing in utility investment other than a second meter. Converting an office building from one large tenant to a dozen small offices similarly increases customer number without increasing shared distribution costs. And the shared distribution investment on a block with four large customers is essentially the same as for a block with 20 small customers with the same load characteristics. If an additional service is added into an existing street with electrical service, there is usually no need to add poles, and it would not be reasonable to assume any pole savings if the number of customers had been half the actual number.
7. Most utilities limit the investment they will make for low projected sales levels, as we also discuss in Section 15.2, where we address the relationship between the utility line extension policy and the utility cost allocation methodology. The prospect of adding revenues from a few commercial customers may induce the utility to spend much more on extending the distribution system than it would invest for dozens of residential customers.
8. Not all of the distribution system is embedded in rates, since some customers pay for the extension of the system with **contributions in aid of construction**, as discussed in Section 15.2. Factoring in the entire length of the system, including the part paid for with these contributions, overstates the customer component of ratepayer-funded lines. Thus, the frequent assumption that the number of feet of conductors and the number of secondary service lines is related to customer number is unrealistic. A piece of equipment (e.g., conductor, pole, service drop or meter) should be considered customer-related only if the removal of one customer eliminates the need for the unit. The number of meters and, in most cases, service drops is customer-related, while feet of conductors and number of poles are almost entirely load-related. Reducing the number of customers, without reducing area load, will only rarely affect the length of lines or the number of poles or transformers. For example, removing one customer will avoid

---

<sup>151</sup> For example, in many cases, utilities that make an allocation based on a minimum system use 10-kVA transformers, even though they installed 3-kVA or 5-kVA transformers in the past. Some utilities also have used conductor sizes and costs significantly higher than the actual minimum conductor size and cost on their systems.

overhead distribution equipment only under several unusual circumstances.<sup>152</sup> These circumstances represent a very small part of the shared distribution cost for the typical urban or suburban utility, particularly since many of the most remote customers for these utilities might be charged a contribution in aid of construction. These circumstances may be more prevalent for rural utilities, principally cooperatives.

The related zero-intercept method attempts to extrapolate from the cost of actual equipment (including actual minimum-sized equipment) to the cost of hypothetical equipment that carries zero load. The zero-intercept method usually involves statistical regression analysis to decompose the costs of distribution equipment into customer-related costs and costs that vary with load or size of the equipment, although some utilities use labor installation costs with no equipment. The idea is that this procedure identifies the amount of equipment required to connect existing customers that is not load-related (a zero-kVA transformer, a zero-ampere conductor or a pole that is zero feet high). The zero-intercept regression analysis is so abstract that it can produce a wide range of results, which vary depending on arcane statistical methods and the choice of types of equipment to include or exclude from an equation. As a result, the zero-intercept method is even less realistic than the minimum system method.

The best practice is to determine customer-related costs using the basic customer method, then use more advanced techniques to split the remainder of shared distribution system costs as energy-related and demand-related. Energy use, especially in high-load hours and in off-peak hours on high-load days, affects distribution investment and outage costs in the following ways:

- The fundamental reason for building distribution systems is to deliver energy to customers, not simply to connect them to the grid.
- The number and extent of overloads determines the life of the insulation on lines and in transformers (in both

substations and line transformers) and hence the life of the equipment. A transformer that is very heavily loaded for a couple of hours a year and lightly loaded in other hours may last 40 years or more until the enclosure rusts away. A similar transformer subjected to the same annual peaks, but also to many smaller overloads in each year, may burn out in 20 years.

- All energy in high-load hours, and even all hours on high-load days, adds to heat buildup and results in sagging overhead lines, which often defines the thermal limit on lines; aging of insulation in underground lines and transformers; and a reduction the ability of lines and transformers to survive brief load spikes on the same day.
- Line losses depend on load in every hour (marginal line losses due to another kWh of load greatly exceed the average loss percentage in that hour, and losses at peak loads dramatically exceed average losses).<sup>153</sup> To the extent that a utility converts a distribution line from single-phase to three-phase, selects a larger conductor or increases primary voltage to reduce losses, the costs are primarily energy-related.
- Customers with a remote need for power only a few hours per year, such as construction sites or temporary businesses like Christmas tree lots, will often find non-utility solutions to be more economical. But when those same types of loads are located along existing distribution lines, they typically connect to utility service if the utility's **connection charges** are reasonable.

A portion of distribution costs can thus be classified to energy, or the demand allocation factor can be modified to reflect energy effects.

The average-and-peak method, discussed in Section 9.1 in the context of generation classification, is commonly used by natural gas utilities to classify distribution mains and other shared distribution plant.<sup>154</sup> This approach recognizes that a portion of shared distribution would be needed even if all

152 These circumstances are: (1) if the customer would have been the farthest one from the transformer along a span of secondary conductor that is not a service drop; (2) if the customer is the only one served off the last pole at the end of a radial primary feeder, a pole and a span of secondary, or a span of primary and a transformer; and (3) if several poles are required solely for that customer.

153 For a detailed analysis of the measurement and valuation of marginal line losses, see Lazar and Baldwin (2011).

154 See *Gas Distribution Rate Design Manual* from the National Association of Regulatory Utility Commissioners (1989, pp. 27-28) as well as more recent orders from the Minnesota Public Utilities Commission describing the range of states that use basic customer and average-and-peak methods for natural gas cost allocation (2016, pp. 53-54) and the Michigan Public Service Commission affirming the usage of the average-and-peak method (2017, pp. 113-114).

customers used power at a 100% load factor, while other costs are incurred to upsize the system to meet local peak demands. The same approach may have a place in electric distribution system classification and allocation, with something over half the basic infrastructure (poles, conductors, conduit and transformers) classified to energy to reflect the importance of energy use in justifying system coverage and the remainder to demand to reflect the higher cost of sizing equipment to serve a load that isn't uniform.

Nearly every electric utility has a line extension policy that dictates the circumstances under which the utility or a new customer must pay for an extension of service. Most of these provide only a very small investment by the utility in shared facilities such as circuits, if expected customer usage is very small, but much larger utility investment for large added load. Various utilities compute the allowance for line extensions in different ways, which are usually a variant of one of the following approaches:

- The credit equals a multiple of revenue. For example, Otter Tail Power Co. in Minnesota will invest up to three times the expected annual revenue, with the customer bearing any excess (Otter Tail Power Co., 2017, Section 5.04). Xcel Energy's Minnesota subsidiary uses 3.5 times expected annual revenue for nonresidential customers (Northern States Power Co.-Minnesota, 2010, Sheet 6-23). Other utilities base their credits on expected nonfuel revenue or the distribution portion of the tariff; on different periods of revenue; and on either simple total revenue or present value of revenue.<sup>155</sup> These are clearly usage-related allowances that, in turn, determine how much cost for distribution circuits is reflected in the utility revenue requirement. Applying this logic, all shared distribution plant should thus be classified as usage-related, and none of the shared distribution system should be customer-related.
- The credit is the actual extension cost, capped at a fixed value. For example, Minnesota Power pays up to \$850 for the cost of extending lines, charges \$12 per foot for

costs over \$850 and charges actual costs for extensions over 1,000 feet (Minnesota Power, 2013, p. 6). Xcel Energy's Colorado subsidiary gives on-site construction allowances of \$1,659 for residential customers, \$2,486 for small commercial, \$735 per kW for other secondary nonresidential and \$680 per kW for primary customers (Public Service Company of Colorado, 2018, Sheet R226). The company describes these allowances as "based on two and three-quarters (2.75) times estimated annual non-fuel revenue" — a simplified version of the revenue approach.<sup>156</sup>

- The credit is determined by distance. Xcel Energy's Minnesota subsidiary includes the first 100 feet of line extension for a residential customer into rate base, with the customer bearing the cost for any excess length (Northern States Power Co.-Minnesota, 2010, Sheet 6-23). Green Mountain Power applies a credit equal to the cost of 100 feet of overhead service drop but no costs for poles or other equipment (Green Mountain Power, 2016, Sheet 148). The portion of the line extensions paid by the utility might be thought of as customer-related, with some caveats. First, the amount of the distribution system that was built out under this provision is almost certainly much less than 100 feet times the number of residential customers. Second, these allowances are often determined as a function of expected revenue, as in the Xcel Colorado example, and thus are usage-related. If the line extension investment is tied to revenue (and most revenue is associated with usage-related costs, such as fuel, purchased power, generation, transmission and substations), then the resulting investment should be classified and allocated on a usage basis. The cost of service study should ensure that the costs customers prepay are netted out (including not just the costs but the footage of lines or excess costs of poles and transformers if a minimum system method is used) before classifying any distribution costs as customer-related.

155 California sets electric line extension allowances at expected net distribution revenue divided by a cost of service factor of roughly 16% (California Public Utilities Commission, 2007, pp. 8-9).

156 The company also has the option of applying the 2.75 multiple directly (Public Service Company of Colorado, 2018, Sheet R212).

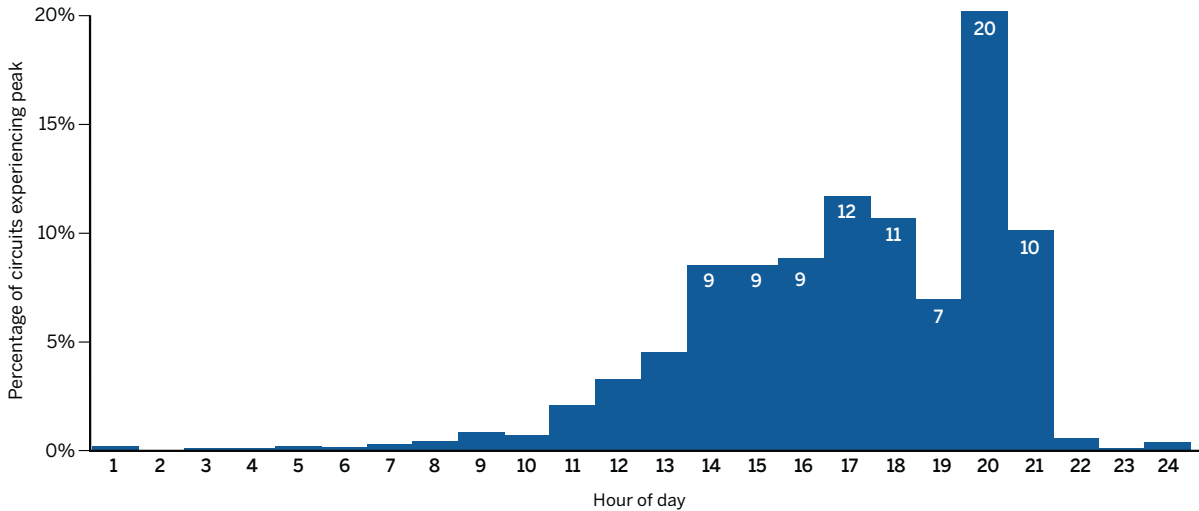
**Figure 40. San Diego Gas & Electric circuit peaks**

Source: Fang, C. (2017, January 20). Direct testimony on behalf of San Diego Gas & Electric. California Public Utilities Commission Application No. 17-01-020

## 11.3 Distribution Demand Allocators

In any traditional study, a significant portion of distribution plant is classified as demand-related. A newer hourly allocation method may omit this step, assigning distribution costs to all hours when the asset (or a portion of the cost of the asset) is required for service.

For demand-related costs, class NCP is commonly, but often inappropriately, used for allocation. This allocator would be appropriate if each component overwhelmingly served a single class, if the equipment peaks occurred roughly at the time of the class peak, and if the sizing of distribution equipment were due solely to load in a single hour. But to the contrary, most substations and many feeders serve several tariffs, in different classes, and many tariff codes.<sup>157</sup>

### 11.3.1 Primary Distribution Allocators

Customers in a single class, in different areas and served by different substations and feeders, may experience peak loads at different times. Figure 40 shows the hours when each of San Diego Gas & Electric's distribution circuits experienced peak loads (Fang, 2017, p. 21). The peaks are clustered between

the early afternoon (on circuits that are mostly commercial) and the early evening (mostly residential), while other circuits experience their peaks at a wide variety of hours.

Figure 41 on the next page shows the distribution of substation peaks for Delmarva Power & Light over a period of one year (Delmarva Power & Light, 2016). The area of each bubble is proportional to the peak load on the station. Clearly, no one peak hour (or even a combination of monthly peaks) is representative of the class contribution to substation peaks.

The peaks for substations, lines and other distribution equipment do not necessarily align with the class NCPs. Indeed, even if all the major classes are summer peaking, some of the substations and feeders may be winter peaking, and vice versa. Even within a season, substation and feeder peaks will be distributed to many hours and days.

Although load levels drive distribution costs, the maximum load on each piece of equipment is not the only important load. As explained in Subsection 5.1.3, increased

<sup>157</sup> Some utilities design their substations so that each feeder is fed by a single transformer, rather than all the feeders being served by all the transformers at the substation. In those cases, the relevant loads (for timing and class mix) are at the transformer level, rather than the entire substation.

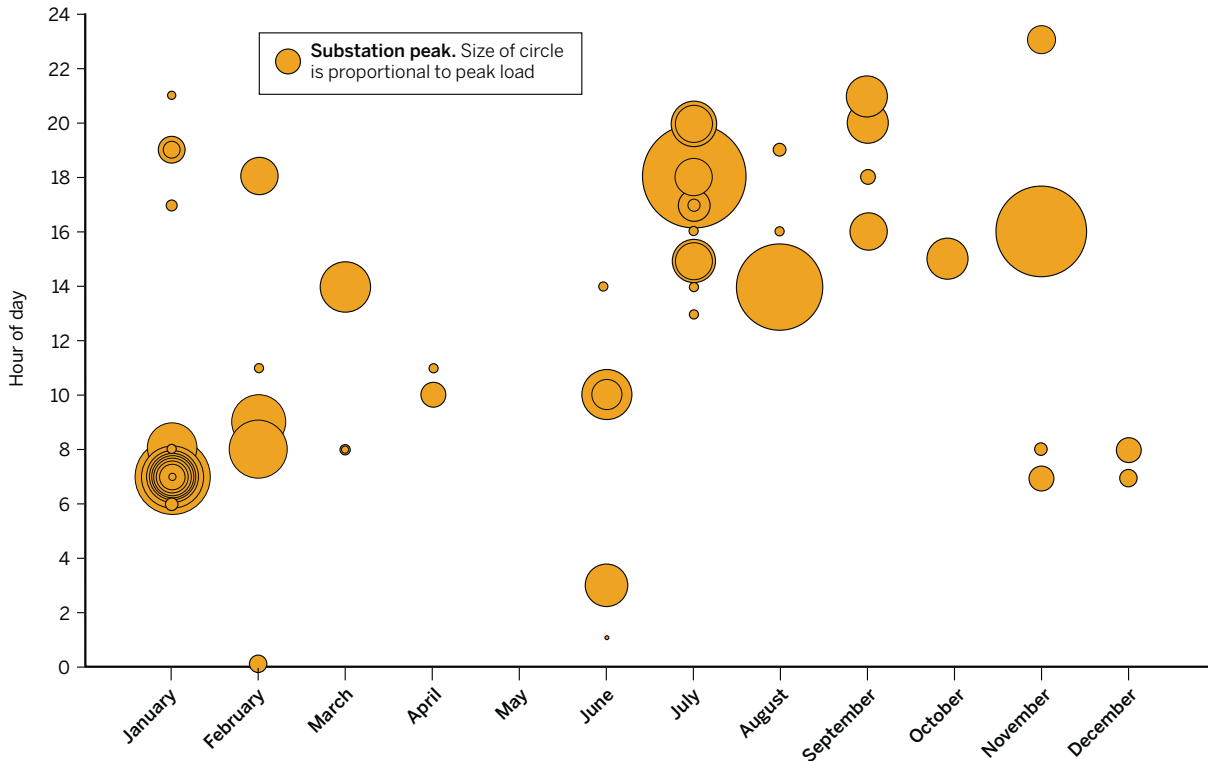
**Figure 41. Month and hour of Delmarva Power & Light substation peaks in 2014**

Source: Delmarva Power & Light. (2016, August 15). Response to the Office of the People's Counsel data request 5-11, Attachment D. Maryland Public Service Commission Case No. 9424

energy use, especially at high-load hours and prior to those hours, can also affect the sizing and service life of transformers and underground lines, which is thus driven by the energy use on the equipment in high-load periods, not just the maximum demand hour. The peak hourly capacity of a line or transformer depends on how hot the equipment is prior to the peak load, which depends in turn on the load factor in the days leading up to the peak and how many high-load hours occur prior to the peak. More frequent events of load approaching the equipment capacity, longer peaks and hotter equipment going into the peak period all contribute to faster insulation deterioration and cumulative line sag, increasing the probability of failure and accelerating aging.

Ideally, the allocators for each distribution plant type should reflect the contribution of each class to the hours when load on the substation, feeder or transformer

contributes to the potential for overloads. That allocation could be constructed by assigning costs to hours or by constructing a special demand allocator for each category of distribution equipment. If a detailed allocation is too complex, the allocators for costs should still reflect the underlying reality that distribution costs are driven by load in many hours.

The resulting allocator should reflect the variety of seasons and times at which the load on this type of equipment experiences peaks. In addition, the allocator should reflect the near-peak and prepeak loads that contribute to overheating and aging of equipment. Selecting the important hours for distribution loads and the weight to be given to the prepeak loads may require some judgments. Class NCP allocators do not serve this function.

Rocky Mountain Power allocates primary distribution

on monthly coincident distribution peak, weighted by the percentage of substations peaking in each month (Steward, 2014, p. 7). Under this weighting scheme, for example:

- A small substation has as much effect on a month's weighting factor as a large substation. The month with the largest number of large substations seriously overloaded could be the highest-cost month yet may not receive the highest weight since each substation is weighted equally.
- The month's contribution to distribution demand costs is assumed to occur entirely at the hour of the monthly distribution peak, even though most of the substation capacity that peaks in the month may have peaked in a variety of different hours.
- A month would receive a weight of 100% whether each substation's maximum load was only 1 kVA more than its maximum in every other month or four times its maximum in every other month.

This approach could be improved by reflecting the capacity of the substations, the actual timing of the peak hours and the number of near-peak hours of each substation in each month. The hourly loads might be weighted by the square or some other power of load or by using a peak capacity allocation factor for the substation, to reflect the fact that the contribution to line losses and equipment life falls rapidly as load falls below peak.

Many utilities will need to develop additional information on system loads for cost allocation, as well as for planning, operational and rate design purposes. Specifically, utilities should aim to understand when each feeder and substation reaches its maximum loads and the mix of rate classes on each feeder and distribution substation.

In the absence of detailed data on the loads on line transformers, feeders and substations, utilities will be limited to cruder aggregate load data. For primary equipment, the best available proxy may be the class energy usage in the expected

high-load period for the equipment, the class contribution to coincident peak or possibly class NCP, but only if that NCP is computed with respect to the peak load of the customers sharing the equipment. Although most substations and feeders serving industrial and commercial customers will also serve some residential customers, and most residential substations and feeders will have some commercial load, some percentage of distribution facilities serve a single class.

The NCP approximation is not a reasonable approximation for finer disaggregation of class loads. For example, there are many residential areas that contain a mix of single-family and multifamily housing and homes with and without electric space heating, electric water heating and solar panels. The primary distribution plant in those areas must be sized for the combined load in coincident peak periods, which may be the late afternoon summer cooling peak, the evening winter heating and lighting peak or some other time — but it will be the same time for all the customers in the area.<sup>158</sup>

Many utilities have multiple tariffs or tariff codes for residential customers (e.g., heating, water heating, all-electric and solar; single-family, multifamily and public housing; low-income and standard), for commercial customers (small, medium and large; primary and secondary voltage; schools, dormitories, churches and other customer types) and for various types of industrial customers, in addition to street lighting and other services. In most cases, those subclasses will be mixed together, resulting in customers with gas and electric space heat, gas and electric water heat, and with and without solar in the same block, along with street lights. The substation and feeder will be sized for the combined load, not for the combined peak load of just the electric heat customers or the combined peak of the customers with solar panels<sup>159</sup> or the street lighting peak.

Unless there is strong geographical differentiation of the subclasses, any NCP allocator should be computed for the

158 Distribution conductors and transformers have greater capacity in winter (when heat is removed quickly) than in summer; even if winter peak loads are higher, the sizing of some facilities may be driven by summer loads.

159 The division of the residential class into subclasses for calculation of the class NCP has been an issue in several recent Texas cases. In Docket No. 43695, at the recommendation of the Office of Public Utility Counsel, the Public Utility Commission of Texas reversed its former method for Southwestern Public Service to use the NCP for a single residential

class (instead of separate subclasses for residential customers with and without electric heat), which reduced the costs allocated to residential customers as a whole (Public Utility Commission of Texas, 2015, pp. 12-13 and findings of fact 277A, 277B and 339A). The issue was also raised in dockets 44941 and 46831 involving El Paso Electric Co. El Paso Electric proposed separate NCP allocations for residential customers with and without solar generation, which the Office of Public Utility Counsel and solar generator representatives opposed. Both of these cases were settled and did not create a precedent.

combined load of the customer classes, with the customer class NCP assigned to rate tariffs in proportion to their estimated contribution to the customer class peak.

### 11.3.2 Relationship Between Line Losses and Conductor Capacity

In some situations, conductor size is determined by the economics of line losses rather than by thermal overloads or voltage drop. Even at load levels that do not threaten reliability, larger conductors may cost-effectively reduce line losses, especially in new construction.<sup>160</sup> The incremental cost of larger capacity can be entirely justified by loss reduction (which is mostly an energy-related benefit), with higher load-carrying capability as a free additional benefit.

### 11.3.3 Secondary Distribution Allocators

Each piece of secondary distribution equipment generally serves a smaller number of customers than a single piece of primary distribution equipment. On a radial system, a line transformer may serve a single customer (a large commercial customer or an isolated rural residence) or 100 apartments; a secondary line may serve a few customers or a dozen, depending on the density of load and construction. Older urban neighborhoods often have secondary lines that are connected to several transformers, and some older large cities such as Baltimore have full secondary networks in city centers.<sup>161</sup> In contrast, a primary distribution feeder may serve thousands of customers, and a substation can serve several feeders.

Thus, loads on secondary equipment are less diversified than loads on primary equipment. Hence, cost of service studies frequently allocate secondary equipment on load measures that reflect customer loads diversified for the number of customers on each component. Utilities often use assumed diversity factors to determine the capacity required

for secondary lines and transformers, for various numbers of customers. Figure 42 on the next page provides an example of the diversity curve from El Paso Electric Co. (2015, p. 24).

Even identical houses with identical equipment may routinely peak at different times, depending on household composition, work and school schedules and building orientation. The actual peak load for any particular house may occur not at typical peak conditions but because of events not correlated with loads in other houses. For example, one house may experience its maximum load when the family returns from vacation to a hot house in the summer or a very cold one in the winter, even if neither temperatures nor time of day would otherwise be consistent with an annual maximum load. The house next door may experience its maximum load after a water leak or interior painting, when the windows are open and fans, dehumidifiers and the heating or cooling system are all in use.

Accounting for diversity among different types of residential customers, the load coincidence factors would be even lower. A single transformer may serve some homes with electric heat, peaking in the winter, and some with fossil fuel heat, peaking in the summer.

The average transformer serving residential customers may serve a dozen customers, depending on the density of the service territory and the average customer NCP, which for the example in Figure 42 suggests that the customers' average contribution to the transformer peak load would be about 40% of the customers' undiversified load. Thus, the residential allocator for transformer demand would be the class NCP times 40%. Larger commercial customers generally have very little diversity at the transformer level, since each transformer (or bank of transformers) typically serves only one or a few customers.

The same factors (household composition, work and

160 The same is true for increased distribution voltage. Seattle City Light upgraded its residential distribution system from 4 kV to 26 kV in the early 1980s based on analysis done in the Energy 1990 study, prepared in 1976, which focused on avoiding new baseload generation. The line losses justified the expenditure, but the result was also a dramatic increase in distribution system circuit capacity. The Energy 1990 study was discussed in detail in a meeting of the City Council Utilities Committee (Seattle Municipal Archives, 1977).

161 In high-load areas, such as city centers, utilities often operate secondary distribution networks, in which multiple primary feeders serve multiple transformers, which then feed a network of interconnected secondary

lines that feed all the customers on the network (See Behnke et al., 2005, p. 11, Figure 8). In secondary networks, the number of transformers and the investment in secondary lines are driven by the aggregate load of the entire network or large parts of the network. The loss of any one feeder and one transformer, or any one run of secondary line, will not disconnect any customer. The existence of the network, the number of transformers and the number and length of primary and secondary lines are entirely load-related. Similar arrangements, called spot networks, are used to serve individual large customers with high reliability requirements. A single spot network customer may thus have multiple transformers, providing redundant capacity.

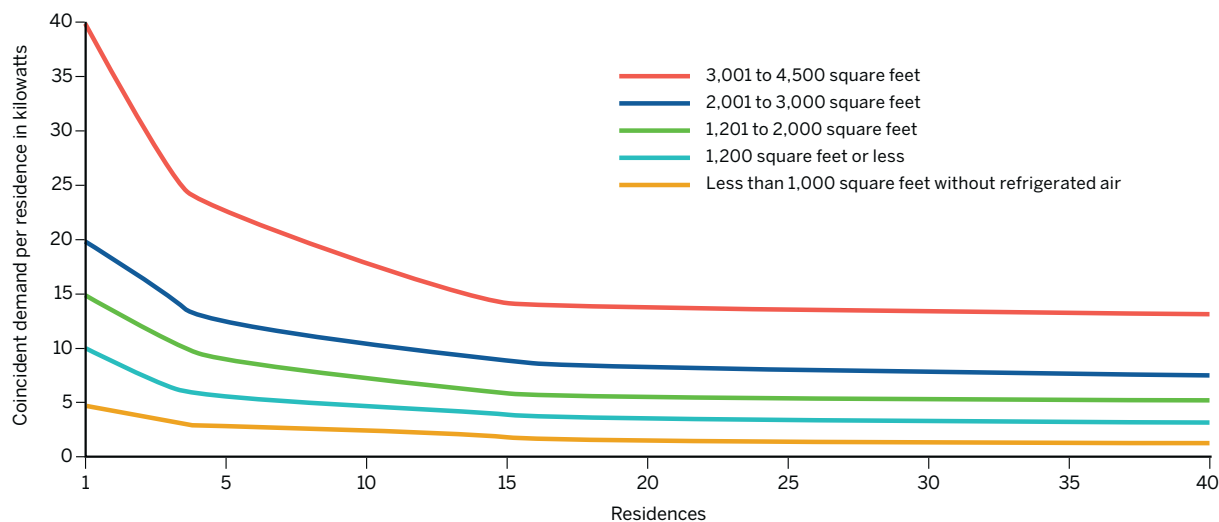
**Figure 42. Typical utility estimates of diversity in residential loads**

Source: El Paso Electric Co. (2015, October 29). *El Paso Electric Company's Response to Office of Public Utility Counsel's Fifth Request for Information*. Public Utility Commission of Texas Docket No. 44941

school schedules, unit-specific events) apply in multifamily housing as well as in single-family housing. But the effects of orientation are probably even stronger in multifamily housing than in single-family homes. For example, units on the east side of a building are likely to have summer peak loads in the morning, while those on the west side are likely to experience maximum loads in the evening and those on the south in the middle of the day.

Importantly, Figure 42 represents the diversity of similar neighboring single-family houses. Diversity is likely to be still higher for other applications, such as different types and vintages of neighboring homes, or the great variety of customers who may be served from the shared transformers and lines of a secondary network.

Until 2001, the major U.S. electric utilities were required to provide the number and capacity of transformers in service on their FERC Form 1 reports. Assuming an average of one transformer per commercial and industrial customer, these reports typically suggest a ratio ranging from 3 to more than 20 residential customers per transformer, with the lower ratios for the most rural IOUs and the highest for utilities with dense urban service territories and many multifamily consumers.<sup>162</sup> Only about a dozen electric co-ops filed a FERC Form 1 with the transformer data in 2001, and their

ratios vary from about 1 transformer per residential customer for a few very rural co-ops to about 8 residential customers per transformer for Chugach Electric, which serves part of Anchorage as well as rural areas.

Utilities can often provide detailed current data from their geographic information systems. Table 30 on the next page shows Puget Sound Energy's summary of the number of transformers serving a single residential customer and the number serving multiple customers (Levin, 2017, pp. 8-9). More than 95% of customers are served by shared transformers, and those transformers serve an average of 5.3 customers. Using the method described in the previous paragraph, an estimated average of 4.9 Puget Sound Energy residential customers would share a transformer, which is close to the actual average of 4.5 customers per transformer shown in Table 30 (Levin, 2017, and additional calculations by the authors).

The customers who have their own transformer may be too far from their neighbors to share a transformer, or local load growth may have required that the utility add a transformer. In many cases, residential customers with

<sup>162</sup> Ratios computed using Form 1, p. 429, transformer data (Federal Energy Regulatory Commission, n.d.) and 2001 numbers from utilities' federal Form 861 (U.S. Energy Information Administration, n.d.-a, file 2).



**Table 30. Residential shared transformer example**

	With multiple residences per transformer	With single residence per transformer	Total
<b>Number of transformers</b>	197,503	47,699	245,202
<b>Number of customers</b>	1,054,296	47,699	1,101,995
<b>Customers per transformer</b>	5.3	1	4.5

Sources: Levin, A. (2017, June 30). Prefiled response testimony on behalf of NW Energy Coalition, Renewable Northwest and Natural Resources Defense Council. Washington Utilities and Transportation Commission Docket No. UE-170033; additional calculations by the authors

individual transformers may need to pay to obtain service that is more expensive than their line extension allowances (see Section 11.2 or Section 15.2).

Small customers will have similar, but lower, diversity on secondary conductors, which generally serve multiple customers but not as many as a transformer. A transformer that serves a dozen customers may serve two of them directly without secondary lines, four customers from one stretch of secondary line and six from another stretch of secondary line running in the opposite direction or across the street.

Where no detailed data are available on the number of customers per transformer in each class, a reasonable approximation might be to allocate transformer demand costs on a simple average of class NCP and customer NCP for residential and small commercial customers and just customer NCP for larger nonresidential customers.

### 11.3.4 Distribution Operations and Maintenance Allocators

Distribution O&M accounts associated with a single type of equipment (FERC accounts 582, 591 and 592 for substations

and Account 595 for transformers) should be classified and allocated in the same manner as associated equipment. Other accounts serve both primary and secondary lines and service drops (accounts 583, 584, 593 and 594) or include services to a range of equipment (accounts 580 and 590). These costs normally should be classified and allocated in proportion to the plant in service, for the plant accounts they support, subfunctionalized as appropriate. For example, typical utility tree-trimming activities are almost entirely related to primary overhead lines, with very little cost driven by secondary distribution and no costs for protecting service lines (see, for example, Entergy Corp., n.d.).

### 11.3.5 Multifamily Housing and Distribution Allocation

One common error in distribution cost allocation is treating the residential class as if all customers were in single-family structures, with one service drop per customer and a relatively small number of customers on each transformer.<sup>163</sup> For multifamily customers, one or a few transformers may serve 100 or more customers through a single service line.<sup>164</sup> Treating multifamily customers as if they were single-family customers would overstate their contribution to distribution costs, particularly line transformers and secondary service lines.<sup>165</sup>

This problem can be resolved in either of two ways. The broadest solution is to separate residential customers into two allocation classes: single-family residential and multifamily residential, as we discuss in Section 5.2.<sup>166</sup> Alternatively, the allocation of transformer and service costs to a combined residential class (as well as residential rate design) should take into account the percentage of customers who are in multifamily buildings, and only components that are not shared should be considered customer-related.

163 One large service drop is much less expensive than the multiple drops needed to serve the same number of customers in single-customer buildings. Small commercial customers may also share service drops, although probably to a more limited extent than residential customers.

164 Similarly, if the cost of service study includes any classification of shared distribution plant as customer-related (such as from a minimum system), each multifamily building should be treated as a single location, rather than a large number of dispersed customers. For utilities without remote meter reading, the labor cost for that activity per multifamily customer will be lower than for single-family customers.

165 Allocating transformer costs on demand eliminates the bias for that cost category.

166 If any sort of NCP allocator is used in the cost of service study, the multifamily class load generally should be combined with the load of the type of customers that tend to surround the multifamily buildings in the particular service territory, which may be single-family residential or medium commercial customers.

### 11.3.6 Direct Assignment of Distribution Plant

Direct cost assignment may be appropriate for equipment required for particular customers, not shared with other classes, and not double-counted in class allocation of common costs. Examples include distribution-style poles that support streetlights and are not used by any other class; the same may be true for spans of conductor to those poles. Short tap lines from a main primary voltage line to serve a single primary voltage customer's premises may be another example, as they are analogous to a secondary distribution service drop.

Beyond some limited situations, it is not practical or useful to determine which distribution equipment (such as lines and poles) was built for only one class or currently serves only one class and to ensure that the class is properly credited for not using the other distribution equipment jointly used by other classes in those locations.

## 11.4 Allocation Factors for Service Drops

The cost of a service drop clearly varies with a number of factors that vary by class: customer load (which affects the capacity of the service line), the distance from the distribution line to the customer, underground versus overhead service, the number of customers sharing a service (or the number of services required by a single customer) and whether customers require three-phase service.

Some utilities, including Baltimore Gas & Electric, attempt to track service line costs by class over time (Chernick, 2010, p. 7). This approach is ideal but complicated. Although assigning the costs of new and replacement service lines just requires careful cost accounting, determining the costs of services that are retired and tracking changes in the class or classes in a building (which may change over time from manufacturing to office space to mixed residential and retail) is much more complex. Other utilities allocate service lines on the sum of customer maximum demands in each class. This has the advantage of reflecting the fact that larger customers require larger (and often longer) service lines, without requiring a detailed

analysis of the specific lines in use for each class.

Many utilities have performed bottom-up analyses, selecting a typical customer or an arguably representative sample of customers in each class, pricing out those customers' service lines and extrapolating to the class. Since the costs are estimated in today's dollars, the result of these studies is the ratio of each class's cost of services to the total cost, or a set of weights for service costs per customer. Either approach should reflect the sharing of services in multifamily buildings.

## 11.5 Classification and Allocation for Advanced Metering and Smart Grid Costs

Traditional meters are often discussed as part of the distribution system but are primarily used for billing purposes.<sup>167</sup> These meters typically record energy and, for some classes, customer NCP demand for periodic manual or remote reading and generally are classified as customer-related. Meter costs are then typically allocated on a basis that reflects the higher costs of meters for customers who take power at higher voltage or three phases, for demand-recording meters, for TOU meters and for hourly-recording energy meters. The weights may be developed from the current costs of installing the various types of meters, but as technology changes, those costs may not be representative of the costs of equipment in rates.

In many parts of the country, this traditional metering has been replaced with advanced metering infrastructure. AMI investments were funded in many cases by the American Recovery and Reinvestment Act of 2009, the economic stimulus passed during the Great Recession, but in other cases ratepayers are paying for them in full in the traditional method. In many jurisdictions, AMI has been accompanied by other complementary "smart grid"

---

<sup>167</sup> Some customers who are small or have extremely consistent load patterns are not metered; instead, their bills are estimated based on known load parameters. The largest group of these customers is street lighting customers, but some utilities allow unmetered loads for various small loads that can be easily estimated or nearly flat loads with very high load factors (such as traffic signals). An example of an unmetered customer from the past was a phone booth. Unmetered customers should not be allocated costs of traditional metering and meter reading.

**Table 31. Smart grid cost classification**

Smart grid element	Legacy approach			Smart grid classification
	Equivalent cost	FERC account	Classification	
<b>Smart meters</b>	Meters	370	Customer	Demand, energy and customer
<b>Distribution control devices</b>	Station equipment and devices	362, 365, 367	Demand	Demand and energy
<b>Data collection system</b>	Meter readers	902	Customer	Demand, energy and customer
<b>Meter data management system</b>	Customer accounting and general plant	903, 905, 391	Customer and overhead	Demand, energy and customer

investments. On the whole, these investments include:

- Smart meters, which are usually defined to include the ability to record and remotely report granular load data, measure voltage and power factor, and allow for remote connection and disconnection of the customer.
- Distribution system improvements, such as equipment to remotely monitor power flow on feeders and substations, open and close switches and breakers and otherwise control the distribution system.
- Voltage control equipment on substations to allow modulation of input voltage in response to measured voltage at the end of each feeder.
- Power factor control equipment to respond to signals from the meters.
- Data collection networks for the meters and line monitors.
- Advanced data processing hardware and software to handle the additional flood of data.
- Supporting overhead costs to make the new system work.

The potential benefits of the smart grid, depending on how it is designed and used, include reduced costs for generation, transmission, distribution and customer service, as described in Subsection 7.1.1. A smart meter is much more than a device to measure customer usage to assure an accurate bill — it is the foundation of a system that may provide some or all of the following:

- Benefits at every level of system capacity, by enabling peak load management since the communication system can be used to control compatible end uses, and because customer response to calls for load reduction can be measured and rewarded.

- Distribution line loss savings from improved power factor and phase balancing.
- Reduced energy costs due to load shifting.
- Reliability benefits, saving time and money on service restoration after outages, since the utility can determine which meters do not have power and can determine whether a customer's loss of service is due to a problem inside the premises or on the distribution system.
- Allowing utilities to determine maximum loads on individual transformers.
- Retail service benefits, by reducing meter reading costs compared with manual meter reads and even automated meter reading and by reducing the cost of disconnecting and reconnecting customers.<sup>168</sup>

The installations have also been very expensive, running into the hundreds of millions of dollars for some utilities, and the cost-effectiveness of the AMI projects has been a matter of dispute in many jurisdictions. Since these new systems are much more expensive than the older metering systems and are largely justified by services other than billing, their costs must be allocated over a wider range of activities, either by functionalizing part of the costs to generation, distribution and so on or reflecting those functions in classification or the allocation factor.

Special attention must be given to matching costs and benefits associated with smart grid deployment. The expected benefits spread across the entire spectrum of utility costs, from lower labor costs for meter reading to lower energy

<sup>168</sup> The data systems can also be configured to provide systemwide Wi-Fi internet access, although they usually are not. See Burbank Water and Power (n.d.).

**Table 32. Summary of distribution allocation approaches**

Element	Method	Comments	Hourly allocation
<b>Substations</b>	FUNCTIONALIZATION: Entirely primary CLASSIFICATION: Demand and energy ALLOCATOR: Loads on substations in hours at or near peaks	Reflect effect of energy near peak and preceding peak on sizing and aging	Allocate by substation cost or capacity, then to hours that stress that substation with peak and heating
<b>Poles</b>	FUNCTIONALIZATION: Entirely primary CLASSIFICATION: Demand and energy* ENERGY ALLOCATOR: Energy or revenue DEMAND ALLOCATOR: Loads in hours at or near peaks	Pole costs driven by revenue expectation	As primary lines
<b>Primary conductors</b>	FUNCTIONALIZATION: Entirely primary CLASSIFICATION: Demand and energy* ENERGY ALLOCATOR: Energy or revenue DEMAND ALLOCATOR: Loads in hours at or near peaks	<ul style="list-style-type: none"> <li>• Distribution network is installed due to revenue potential</li> <li>• Sizing determined by loads in and near peak hours</li> </ul>	<ul style="list-style-type: none"> <li>• Cost associated with revenue-driven line extension to all hours</li> <li>• Cost associated with peak loads and overloads on distribution of line peaks and high-load hours</li> </ul>
<b>Line transformers</b>	FUNCTIONALIZATION: Entirely secondary CLASSIFICATION: Demand and energy* ENERGY ALLOCATOR: Secondary energy DEMAND ALLOCATOR: Diversified secondary loads in peak and near-peak hours	Reflect diversity	Distribution of transformer peaks and high-load hours
<b>Secondary conductors</b>	FUNCTIONALIZATION: Entirely secondary CLASSIFICATION: Demand and energy* ENERGY ALLOCATOR: Energy or revenue DEMAND ALLOCATOR: Loads in hours at or near peaks	Energy is more important for underground than overhead	Distribution of line peaks and high-load hours
<b>Meters</b>	FUNCTIONALIZATION: Advanced metering infrastructure to generation, transmission and distribution, as well as metering ALLOCATOR FOR CUSTOMER-RELATED COSTS: Weighted customer	Allocation of generation, transmission and distribution components depends on use of advanced metering infrastructure	N/A

\* Except some to customer, where a significant portion of plant serves only one customer

costs due to load shifting and line loss reduction. Legacy methods for allocating metering costs as primarily customer-related would place the vast majority of these costs onto the residential rate class, but many of the benefits are typically shared across all rate classes. In other words, the legacy method would give commercial and industrial rate classes substantial benefits but none of the costs.

Table 31 identifies some of the key elements of smart grid cost and how these would be appropriately treated in an embedded cost of service study. These approaches match smart grid cost savings to the enabling expenditures.

## 11.6 Summary of Distribution Classification and Allocation Methods and Illustrative Examples

The preceding discussion identifies a variety of methods used to functionalize, classify and allocate distribution plant. Table 32 summarizes the application of some of those methods, including the hourly allocations that may be applicable for modern distribution systems with:

- A mix of centralized and distributed resources, conventional and renewable, as well as storage.
- The ability to measure hourly usage on the substations and feeders.
- The ability to estimate hourly load patterns on transformers and secondary lines.

**Table 33. Illustrative allocation of distribution substation costs by different methods**

	Residential	Secondary commercial	Primary industrial	Street lighting	Total
<b>Class NCP: substation (legacy)</b>	\$9,730,000	\$9,730,000	\$7,297,000	\$3,243,000	\$30,000,000
<b>Average and peak</b>	\$10,056,000	\$10,056,000	\$8,100,000	\$1,788,000	\$30,000,000
<b>Hourly</b>	\$9,939,000	\$10,533,000	\$9,009,000	\$519,000	\$30,000,000

Note: Numbers may not add up to total because of rounding.

Where the available data or analytical resources will not support more sophisticated analyses of distribution cost causation, the following simple rules of thumb may be helpful.

- The only costs that should be classified as customer-related are those specific to individual customers:
  - Basic metering costs, not including the additional costs of advanced meters incurred for system benefits.
  - Service lines, adjusting for shared services in buildings with multiple tenants.
  - For very rural systems, where most transformers and large stretches of primary line serve only a single customer (and those costs are not recovered from contributions in aid of construction), a portion of transformer and primary costs.
- Other costs should be classified as a mix of energy and demand, such as using the average-and-peak allocator.
- The peak demand allocation factor should reflect the distribution of hours in which various portions of distribution system equipment experience peak or heavy loads. If the utility has data only on the time of substation peaks, the load-weighted peaks can be used to distribute the demand-related distribution costs to hours and hence to classes.

### 11.6.1 Illustrative Methods and Results

The following discussion and tables show illustrative methods and results for several of the key distribution accounts, focused only on the capital costs. The same principles should be applied to O&M costs and depreciation expense. These examples use inputs from tables 5, 6, 7 and 27.

### Substations

Table 33 shows three methods for allocating costs of distribution substations. The first of these is a legacy method, relying solely on the class NCP at the substation level.<sup>169</sup> The second is an average-and-peak method, a weighted average between class NCP and energy usage. The third uses the hourly composite allocator, which includes higher costs for hours in which substations are highly loaded.

### Primary Circuits

Distribution circuits are built where there is an expectation of significant electricity usage and must be sized to meet peak demands, including the peak hour and other high-load hours that contribute to heating of the relevant elements of the system. Table 34 on the next page illustrates the effect of four alternative methods. The first, based on the class NCP at the circuit level, again produces unreasonable results for the street lighting class. The second, the legacy minimum system method, is not recommended, as discussed above. The third and fourth use a simple (average-and-peak) and more sophisticated (hourly) approach to assigning costs based on how much each class uses the lines and how that usage correlates with high-load hours.

### Transformers

Line transformers are needed to serve all secondary voltage customers, typically all residential, small general

<sup>169</sup> The street lighting class NCP occurs in the night, and street lighting is a small portion of load on any substation, so the street lighting class NCP load rarely contributes to the sizing of summer-peaking substations. The NCP method treats off-peak class loads as being as important as those that are on-peak. This is particularly inequitable for street lighting, which is nearly always a load caused by the presence of other customers who collectively justify the construction of a circuit.

**Table 34. Illustrative allocation of primary distribution circuit costs by different methods**

	Residential	Secondary commercial	Primary industrial	Street lighting	Total
<b>Class NCP: circuit (legacy)</b>	\$69,565,000	\$69,565,000	\$43,478,000	\$17,391,000	\$200,000,000
<b>Minimum system (legacy)</b>	\$113,783,000	\$51,783,000	\$24,739,000	\$9,696,000	\$200,000,000
<b>Average and peak</b>	\$67,041,000	\$67,041,000	\$53,997,000	\$11,921,000	\$200,000,000
<b>Hourly</b>	\$66,258,000	\$70,221,000	\$60,059,000	\$3,462,000	\$200,000,000

Note: Numbers may not add up to total because of rounding.

service and street lighting customers and often other customer classes as well. We present four methods in Table 35: two archaic and two more reflective of dynamic systems and more granular data. All of these apportion no cost to the primary voltage class, which does not use distribution transformers supplied by the utility.

The first method is to apportion transformers in proportion to the class sum of customer noncoincident peaks. This method is not recommended because it fails to recognize that there is great diversity between customers at the transformer level; as noted in Subsection 11.3.3, each transformer in an urban or suburban system may serve anywhere from five to more than 50 customers. The second is the minimum system method, also not recommended because it fails to recognize the drivers of circuit construction, as discussed in Section 11.2. The third is the weighted transformers allocation factor we derive in Section 5.3 (Table 7), weighting the number of transformers

by class at 20% and the class sum of customer NCP (recognizing that the diversity is not perfect) at 80%. The last is an hourly energy method but excluding the primary voltage class of customers.

#### Customer-Related Costs

The final illustration shows two techniques for the apportionment of customer-related costs, based on a traditional customer count and a weighted customer count. Even for simple meters used solely for billing purposes, larger customers require different and more expensive meters. There are fewer of them per customer class, but the billing system programming costs do not vary by number of customers. In addition, a weighted customer account is also relevant to customer service, discussed in the next chapter, because the larger use customers typically have access to superior customer service through “key accounts” specialists who are trained for their needs.

**Table 35. Illustrative allocation of distribution line transformer costs by different methods**

	Residential	Secondary commercial	Primary industrial	Street lighting	Total
<b>Customer NCP (legacy)</b>	\$32,258,000	\$16,129,000	\$0	\$1,613,000	\$50,000,000
<b>Minimum system (legacy)</b>	\$32,461,000	\$14,773,000	\$0	\$2,766,000	\$50,000,000
<b>Weighted transformers factor</b>	\$29,806,000	\$14,903,000	\$0	\$5,290,000	\$50,000,000
<b>Hourly</b>	\$23,810,000	\$23,810,000	\$0	\$2,381,000	\$50,000,000

Note: Numbers may not add up to total because of rounding.

**Table 36. Illustrative allocation of customer-related costs by different methods**

	Residential	Secondary commercial	Primary industrial	Street lighting	Total
<b>Unweighted</b>					
Customer count	100,000	20,000	2,000	50,000	172,000
Customer factor	58%	12%	1%	29%	100%
Customer costs	\$58,140,000	\$11,628,000	\$1,163,000	\$29,070,000	\$100,000,000
<b>Weighted</b>					
Weighting factor	1	3	20	0.05	
Customer count	100,000	60,000	40,000	2,500	202,500
Customer factor	49%	30%	20%	1%	100%
Customer costs	\$49,383,000	\$29,630,000	\$19,753,000	\$1,235,000	\$100,000,000

Note: Numbers may not add up to total because of rounding.

Table 36 first shows a traditional calculation based on the actual number of customers. Then it shows an illustrative customer weighting and a simple allocation of customer-related costs based on that weighting. Each street light is

treated as a tiny fraction of one customer; although there are tens of thousands of individual lights, the bills typically include hundreds or thousands of individual lights, billed to a city, homeowners association or other responsible party.<sup>170</sup>

<sup>170</sup> In some locales, street lighting is treated as a franchise obligation of the utility and is not billed. In this situation, there are no customer service or billing and collection expenses.

## 12. Billing and Customer Service in Embedded Cost of Service Studies

**M**any utilities classify billing and customer service costs, often termed retail service costs, as almost entirely customer-related and allocate these costs across classes based on the number of customers. This chapter describes how these costs can be allocated in a more granular and detailed way.

### 12.1 Billing and Meter Reading

Most utilities bill customers either monthly or bimonthly. The reason for this is relatively simple: If billed less frequently, the bills would be very large and unmanageable for some consumers; if billed more frequently, the billing costs would be an unacceptable part of the total cost. As noted in Subsection 3.1.5, billing closer to the time of consumption provides customers with a better understanding of their usage patterns from month to month, which may assist them in increasing efficiency. There are exceptions: Many water, sewer and even electric utilities serving seasonal properties may render bills only once or twice a year.<sup>171</sup>

It is important to recognize these cost drivers in the classification of billing costs. From a cost causation perspective, the reason for frequent billing is that usage drives the size of the bill. We receive annual bills for magazine subscriptions because the quantity we will use (one per week or month) is very small and predictable. In some states, rules of the regulatory commission require billing on a specified interval. For example, in Washington state, the rules require billing not less than bimonthly (Washington Administrative Code Title 480, Chapter 100, § 178[1][a]). In this situation, billing frequency in excess of that required by law or regulation is driven by consumption. The portion of the costs of reading meters and billing more frequently should be classified and

allocated according to appropriate measures of usage, rather than customer count.

Manual reading of the meters of large customers typically takes longer than for small customers, both because of travel distance among larger customers and the complexity of metering typical of large customers (TOU or demand-metered). In some cases, small customer meters are read manually but large customers are remotely metered; the additional costs of the equipment for that remote metering should be assigned to the classes that use remote metering. As noted in Section 11.5, unmetered customers such as streetlights should not be allocated meter reading costs.

For utilities with AMI, any meter reading costs arising from customers opting out of AMI should be recovered either from the opt-out customers or functionalized, classified and allocated in proportion to the AMI costs, because opt-outs are part of the cost of obtaining the benefits of AMI.

The costs of billing, payment processing and collections for special services (e.g., line extensions and relocations) can end up in Account 903 for some utilities. These are overhead costs, not customer costs, and should be either classified or allocated as an overhead expense.<sup>172</sup>

Some utilities provide on-bill financing for energy efficiency, renewable energy or demand response investments that the utility (or a third party) makes at the customer premises. Where this occurs, a portion of the billing cost should be assigned to the nonservice cost element.

### 12.2 Uncollectible Accounts Expenses

Uncollectible accounts expenses are the expenses from customers who have not paid their bills, due to financial

<sup>171</sup> This is also the case for California customers who opt out of AMI (California Public Utilities Commission, 2014).

<sup>172</sup> The same is true for any uncollectible charges for special services. If there

is direct assignment of uncollectibles, charges related to non-energy billings or claims should be segregated from the remainder of Account 904 and directly assigned as overhead expenses.



distress, bankruptcy or departure from the service territory.<sup>173</sup> Some analyses erroneously allocate the costs of former customers to the classes of current customers on a per-customer basis or by direct assignment. However, these costs are not caused by any current customer in any particular class.<sup>174</sup> Although certain accounts have unpaid electric bills, those accounts are former customers who are no longer members of any class.

Uncollectible accounts are related to class revenue in two ways. First, the higher the bills of a particular class, the more revenue is at risk of becoming uncollectible. Second, if the customer had shut down or left before rates were set, most of the costs reflected in the uncollectible bills would have been allocated to the remaining customers, in all classes. Hence, uncollectible revenues should be classified as revenue-related and allocated in proportion to revenues, not customer number.<sup>175</sup>

The treatment of four elements should be coordinated in the cost of service study:

- Uncollectible accounts expenses.
- Late payment revenues if charged to all classes (sometimes called forfeited discounts, often recorded in FERC Account 450 in the Uniform System of Accounts).
- Customer deposits, which protect utilities against uncollectibles and which offset rate base for most utilities in North America.
- Interest paid to customers on customer deposits.

If uncollectible accounts expenses are assigned as an overhead expense based on revenue, then all of these four items should be allocated based on revenue.

On the other hand, if uncollectible accounts expenses are directly assigned to the originating class or using a customer allocator, then late payment revenues and customer deposits should be assigned in the same manner.

Although an allocation based on revenue is more appropriate, the consistent allocation of these four items by either revenue or direct assignment may not have a large effect

on the cost of service study, because direct-assigned late payment revenues and deposits partly offset direct-assigned uncollectible accounts expenses.

The worst cost allocation outcome is inconsistency: assigning uncollectible accounts expenses largely to residential customers using direct assignment or a per-customer allocation while using a broad allocation method for late payment charges and customer deposits, even though both of these items are also largely paid by residential customers.

## 12.3 Customer Service and Assistance

Utilities frequently classify customer service and information expenses as customer-related and allocate them in proportion to customer number. This approach is not reasonable, because these expenses are more likely to vary with class energy consumption and revenues.

In general, larger customers have more complicated installations, metering and billing and warrant more time and attention from a utility. A utility customer service staff does not spend as much time and attention on each residential customer as on each large commercial or industrial customer, considering the fact that the larger customers may have bills 100 or 1,000 times that of the average residential customer. Indeed, most utilities have key accounts specialists — highly trained customer service personnel who concentrate on the needs of the largest customers. Large customers may also have more complex billing arrangements, multiple delivery points, demand charges, campus billing, interruptible rates and credits, transformer ownership credits and additional complications that require more time from engineering, legal and rate staff, supervisors and higher management, so the billing costs should be weighted proportionately to the customer classes with complex arrangements.

The alternative to a simple customer allocator for customer service costs may be to use a weighted customer

173 For most utilities, the residential class produces most of the uncollectible accounts expenses, in part because large customers are more often required to post deposits or demonstrate good financial standing. However, when large customers' bills are uncollectible, often due to bankruptcy, the amounts can be very large.

174 Texas has one of the strongest precedents on this issue for utilities not in ERCOT and therefore not subject to competition. See Public Utility Commission of Texas (2018, p. 47, findings of fact 303-305).

175 Texas and California have treated these costs as overhead costs, allocated by revenue to all customer classes.

allocator — in which larger customers are assigned a multiple of the costs assigned to smaller customers — or a combination of customer number and class revenue. The retail allocators should be derived from the relative cost or effort required per customer for each class.

Most utilities can segregate costs for key accounts and identify the customer classes for which these services are provided. Although these costs should be recorded in customer service costs (accounts 907 to 910), they can appear in other accounts. Wherever they appear, they should be assigned to the classes that use them. The costs should be assigned mostly to the largest commercial and industrial customers who receive the services, perhaps with a small amount allocated to classes with smaller nonresidential customers.<sup>176</sup>

Account 908, which FERC identifies as customer assistance expenses, contains general advice and education on electrical safety and energy conservation. Account 909 involves informational advertising. Those activities are generally not extensive (or expensive), and allocation is not usually controversial. But many utilities also book to this account energy efficiency expenditures, which can represent a few percent of consumer bills. If there are significant costs in this account, they are likely to be dominated by energy efficiency programs, which should be allocated as described in Section 14.I.

## 12.4 Sales and Marketing

Sales and marketing costs are often erroneously allocated by the number of customers rather than the purpose of sales and marketing expenses: to increase electric loads (e.g., by economic development or load retention). Since the purpose of these costs is to increase contributions to margin from new or existing customers, thereby reducing the need for future rate increases, the costs should be allocated by base rate revenue or another broad allocation factor such as rate base.

Some sales and marketing funds are used to promote important public policy programs (such as energy efficiency or electric vehicles, discussed further in sections 14.I and 7.I.3, respectively). Other sales and marketing efforts, however, may promote programs that ratepayers arguably should not fund at all (e.g., promotion of inefficient electric resistance heating by a utility that is almost entirely fossil fuel-based, through sponsorships and advertising) and should be examined closely in revenue requirements cases.

---

<sup>176</sup> A few large customers billed on multiple small or medium commercial tariffs may receive key-customer services, such as franchisees, government agencies and small accounts attached to large ones.

## 13. Administrative and General Costs in Embedded Cost of Service Studies

Utilities have very significant administrative overhead costs, including general plant (office buildings, vehicles, computer systems), labor costs (executive compensation, employee benefits) and the cost of outside services. Some cost of service studies functionalize a portion of each category of general plant and overhead costs to each of the first four functions. Other cost of service studies treat overhead as a function and allocate those costs to classes in proportion to the costs allocated to other functions, or on such drivers as the labor cost incurred by each of the other functions.<sup>177</sup> In this regard, the structure of the cost of service does not constrain or distort the allocation of overhead costs.

Overheads are costs that cannot be directly assigned to particular functions. The overhead category includes the capital costs and depreciation expenses recorded as general plant in accounts 389 to 399 (which includes office buildings and warehouses), property taxes in Account 408, employment taxes in Account 408.2 and the O&M expenses recorded as administrative and general in accounts 920 to 935.

### 13.1 Operations and Maintenance Costs in Overhead Accounts

Some costs included as A&G expenses may be more accurately treated as O&M for specific functions. Utilities do not all interpret the FERC Uniform System of Accounts in the same way. For example, a utility may include some or all of its expenses for procuring electricity and fuel in Account 920 (administrative salaries) and Account 921 (office expenses). These costs should be treated as energy-related, either by being refunctionalized to fuel costs and Account 557 (other

power supply expenses) or allocated in proportion to those costs or on energy. Similarly, some utilities include all or a portion of the major accounts expenses (discussed in Section 12.3) in accounts 920 and 921. These should be reclassified to customer service and assigned to the classes with the large customers who receive these services.

### 13.2 Labor-Related Overhead Costs

Some of the A&G accounts in the standard utility accounting systems serve a single function and are driven by a single factor. For example, employment taxes, pension expenses and other employee benefits vary with the number of employees and salaries and are generally functionalized in proportion to the labor in each function or are allocated using the special labor allocation factor calculated earlier in the process, based on how the labor costs in each function were previously allocated among the classes. If a labor allocator is not available, nonfuel O&M is often used as a reasonable proxy for labor.<sup>178</sup>

If the administrative overheads are available disaggregated by department or function, the human resources or personnel office should also be functionalized or allocated in proportion to labor. For administrative labor and other costs that cannot be directly functionalized, see Section 13.5.

### 13.3 Plant-Related Overhead

Accounts 924 (property insurance) and 925 (injuries and damages) are clearly plant-related and are generally functionalized or allocated in proportion to plant, with the exception of workers' compensation expenses in Account 925,

<sup>177</sup> In setting wholesale transmission rates, FERC allocates A&G and general plant costs among jurisdictions by labor, with the exception of property insurance Account 924 (by plant) and regulatory commission expenses (directly assigned). As described in sections 5.2 and 5.3, this treatment is overgeneralized.

<sup>178</sup> If nonfuel O&M is used instead of labor, transmission wheeling expenses, uncollectible accounts expenses and regulatory amortizations to operation and maintenance accounts should also be excluded, since these costs do not require supervision and administrative cost.

which are labor-related.<sup>179</sup> The same is true for property taxes that are based on the assessed value of each utility facility.<sup>180</sup> Typically, an allocator based on net plant (or net plant less deferred taxes) is used, but the allocation should reflect the method by which taxes are assessed in each state.

## 13.4 Regulatory Commission Expenses

The benefits to customers of the regulatory oversight funded through FERC Account 928 will normally be distributed more in proportion to the classes' total bills, including both investment-related costs and operating expenses, rather than to the number of customers in the classes. In terms of cost causation, the regulatory assessment covers expenditures on many types of proceedings, including (depending on the jurisdiction) rate cases, resource planning, project certification, review of investments, power purchase contracts and fuel expenses. Demand and energy use are the major contributors to the size of the assessment and the cost of its regulatory efforts. Depending on the jurisdiction and the distribution of the regulator's efforts, the most equitable allocator may be class revenues or energy consumption.<sup>181</sup>

## 13.5 Administrative and Executive Overhead

Many of the standard A&G accounts serve multiple functions. Administrative salaries pay employees in human resources, financing, public relations, regulatory affairs, the legal department, purchasing and senior management. Some of their work is driven by employee numbers (e.g., human resources), others by capital investment (finance) and most by a mix of labor, fuel procurement, nonfuel expenses and capital investments, including dealing with disputes with

suppliers, customers, regulators and other parties. Outside purchased services may include consultants on new power plants, fuel and equipment procurement, power transactions, environmental compliance, worker safety and many other activities.

These costs are driven by the utility's entire operation, including labor, other O&M and plant investment. If these corporate overheads can be differentiated in sufficient detail (sections 13.1, 13.2 and 13.3), they can be functionalized or allocated to specific cost categories. Otherwise, these costs can be allocated in proportion to class revenue (or the total of other cost allocations).

Utilities agree to franchise payments (in Account 927) to gain access to customers and the associated revenues; thus franchise payments should be allocated in proportion to total revenues or other allocated costs.

## 13.6 Advertising and Donations

Some utilities assign Account 930.1 (general advertising) or certain donations as customer-related. This treatment is erroneous. General advertising is not trying to inform customers of anything they need to know about their regulated utility service (the purpose of Account 909) or sell them anything (Account 913). Rather Account 930.1 includes "cost of advertising activities on a local or national basis of a good will or institutional nature, which is primarily designed to improve the image of the utility or the industry" (18 C.F.R. § 367.901[d]). If allowed in rates at all, these costs are clearly overheads, even if the expenditures are largely intended to affect the opinions of residential customers (or voters). To the extent that some donations are allowed in rates (as in Texas), they also are image-building and charitable overhead and, as such, should not be assigned by the number of customers.

179 As a refinement, a study could be done to determine workers' compensation costs by functions. Customer service representatives (largely customer-related in Account 903) are likely to have lower workers' compensation costs than power plant operators or power line workers.

180 For publicly owned utilities, the equivalent may be payments in lieu of taxes.

181 Many utilities allocate these costs by base rate revenues; a more appropriate allocator would be total revenues given that fuel and other costs collected in riders are also regulated and planning and certification activities related to the rider costs constitute a significant portion of the burden on regulators.

# 14. Other Resources and Public Policy Programs in Embedded Cost of Service Studies

## 14.1 Energy Efficiency Programs

**E**nergy efficiency costs have three effects on the revenue requirement that will be recovered through rates. First, energy efficiency shrinks the size of the pie of non-energy efficiency costs that have to be split up, because the utility will need less generation, transmission and distribution in the long run, and utilities that own generation may be able to earn some export revenues to offset other costs. Since utilities generally undertake energy efficiency only if it is less expensive than the avoided costs (sometimes measured as short run, sometimes as long run, and including or excluding environmental costs), energy efficiency tends to reduce total costs, at least in the long term.

Energy efficiency programs typically reduce generation, transmission and distribution costs, and hence also some of the associated overheads, but not most retail service costs, such as metering and billing.<sup>182</sup> In restructured utilities, energy efficiency load reductions tend to reduce the prices that all customers pay for generation services, as well as avoiding transmission and distribution investments. These benefits typically are dominated by energy savings, with a portion being demand-related. Some utilities collect energy efficiency costs from all customers, on an equal cents-per-kWh basis or using an energy/demand allocator. Where this is done, the allocation of program costs should generally follow the framework for revenue collection.

Second, a program that reduces the loads of one class shrinks its share of the cost pie, increasing other classes' shares of the pie. For the participating class, the reduction in both the size of the pie and the class's share of the pie reduces customers' cost allocation. For each class participating in each program, the program reduces the bills of participants and the costs allocated to the class. Thus, some utilities have assigned the costs of each energy efficiency program to the

participating classes. But for some other class, the increase in its share of the costs may be either larger or smaller than the effect on the size of the total pie, so its cost allocation may either rise or fall due to the energy efficiency.

Thus, cost-effective energy efficiency, with the costs allocated to classes based on the class share of the system benefits, can result in nonparticipating classes paying more than they would without energy efficiency. Conversely, assigning the costs directly to the participating class or classes can result in the participants paying more for energy efficiency programs than they benefit from the shrinking of the revenue requirements and of their share, leaving them worse off. These are extreme situations. With highly cost-effective programs and broad participation, all classes are very likely to benefit from energy efficiency, no matter how the costs are allocated. But the net benefits can be inequitably allocated.

The cost effects of energy efficiency differ between the short term and the long term. The costs of energy efficiency investment are often incurred in the year of program implementation, while the benefits stretch on for many years. In 2018, the customers will be paying roughly the costs of the 2018 program, while nonparticipating customers in 2018 are primarily receiving the benefits of energy efficiency investment that occurred in the past. This could be another source of misalignment between cost recovery and benefits, particularly if there are changes over time in the cost recovery method or the relative benefits to each customer class.

Energy efficiency costs are typically caused by the opportunity to reduce total costs to consumers. For most costs, revenue requirements would be lower if customers did less to require the utility to incur those costs. Customers

---

<sup>182</sup> Energy efficiency programs targeted to low-income customers can reduce collection costs, uncollectibles and other burdens on the utility and other customers.

whose load growth requires upgrades to their service drops and transformers, extension of three-phase primary distribution and retention of more hydro energy that could have been exported would increase costs to the system. The same is true for customers who want their service drops underground for aesthetic reasons. Other customers should not bear those costs, so the costs are assigned or allocated to the participating class and billed (more or less) to the customer demanding the service. If customers do not want to pay the costs, they should not increase their load or request more expensive services.

Unlike other costs, energy efficiency costs produce benefits for the participating class and entire system. Utilities do not want to discourage participation in energy efficiency efforts, and they recognize there are benefits beyond the participant. In principle, the cost of service study might allocate all energy efficiency costs to the participating rate classes, offset by all the system benefits of energy efficiency. In practice, it would be difficult. The cost savings in 2020, for example, will result from expenditures made in earlier energy efficiency programs, and relatively little savings will be realized for nonparticipants in 2020 from the activities underway in that year. Determining the load reductions in 2020 from those prior years' programs, the cost savings from the load reductions and the class responsibility for those savings would be quite complex.

The allocation of energy efficiency costs should reflect both the system benefits from energy efficiency and the benefits to the participating classes, while avoiding making any class worse off. If a utility has high avoided costs and low embedded costs, the first solution may result in a class being charged for all the costs of the energy efficiency it undertakes, even though most of the benefit flows to other classes, leaving the participant class worse off than if it had not participated. That outcome would not be equitable and would not encourage the class to engage in further efficiency. If a utility has relatively low avoided costs and high embedded costs, the second option may result in the participating class's revenue requirements falling by more than the total net benefit of the energy efficiency program, leaving other classes with higher bills. That outcome would also be inequitable and may inspire each class

The allocation of energy efficiency costs should reflect both the system benefits and the benefits to the participating classes, while avoiding making any class worse off.

to oppose energy efficiency proposals for the other classes.

The allocation of energy efficiency program costs should avoid both of these extremes, which may lead to the use of a split between energy-related and demand-related, direct assignment to participating classes or a combination of the two approaches (such as 50% of the costs being directly assigned and the rest allocated based on energy usage).

To avoid these problems, the utility could estimate the effects of recent or planned energy efficiency on revenue requirements for each class, for alternative allocations.

This analysis would include the long-term annual revenue requirements for three cases:

1. Actual or planned energy efficiency spending and load reductions, with energy efficiency costs assigned to the participating classes and system revenue requirements allocated roughly as they would flow through the cost of service study.
2. Actual or planned energy efficiency spending and load reductions, with energy efficiency costs allocated in proportion to avoided costs (using weighted energy or other allocators reflecting the composition of avoided costs) or total revenues, and system revenue requirements allocated roughly as they would flow through the cost of service study.
3. No energy efficiency, resulting in higher loads, higher energy costs, lower export revenues and higher T&D costs.

The difference between case 1 and case 3 would show the effect on rate classes of assigning energy efficiency costs by class, and the difference between case 2 and case 3 would show the effect on rate classes of allocating energy efficiency costs in proportion to the system benefits. Based on that analysis, the cost of service study should use an allocation approach that is fair to all classes, avoiding a situation in which one class is paying for its own energy efficiency efforts

that are disproportionately benefiting other classes or, conversely, paying for energy efficiency for other classes and receiving little of the benefit.

## 14.2 Demand Response Program and Equipment Costs

Demand response programs may avoid generation, transmission and distribution investments depending on the specifics of the program and may avoid high purchased power and transmission costs incurred for peak periods or contingencies. The costs of marketing the programs, and even payments to participants, may appear in a customer service account, such as Account 908. Despite their location in this account, the costs are not customer-related. They are resource costs that benefit all customers.

Utility demand response programs are designed to avoid capacity and energy costs and line losses for short-duration loads during times of system stress. The program costs may include investments and expenses at utility offices (computers, software and labor), installations on the distribution system (sensors and communication equipment) and installations on customer premises (controls). These costs are incurred to avoid peak capacity (and sometimes associated energy) costs on the generation system and sometimes on the transmission and distribution systems as well.

The demand response costs should be functionalized across all affected functions and allocated based on metrics of peak usage that relate to the period for which they are incurred — the hours contributing to highest stress. Where demand response provides benefits outside the highest-stress hours, such as by providing operating reserves (which reduce the need to run uneconomic fossil-fueled generation), a portion of the demand response costs should be allocated to the hours when demand response provides those benefits.

Some investments provide not only demand response but also load shifting or energy efficiency. Examples include controls for water heaters, space cooling and space heating and swimming pool pumps. These programs can reduce energy costs, including increasing load in periods with excess renewables that would otherwise be curtailed. Allocation of these costs should reflect the mix of benefits, including peak reductions, reduced reserve costs and reduced energy costs.

For programs that are operated only infrequently under conditions of bulk generation shortage (e.g., industrial interruptible load), the loads that were curtailed should be added back to the relevant class loads, and the costs of the programs — both outreach and incentive payments — should be treated as purchased power and allocated either to generation demand or to the specific hours when the program could be called.<sup>183</sup> Some utilities remove interruptible demand from the associated class load before allocating costs and allocate the costs of the program back to the participating class; that approach can be reasonable, as long as the interruptibility provides benefits equivalent to the utility functions for which the class allocation is reduced.<sup>184</sup> In no case should a cost of service study both reduce the participant class loads for demand response and allocate the costs to all classes; that would double count the benefit to the participating class.

Other programs with more frequent operations or wider benefits than emergency bulk generation should be assigned more broadly to generation, transmission and distribution based on program design. For example, if a demand response or storage program is developed simultaneously to improve the reliability and efficiency of the distribution system (i.e., a targeted nonwires alternative investment program) and to provide bulk power benefits, the costs could be assigned partly to each function as discussed above.<sup>185</sup>

In certain cases, utilities may directly own demand

183 It is generally inappropriate to pay customers to participate in a demand response program, subtract demand response capacity from the loads used for deriving allocation factors and also allocate the costs of the program to nonparticipating classes. Paying the participants and reducing their class loads pays twice for the same resource. The participants should be paid, of course, but all load should pay for the service that the program provides.

184 Many legacy interruptible rates require long lead times, allow only a limited number of annual interruptions, limit the length of each

interruption and allow customers to ride through an interruption for a modest penalty. These rates may reduce the cost of serving the interruptible customers but do not fully replace equivalent amounts of generation and transmission.

185 Although a program theoretically could be designed only to have targeted distribution benefits without bulk power benefits, that may not be the most cost-effective program design.

response or load management equipment at customer premises to enable utility or consumer control of space conditioning, water heating, irrigation pumping and other loads. This type of investment's primary purpose is to enable peak load management, but it may also provide ancillary services and shifting of energy between periods. Although located within the distribution system, it is functionally different from most other distribution system plant in that it directly offsets the need for generation and transmission expenditures. For this reason, these costs should be classified and allocated differently from other distribution plant.

### 14.3 Treatment of Discounts and Subsidies

The decision to reduce the revenue responsibility of some customers increases the revenue responsibility of other customers. There are a variety of reasons for legislatures and regulators to provide discounts. Some are cost-based (such as for off-peak or interruptible service), in which case other customers are not truly providing a subsidy. Other discounts are truly subsidies, most commonly for low-income residential customers (unless justified by a substantially different load profile) and for financially distressed businesses — especially agricultural irrigation<sup>186</sup> and businesses that are major employers.

A common example is the difference between the revenues that low-income consumers would have paid under the standard residential tariff (or a tariff designed to recover the costs appropriately allocated to a low-income class)

and what they actually pay under discounted low-income tariffs.<sup>187</sup> Where those subsidies exist, the cost of service study must address how to recover the subsidies through adding to the revenue responsibility of other customers. The decision as to whether the subsidy should be recovered from the class whose members receive the discount or from all customers is a matter of public policy, which is sometimes settled by the legislature<sup>188</sup> and other times left to the regulator's judgment. If the subsidy is recovered within the discounted class, the discount does not affect cost allocation to the class because the costs remain within the class and the subsidy shows up in the form of reduced revenues (and may thus result in higher rates for the remainder of the residential class). But if the subsidy is to be redistributed to other classes, it is appropriate for inclusion in the cost of service study as a cost or revenue adjustment to be apportioned across classes.<sup>189</sup>

As a practical matter, recovering a subsidy from the nondiscounted customers in the class receiving the discount may just push more of those customers into distress. Hence, the most reasonable manner of recovering a subsidy will vary: If the residential class is mostly affluent, with small pockets of poverty, dealing with a low-income discount entirely through rate design in the residential class may be appropriate. But if most of the residential class is in a tenuous financial condition, but the commercial and industrial classes in the territory are thriving, spreading the subsidy costs over all classes may be most appropriate, with a net credit to the residential class and charges to other classes, perhaps on an energy basis.

186 For example, Nevada has a requirement that certain irrigators receive low rates: "IS-2 is a subsidized rate that NV Energy charges eligible agricultural customers who agree to interruptible irrigation pump service during certain situations. This service is applicable to electricity used solely to pump water to irrigate land for agricultural purposes. Agricultural purposes include growing crops, raising livestock or for other agricultural uses which involve production for sale, and which do not change the form of the agricultural product pursuant to NRS 587.290" (NV Energy, n.d.).

187 Low-income subsidies may be motivated by a combination of social concerns (such as reducing the burdens on needy customers and avoiding health-related problems of customers unable to heat or cool their homes), utility practicality (reducing bad debt and collection expenses) and cost causation. Low-income consumers are typically low-use customers and may tend to have less temperature-sensitive load

that drives utility system peaks. Depending on the composition of the low-income population, they may also be at home in a different pattern than higher-income customers. A time-differentiated cost study may illuminate these differences.

188 For example, California Public Utilities Code § 327(a)(7) requires that the low-income electric rate for its IOUs be allocated by equal cents per kWh to all customers except recipients of the low-income rate and street lighting customers.

189 For example, a pro forma adjustment to revenue for each class (positive to the residential class; negative to other classes) would spread the subsidy across all the classes that the regulator concludes should contribute to this service.



# 15. Revenues and Offsets in Embedded Cost of Service Studies

## 15.1 Off-System Sales Revenues

**S**ome retail cost of service studies treat wholesale sales as a separate class and allocate costs to the off-system customers. The cost of service study does not necessarily lead to any change in the off-system customers' charges (which are typically set by contracts, markets or FERC) but does help the regulator determine what share of the revenue requirement not recovered by FERC-regulated sales should be borne by each retail class. Alternatively, many utilities allocate all their costs to the retail classes and credit the export revenues back to the retail classes.<sup>190</sup>

In the latter approach, utilities sometimes allocate wholesale revenues to classes in proportion to their allocation of generation costs. Under this type of allocator, the greater the rate class's demand and usage, the greater its share of the off-system sales revenue. The problem with this approach is that some classes (e.g., industrials) use most of the generation capacity allocated to them throughout the year, while other classes typically pay for capacity they use in their peak season but which is available for sale in other seasons. Off-system sales revenues depend not only on the retail customers' financial support of the resources (including generating capacity) from which off-system sales are made but also on the extent to which class load shapes leave resources available to make those sales.

A more appropriate allocator would reward a class for having lower demand and usage, perhaps on a monthly basis, thereby leaving generation (and transmission) capacity available to support the off-system sales. In other words,

the revenue from off-system sales should reflect classes' contribution to the availability of capacity to make the sales.<sup>191</sup>

## 15.2 Customer Advances and Contributions in Aid of Construction

As discussed in Section 11.2, most utilities charge new customers or new major loads for expansion of the delivery system, at least in some circumstances. Utilities frequently require customer advances for construction costs when they are asked to build a facility to accommodate subsequent load growth (e.g., to connect a subdivision or commercial development before some or perhaps any of the units are built and sold). The utility requires the advance to transfer to the developer the risk that the load will never materialize, or that load will grow more slowly than expected. As the load materializes, the advances are refunded to the developer. Those advances provide capital to the utility and generally are treated as a reduction of rate base; that cost reduction should be directly assigned to the customer classes for whom the advances were made.

Contributions in aid of construction are similar to customer advances but are applied in situations in which the utility does not expect the incremental net revenues from the load to cover the entire cost of the expansion. The contributions are thus a permanent payment to the utility, offsetting part of the capital cost. Contributions in aid of construction should be treated similarly to customer advances, allocated as

<sup>190</sup> The same approach is possible with retail customers whose rates are fixed under multiyear contracts. Off-system sales revenues may vary considerably, based on market conditions, and are therefore often included in a fuel adjustment clause or similar rider between rate cases, while the base allocation is typically established in a general rate case.

<sup>191</sup> MidAmerican Energy in Iowa proposed an hourly cost allocation method for capacity and energy in a recent case but also argued that if the Iowa Utilities Board were to use its traditional "average and excess demand" method instead, off-system sales margins should be allocated by excess demand, not by energy. "MidAmerican believes it is more appropriate to allocate wholesale margins (revenues less fuel costs) based on the excess demand component of the [average and excess] allocator, as it is from excess generation capacity that wholesale sales can be made" (Rea, 2013, p. 19).

rate base reductions for the class for which the contributions were made. Where that is not possible, they should be applied as realistically as possible to offset the rate base for the types of facilities for which the contributions were collected.

As noted in Section 12.2, customer deposits that offset rate base should be allocated consistently with uncollectible accounts expenses and late payment revenues.

### 15.3 Other Revenues and Miscellaneous Offsets

The treatment of other operating revenues affects customer class allocation. Some cost of service studies allocate all these revenues proportionally to a broad-based factor such as base rate revenue. Others do a more granular analysis. The granular analysis is preferable analytically because it is closer to the basis for the revenues.<sup>192</sup> There are several types of other operating revenue. Three of the largest are:

- Late payment revenues.
- Revenues for auxiliary tariffed services.
- Rents and pole attachment revenues.

As discussed in Section 12.2 earlier, late payment revenues need to be treated consistently with uncollectible

accounts expenses and customer deposits.

Auxiliary tariffed service revenues result from directly charging customers for certain actions that customers take. The large majority of tariffed revenues result from items such as service establishment charges, charges for reconnection after disconnection, field collection charges and returned check charges. These revenues should not be allocated broadly because the revenues are predominantly paid by residential customers and the costs that these revenues reimburse are predominantly in customer-related accounts that are largely assigned to residential customers (accounts 586, 587, 901 to 903 and 905). These revenues should be directly assigned to the customer class that pays them or (if that is not possible) allocated in proportion to customer accounts expenses excluding uncollectibles.

Tariffed service charges for costs associated with opting out of AMI should be allocated in the same way as the costs of AMI opt-outs (as discussed in Section 12.1).

Rents should be allocated to the function causing the rents (distribution lines, office buildings, etc.). In particular, pole attachment revenues from cable and telecommunications companies should be allocated in proportion to poles.

<sup>192</sup> For example, assigning revenues from service establishment charges based on total base rate revenue would result in large customers, who rarely move, receiving revenue as if they had moved many times in a single year.

## 16. Differential Treatment of New Resources and New Loads

In some situations, regulators have treated new resources or new loads using considerations that do not fit neatly into the embedded cost of service study framework. In particular, equity may sometimes be improved by reflecting the history and projections of class loads. However, there are risks in adopting such an approach, particularly within customer classes. Regulators should be careful to ensure adoption of such techniques is not arbitrary or discriminatory and is grounded in solid reasoning.

These differential treatment techniques are sometimes referred to as incremental cost of service studies<sup>193</sup> and can be conceptualized as either applying two different embedded cost techniques or combining an embedded cost technique with a marginal cost technique. In either case, the defining characteristic of these methods is the recognition that the costs associated with load growth in the recent past or the relatively near future, which typically might be several years, are being driven by a specific class or subclass of customers.

Incremental cost considerations are sometimes used to address a special circumstance that justifies differential treatment for particular classes or subclasses of customers within the context of an embedded cost study. Examples include:

- Allocating legacy low-cost generation resources to classes in proportion to their contribution to loads in a past year (perhaps the last year in which those resources were adequate to serve load), with the higher incremental costs of newer generation allocated to classes in proportion to their load growth since that base year.
- Setting the revenue requirements for selected classes or subclasses at levels below the general cost allocation but

higher than near-term incremental costs; for example, in determining how to apportion the cost burden of economic development programs or low-income assistance programs.

- Developing desired end uses that may require preferential rates in the short term (e.g., electric vehicles or docked ships that would otherwise be burning oil) to provide a societal benefit or stimulate a desirable market. In most cases, the differential treatment is intended to protect customers in the other classes from higher costs of new resources or from bearing a larger share of legacy costs.

### 16.1 Identifying a Role for Differential Treatment

A study with differential treatment typically looks at the costs the system will incur within a relatively short time horizon to serve new load or retain existing load. The costs that may differ between the legacy loads and resources and incremental loads and resources include the variable costs of existing generation resources and the costs of new supply resources, transmission projects and distribution upgrades.<sup>194</sup> In each case, inequities or inefficiencies arise because costs do not scale proportionally to the drivers, such as load. If the utility has committed generation resources, with low variable costs, in excess of its requirements and has overbuilt most of its transmission and distribution circuits, incremental costs will tend to be below average costs.<sup>195</sup> In contrast, in a period of tight supply, the near-term costs of running expensive generation and adding generation, transmission and distribution resources may be higher than embedded costs.

193 The term “incremental cost of service study” in this case is not used in the same sense as a marginal cost of service study, where the marginal impact of load patterns is measured.

194 In principle, there could be similar differences in the costs of some customer service elements, such as between an existing billing system that would be adequate indefinitely for the existing accounts and an expensive new system that would be required if the utility adds accounts.

195 Surplus capacity does not always imply that incremental costs are below average costs. If the utility can save money by selling surplus generation resources or shutting them down, the incremental cost of retaining or increasing load may be as high as the embedded costs or nearly so.

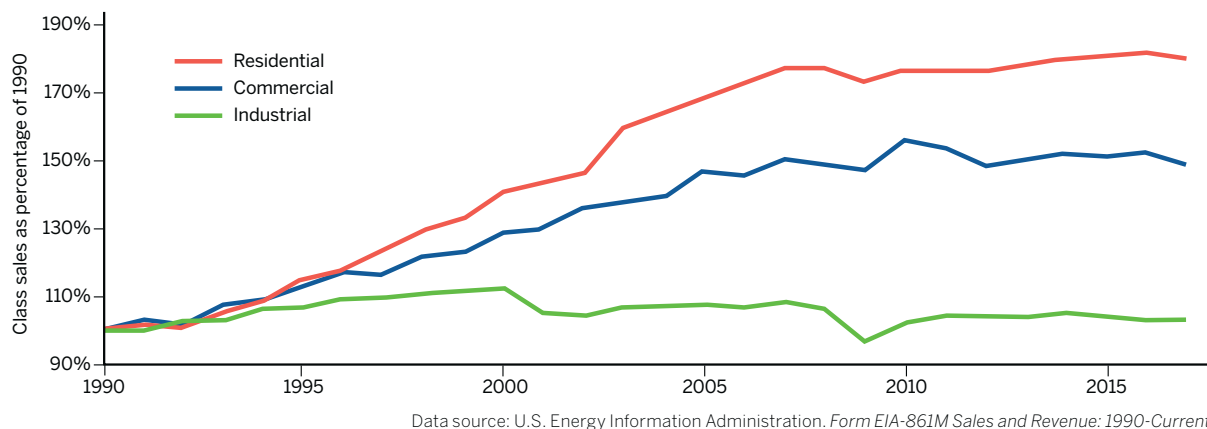
**Figure 43. US load growth by customer class since 1990**

In some cases, growth has profound impacts on system costs, and special consideration of differential growth rates may be important to the regulator. Load growth at certain hours may be beneficial, while load growth at other hours may be problematic, requiring new resources. Those facilities may be more expensive than the existing equivalents due to any of the following:

- **Inflation:** Equipment built 20 years ago will usually be less expensive than the same equipment installed today; buying new sites for generation or substations may be many times the embedded costs of sites purchased in the 1950s.
- **Location:** Existing generation may be located near load centers, while new generation may be required to locate much farther away; the existing distribution system may be relatively dense, while the new loads require long line extensions.
- **Regulatory standards:** The utility may be required to locate new lines underground;<sup>196</sup> environmental standards for routing, construction and emissions are often more restrictive for new resources than existing ones.
- **Exhaustion of favorable opportunities:** A utility may have relied historically on low-cost hydro, while its new resources may be much more expensive; ideal sites for wind power tend to be the first ones developed, while less favorable sites are generally developed later.

- The particular needs of the growing loads, such as higher reliability or power quality, or three-phase service in areas with mostly single-phase service.

Most traditional embedded and marginal cost studies do not take differential growth into account. U.S. residential loads grew about 50% from 1990 to the 2008 recession and not at all since; commercial loads grew about 80% up to the recession and slightly since; and total industrial electricity consumption grew slowly to about 2000 and has declined slowly since, as shown in Figure 43 (U.S. Energy Information Administration, n.d.-b). Load growth patterns for individual utilities may be much more disparate, both among customer classes and between clearly distinguishable subclasses (such as urban and rural, small markets and big-box stores, or farms and mines).

Where incremental costs are much higher than embedded costs, the difference may be assigned to classes in proportion to their growth. If it is a subset of a class that is growing quickly, there may be a rationale for adopting separate tariffs or riders for new customers within that class or for an identifiable subgroup contributing to higher costs (e.g., large vacation homes or data centers). The correct answer in some cases is the creation of a new customer class with separate load and cost characteristics. Beyond cost allocation, the incremental costs may be reflected in rate design and connection fees. For

<sup>196</sup> Undergrounding may also be required by the difficulty in finding room for overhead transmission through built-up areas.

**Figure 44. Estimated revenue and cost from serving additional electric vehicle load**

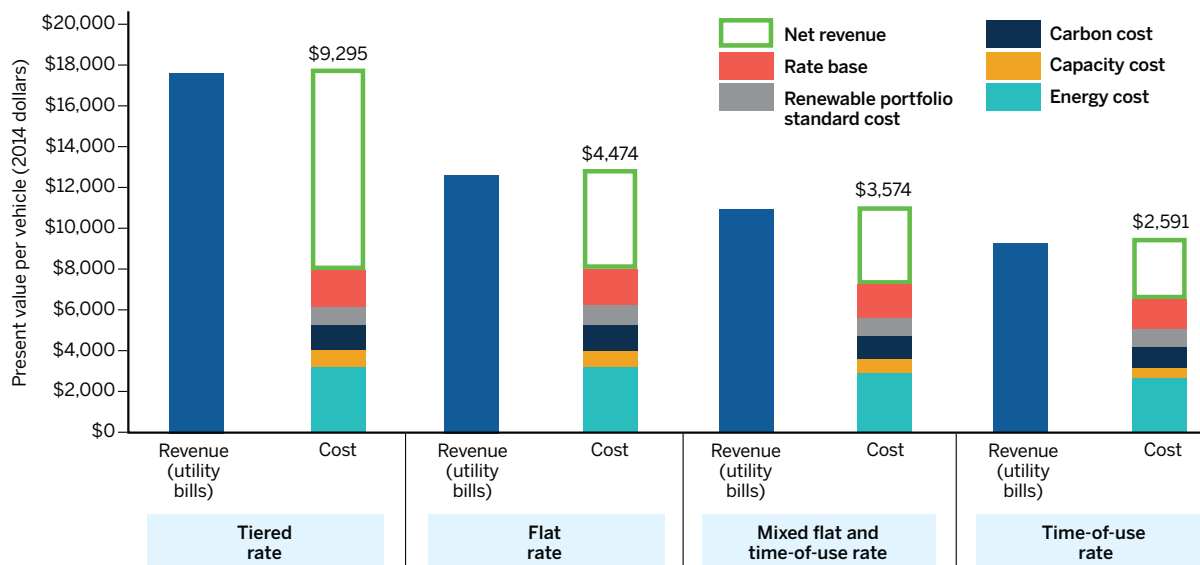

Source: Energy and Environmental Economics. (2014). *California Transportation Electrification Assessment – Phase 2: Grid Impacts*

example, higher costs may also be allocated to the entire class but collected through a rate element (e.g., consumption over twice the monthly average) that aligns well with the customers causing the additional costs.

In some situations, load growth can reduce system average costs, at least temporarily, by spreading embedded costs over more units of sales. Regulators sometimes reduce rates to a special class or particular customers who will demonstrably generate more revenue with the lower rates, such as with economic development and load retention rates. At the present time, this may apply to beneficial electrification of transportation. Figure 44 shows a calculation of how additional electric vehicle load would generate additional net revenue, thus creating opportunity to benefit new EV users and existing consumers (Energy and Environmental Economics, 2014).

Some generation resources, such as federal hydropower entitlements, are made available to utilities by statute to serve particular loads, such as residential customers. Many regulators allocate those benefits to the classes whose entitlement to the power makes it available to the utility.<sup>197</sup>

## 16.2 Illustrative and Actual Examples of Differential Treatment

Table 37 on the next page shows an illustrative incremental cost study. In this simplified example, costs are rising; many are directly related to growth, but some are not. Costs relating to growth are assigned to the classes in proportion to their growth. Costs not related to growth are assigned based on each class share of current usage. The result, where both classes start at the same usage level but one grows four times as quickly as the other, is that the growth-related costs are assigned to the growing class, increasing its revenue responsibility if its costs are greater than current rates or decreasing its responsibility if its costs are lower than current rates.

In this illustration, both classes had equal rates in the previous rate proceeding. But costs have risen for both nongrowth categories (inflation) and growth categories (new resources and new distribution capacity). After application of an incremental cost study, the slow-growing class is assigned a rate averaging

<sup>197</sup> Those benefits are often reflected in rate design by development of a lower first energy block to ensure that each eligible customer gets an appropriate share of the benefit.

14 cents per kWh, while the fast-growing class is assigned an average of 17 cents per kWh. In the opposite situation, where incremental costs are lower than average costs, the growing class might be assigned lower costs.

### 16.2.1 Real-World Examples

This section describes specific applications of differential treatment in cost allocation to illustrate the range of concepts.

#### Seattle City Light 1980 Cost Allocation

In 1980, Seattle City Light, a municipal utility, was experiencing rapid growth in commercial loads with stagnant to declining industrial loads. It recognized that continued growth would require it to commit to new nuclear or coal plants with incremental power costs much higher than the embedded hydro resources. Average rates were about 2 cents per kWh, while just the expected cost of new generation resources was about five times that level.

Even without the new resources, Seattle City Light required a rate increase and developed an interclass cost allocation method along the following lines:<sup>198</sup>

- Starting with historical-year sales by class and prior year revenues by class.
- Assigning the costs related to growth in proportion to the sales to each class, using forecast sales and expected long-term resource acquisition costs.
- Apportioning the residual revenue requirement increase on a uniform basis to all customer classes.

**Table 37. Illustrative cost study with differential treatment of new resources**

	Total	Residential	Commercial and industrial
<b>Revenues at previous usage</b>	\$200,000,000	\$100,000,000	\$100,000,000
<b>Previous usage (MWhs)</b>	2,000,000	1,000,000	1,000,000
<b>Current rates per kWh</b>	\$0.10	\$0.10	\$0.10
<b>Usage</b>			
In current rate period (MWhs)	2,250,000	1,050,000	1,200,000
Growth from previous (MWhs)	250,000	50,000	200,000
Class share of growth		20%	80%
Class share of current		46.7%	53.3%
<b>Growth-related costs</b>	\$100,000,000	\$20,000,000	\$80,000,000
<b>Nongrowth costs</b>	\$50,000,000	\$23,335,000	\$26,667,000
<b>All increased costs</b>	\$150,000,000	\$43,335,000	\$106,667,000
<b>Total revenue requirement</b>	\$350,000,000	\$143,335,000	\$206,667,000
<b>Usage in current rate period (MWhs)</b>		1,050,000	1,200,000
<b>New rates per kWh</b>		\$0.14	\$0.17

Note: Numbers may not add up to total because of rounding.

This approach resulted in an average increase in residential rates, an above-average rate increase to commercial customers and a below-average rate increase to industrial customers. It achieved the stated equity goal of charging more to the fastest-growing customer class — that is, the class that was driving the lion's share of the incremental costs.

#### Vermont Hydro Allocation

The state of Vermont receives an allocation of low-cost power from the Niagara and St. Lawrence hydroelectric facilities owned by the New York Power Authority, pursuant to a requirement in statute that allowed construction of the plants, to provide power to Vermont.<sup>199</sup> The Burlington Electric Department allocates this power to the residential customer class.<sup>200</sup> Other classes do not benefit from this resource. This is a method of ensuring that limited low-cost

198 One of the authors of this manual, Jim Lazar, participated in this proceeding on behalf of an intervenor.

199 "In order to assure that at least 50 per centum of the project power shall be available for sale and distribution primarily for the benefit of the people as consumers, particularly domestic and rural consumers, to whom such power shall be made available at the lowest rates reasonably possible" (Niagara Redevelopment Act, Pub. L. No. 85-159, 16 U.S.C. § 836[b][1]). NYPA was required to provide a portion of the power to public bodies and co-ops in neighboring states (16 U.S.C. § 836[b][1]). Thus, the resources

were made available to the Burlington Electric Department for the purpose of benefiting residential customers.

200 The Burlington Electric Department also uses that allocation to create an inclining block rate design consisting of a customer charge to cover billing, collection and other customer-specific costs; an initial block priced at the New York Power Authority cost plus average T&D costs; and a tail block that pays for other generation resources plus average T&D costs. See Burlington Electric Department (2019).

resources are equitably allocated to the customers for whom the New York Power Authority provides the power and that all customers share the cost of incremental resources needed to serve demand in excess of incremental usage.<sup>201</sup>

### Northwest Power Act — New Large Single Loads

The Pacific Northwest Electric Power Planning and Conservation Act of 1980 provided, among other things, for division of the economic benefits of the federal Columbia River power system among various customer groups and rate pools (Pub. L. No. 96-501; 16 U.S.C. § 839 et seq.). The act set forth a specific mechanism for the Bonneville Power Administration to charge a price based on new resources to “new large single loads” (discrete load increments of 10 average MWs or 87,600 MWh per year, such as might be experienced if a new oil refinery were built). This provision was intended to protect existing consumers from rate increases that could result from new very large loads attracted by the low average generation costs in the region, in a period in which new resources were very expensive. Table 38 shows average rates for Bonneville Power Administration by category for recent years, including a higher rate for new resources (Bonneville Power Administration, n.d.).<sup>202</sup>

**Table 38. Bonneville Power Administration rate summary, October 2017 to September 2019**

Rate category	Average rates per MWh
Priority firm public utility average	\$36.96
Priority firm public utility Tier 1	\$35.57
Priority firm – IOU residential load	\$61.86
Industrial power	\$43.51
New resources	\$78.95

Source: Bonneville Power Administration. *Current Power Rates*

201 This same concept has been the foundation of inclining block rates in Washington state and Indonesia.

202 The average rates subsume a variety of fixed and variable charges.

203 Nova Scotia Power was not part of an energy market and had limited connections to its only neighboring utility (NB Power, which is also not part of an energy market), and its marginal generation resources are coal

### Nova Scotia Power Load Retention and Economic Development Rates

In 2011, falling global demand for paper resulted in the bankruptcy and shutdown of two paper mills that were Nova Scotia Power’s largest customers, which accounted for about 20% of its sales and 12% of its revenues. The mills had been major employers, both directly and as purchasers of wood harvested from forests in the province. A buyer emerged for the larger of those facilities, contingent on a variety of supportive policies from the provincial and federal governments, including favorable tax treatment and rates.

Nova Scotia Power proposed and the Nova Scotia Utility and Review Board approved (with modifications) a load retention rate that would charge the mill hourly marginal fuel and purchased power costs (including opportunity costs from lost exports), plus administrative charges and mill rates to cover variable O&M, variable capital expenditures and a contribution to capital investments and long-term O&M. The load would be entirely interruptible, and the utility committed to excluding the mill’s load from its planning and commitment decisions (Nova Scotia Utility and Review Board, 2012).

The determination of Nova Scotia Power’s hourly marginal costs proved to be more difficult than expected.<sup>203</sup> Nonetheless, the rate design succeeded in attracting the investment necessary to restart and retain the mill as an employer while producing some contribution to Nova Scotia Power’s embedded costs. The load retention tariff expires in 2020, at which time the mill may switch to a firm rate or negotiate a new load retention tariff.<sup>204</sup>

### Chelan County Public Utility District Bitcoin Rate

The creation of bitcoin cryptocurrency units requires energy-intensive mathematical computations called mining. To limit the cost of their operations, bitcoin “miners” have sought locations with low-priced electricity. Those operations

plants with long commitment horizons (Rudkevich, Hornby and Luckow, 2014).

204 The Nova Scotia Power system will operate differently after 2020, when it is expected to have access to large amounts of Newfoundland hydro energy and operate under stricter carbon emissions standards. Any new load retention tariff would need to reflect those changes.

typically require very large amounts of power but have few on-site employees and little local economic benefit. One of these locations is Chelan County in Washington state, where the local public utility district owns two very large dams on the Columbia River and has industrial rates about one-fourth of the national average.<sup>205</sup>

Chelan County Public Utility District's existing low-cost resource is fully obligated to a combination of local retail use and long-term contract sales. The contract sales prices are above the average retail rates, bringing significant revenue to fund public infrastructure in the county, including a world-class parks network. When the district received applications for service from bitcoin miners, it decided that this high-density load growth would not be in the public interest,

declared a moratorium on new connections and developed a tariff designed to ensure that any growth of this type of load would not adversely affect other consumers or the local economy (Chelan County Public Utility District, 2018). This tariff is geographically differentiated, to recognize areas where transmission and distribution capacity are available, and includes:

- Payment in a one-time charge of transmission and distribution system costs to serve large new loads.
- A price for electricity, tied to (generally higher) regional wholesale market prices, not Chelan County Public Utility District system costs.
- Severe penalties for excess usage that could threaten system reliability.

---

<sup>205</sup> The Chelan County Public Utility District rate for primary industrial customers up to 5 MWs with an 80% load factor is 1.91 cents per kWh (Chelan County Public Utility District, n.d.). The average U.S. industrial

price was 6.88 cents per kWh in 2017 (U.S. Energy Information Administration, 2018, Table 5.c).



## 17. Future of Embedded Cost Allocation

Change is inevitable as the electric industry adapts to new technology. Part III of this manual, on embedded cost of service studies, has attempted to address many common situations the cost analyst will face in determining an equitable allocation of costs among customer classes. But new technologies and changing loads will dictate new issues and perhaps new methods.

Historically, power has flowed from central generators, through transmission, to primary distribution and then secondary distribution. Customers served at the transmission level have not paid for distribution, and those served at primary have not paid for line transformers or secondary lines. This situation is beginning to change. In some places, the development of distributed solar capacity already causes power to flow from secondary to primary and even onto the transmission system. At some point, all customers may receive service through all levels of the delivery system, requiring a substantial rethinking of the allocation of distribution costs.

In addition to the increased complexity of system operations, utilities have more data about system operations and

customer loads than they had a few decades ago. As the costs of electronics decline, more data will become available to more utilities. Thus, methods that were the best available in the 1980s can now (or soon) be superseded by more accurate and realistic allocations. Computations that would have been unwieldy on the computers of the 1980s are trivial today.

For example, as utilities acquire data on the hourly load of each class, many costs can be allocated on an hourly basis, rather than on such summary values as annual energy use and contribution to a few peak load hours. The costs of baseload generation resources (nuclear, biomass, geothermal) may be assigned to all hours; costs of wind and solar resources to the hours they provide service; storage to the hours in which it exports energy and provides other benefits;<sup>206</sup> and demand response costs to the hours these resources are deployed or the hours in which they reduce costs by supplying operating reserves. In a sense, this is an evolution and refinement of the base-intermediate-peak traditional method, described in Section 9.1.

To illustrate this approach, Figure 45 provides a day's

Figure 45. Daily dispatch for illustrative hourly allocation example

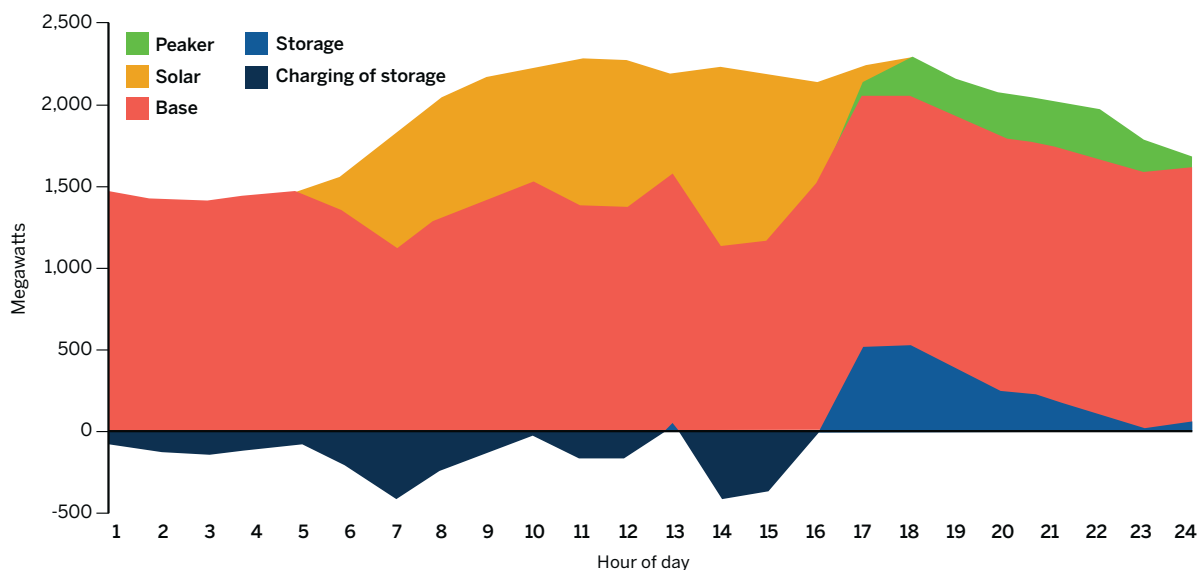

206 Among other things, charging storage in hours with low net loads will raise minimum load levels and reduce ramp rates, benefiting the hours in which net load rises rapidly.

Figure 46. Class loads for illustrative hourly allocation example

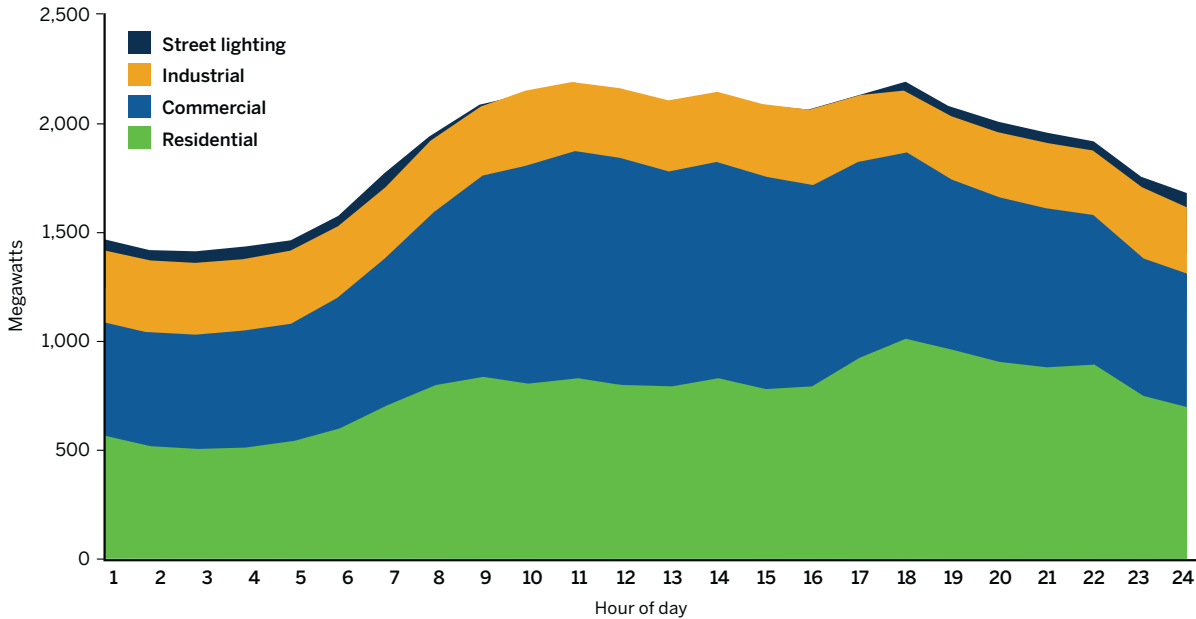

worth of hourly dispatch of four resources: a baseload resource (perhaps nuclear), solar, a peaker (perhaps a combustion turbine) and storage (both as charging load below the axis and generation above the line). In this example, the storage charges from excess base capacity in the early morning and then from solar, and discharges in the evening to replace the waning solar. The actual application of hourly allocation would include 8,760 hours from an actual or typical year, with a wide range of load levels, availability of the base resource and solar output patterns.

Figure 46 provides hourly energy requirements by class (including losses) for the same day as in Figure 45.

Table 39 on the next page provides two types of data from Figure 45 and Figure 46: each class’s share of the load in each hour, and the portion of each resource’s daily generation that occurs in the hour.

The generation cost allocation for a class would be:

$$\sum_{r,h} L_h \times S_{r,h} \times C_r$$

Where  $L_h$  = class share of load in hour  $h$

$S_{r,h}$  = share of resource  $r$  output that occurred in hour  $h$

$C_r$  = cost of resource (in this example, for the day)

Table 40 shows the result of this computation for the data in Table 39. The lighting class, for example, would pay for 1.8% of the base resource, 2.2% of the peakers and just 0.6% of the solar. Table 40 also shows each class’s share of total load, for reference.

**Table 39. Hourly class load share and resource output**

Hour	Class share of load				Resource output: Percentage occurring by hour			
	Residential	Commercial	Industrial	Street lighting	Base	Peaking	Solar	Storage
1	39.0%	35.3%	22.5%	3.2%	4%	0%	0%	0%
2	37.0%	36.2%	23.5%	3.3%	4%	0%	0%	0%
3	36.4%	36.7%	23.5%	3.4%	4%	0%	0%	0%
4	36.7%	37.0%	23.1%	3.3%	4%	0%	0%	0%
5	37.5%	36.6%	22.7%	3.2%	4%	0%	0%	0%
6	38.4%	37.2%	21.4%	3.0%	4%	0%	3%	0%
7	39.7%	37.1%	20.6%	2.6%	4%	0%	8%	0%
8	39.8%	39.2%	19.5%	1.6%	4%	0%	9%	0%
9	38.8%	42.6%	18.4%	0.2%	4%	0%	9%	0%
10	36.7%	44.8%	18.2%	0.2%	4%	0%	8%	0%
11	36.6%	45.1%	18.1%	0.2%	4%	0%	11%	0%
12	35.9%	45.8%	18.1%	0.2%	4%	0%	10%	0%
13	36.7%	44.8%	18.3%	0.2%	4%	0%	7%	1%
14	37.5%	44.0%	18.2%	0.2%	4%	0%	13%	0%
15	36.3%	44.7%	18.8%	0.2%	4%	0%	12%	0%
16	37.4%	43.5%	18.8%	0.2%	4%	0%	7%	0%
17	41.5%	40.6%	17.4%	0.4%	4%	5%	1%	25%
18	44.7%	37.3%	16.1%	2.0%	4%	13%	0%	25%
19	45.2%	35.8%	16.8%	2.2%	4%	13%	0%	18%
20	44.2%	36.1%	17.4%	2.3%	4%	15%	0%	12%
21	44.4%	35.4%	17.8%	2.3%	4%	15%	0%	10%
22	45.9%	33.8%	17.9%	2.4%	4%	19%	0%	5%
23	42.8%	35.1%	19.4%	2.6%	4%	12%	0%	1%
24	41.6%	35.5%	20.1%	2.8%	4%	6%	0%	3%
<b>All hours</b>	<b>39.7%</b>	<b>39.6%</b>	<b>19.1%</b>	<b>1.6%</b>	<b>100%</b>	<b>100%</b>	<b>100%</b>	<b>100%</b>

Note: Percentages may not add up to 100 because of rounding.

**Table 40. Class shares of resource cost responsibilities and load**

	Residential	Secondary commercial	Primary industrial	Street lighting
<b>Resource type</b>				
Base	39.6%	39.2%	19.4%	1.8%
Peaker	44.3%	35.8%	17.7%	2.2%
Solar	37.5%	43.1%	18.7%	0.6%
Storage	43.8%	37.4%	17.2%	1.7%
<b>Class share of total load</b>	<b>39.7%</b>	<b>39.6%</b>	<b>19.1%</b>	<b>1.6%</b>

## Works Cited in Part III

Arkansas Public Service Commission. (2013, December 30). Docket No. 13-028-U, Order No. 21 in general rate case for Entergy Arkansas. Retrieved from [http://www.apscservices.info/pdf/13/13-028-U\\_431\\_1.pdf](http://www.apscservices.info/pdf/13/13-028-U_431_1.pdf)

Barrett, L. (2012, March 29). Nova Scotia-located coal plants next to go. *Australia's Mining Monthly*. Retrieved from <https://www.miningmonthly.com/archive/news/1300953/nova-scotia-located-coal-plants>

BC Hydro. (2014, June 19). *2015 rate design application (RDA): Cost of service (COS) methodology review* [Presentation]. Retrieved from <http://www.bchydro.com/content/dam/BCHydro/customer-portal/documents/corporate/regulatory-planning-documents/regulatory-matters/cos-methodology-review-workshop-presentation.PDF>

Behnke, M., Erdman, W., Horgan, S., Dawson, D., Feero, W., Soudi, F., et al. (2005). *Secondary network distribution systems background and issues related to the interconnection of distributed resources* (NREL/TP-560-38079). Golden, CO: National Renewable Energy Laboratory. Retrieved from <https://www.nrel.gov/docs/fy05osti/38079.pdf>

Bonbright, J. (1961). *Principles of public utility rates*. New York, NY: Columbia University Press.

Bonneville Power Administration. (n.d.). *Current power rates* [Webpage]. Retrieved from <https://www.bpa.gov/Finance/RateInformation/Pages/Current-Power-Rates.aspx>

Burbank Water and Power. (n.d.). *BWP free WiFi* [Webpage]. Retrieved from <https://www.burbankwaterandpower.com/bwp-free-wifi>

Burlington Electric Department. (2019, February 1). *Rates & fees* [Webpage]. Retrieved from <https://www.burlingtonelectric.com/rates-fees>

California Energy Commission. (2014, May 21). *California transmission lines – substations enlargement maps*. Retrieved from [https://ww2.energy.ca.gov/maps/infrastructure/3part\\_enlargements.html](https://ww2.energy.ca.gov/maps/infrastructure/3part_enlargements.html)

California Public Utilities Commission. (2007, July 12). *Opinion addressing electric and gas residential line extension allowance calculation methodology*. Application No. 05-09-019 et al., Decision No. 07-07-019. Retrieved from [http://docs.cpuc.ca.gov/PublishedDocs/WORD\\_PDF/FINAL\\_DECISION/70109.PDF](http://docs.cpuc.ca.gov/PublishedDocs/WORD_PDF/FINAL_DECISION/70109.PDF)

California Public Utilities Commission. (2014, December 18). *Decision regarding smartmeter opt-out provisions*. Application No. 11-03-014 et al., Decision No. 14-12-078. Retrieved from <http://docs.cpuc.ca.gov/PublishedDocs/Published/G000/M143/K904/143904205.PDF>

Chelan County Public Utility District. (n.d.). *Rates and policies* [Webpage]. Retrieved from <https://www.chelanpud.org/my-pud-services/rates-and-policies>

Chelan County Public Utility District. (2018, November 5). *Cryptocurrency rate: Board preview of Nov. 7 public information meeting* [Presentation]. Retrieved from <https://www.chelanpud.org/docs/default-source/default-document-library/nov-5-board-preview-of-nov-7-info-meeting.pdf>

Chernick, P. (2010, August 20). Rebuttal testimony on behalf of the Office of the People's Counsel. Maryland Public Service Commission Case No. 9230.

Chernick, P., and Meyer, M. (1982). Capacity/energy classifications and allocations for generation and transmission plant. *Award Papers in Public Utility Economics and Regulation*. East Lansing, MI: Michigan State University, Institute for Public Utilities.

Colorado Public Utilities Commission. (2018, June 15). Proceeding No. 17AL-0477E, Decision No. C18-0445 in rate case for Black Hills/Colorado Electric Utility Co. Retrieved from [https://www.dora.state.co.us/pls/efi/EFI\\_Search\\_UI.Show\\_Decision?p\\_session\\_id=&p\\_dec=25270](https://www.dora.state.co.us/pls/efi/EFI_Search_UI.Show_Decision?p_session_id=&p_dec=25270)

Coyle, E. (1982, June 24). Average and excess demand once again. *Public Utilities Fortnightly*.

Delmarva Power & Light. (2016, August 15). Response to the Office of the People's Counsel data request 5-11, Attachment D. Maryland Public Service Commission Case No. 9424.

Drazen, M. and Mikkelsen, R. (2013, December 2). Rebuttal evidence on behalf of the Industrial Group. Nova Scotia Utility and Review Board NSPI-P-892/Matter No. M05473, Exhibit N-28. Retrieved from <https://uarb.novascotia.ca/fmi/webd/UARB15>

Electric Reliability Council of Texas. (2018). *2017 ERCOT hourly load data* [Data set]. Retrieved from [http://www.ercot.com/gridinfo/load/load\\_hist/](http://www.ercot.com/gridinfo/load/load_hist/)

El Paso Electric Co. (2015, October 29). *El Paso Electric Company's response to Office of Public Utility Counsel's fifth request for information*. Public Utility Commission of Texas Docket No. 44941. Retrieved from <http://interchange.puc.texas.gov/Search/Documents?controlNumber=44941&itemNumber=215>

Energy and Environmental Economics. (2014). *California transportation electrification assessment — Phase 2: Grid impacts*. San Francisco, CA: Author. Retrieved from [http://www.caletc.com/wp-content/uploads/2016/08/CalETC\\_TEA\\_Phase\\_2\\_Final\\_10-23-14.pdf](http://www.caletc.com/wp-content/uploads/2016/08/CalETC_TEA_Phase_2_Final_10-23-14.pdf)

ENGIE Resources (n.d.). *Historical data reports* [Webpage]. Retrieved from <https://www.engieresources.com/historical-data>

Entergy Corp. (n.d.). *How we trim trees* [Webpage]. Retrieved from [https://www.entergy.com/tree\\_trimming\\_how/](https://www.entergy.com/tree_trimming_how/)

Fang, C. (2017, January 20). Direct testimony on behalf of San Diego Gas & Electric. California Public Utilities Commission Application No. 17-01-020. Retrieved from <https://www.sdge.com/regulatory-filing/20491/application-sdgc-authority-implement-priority-review-and-standard-review>

Federal Energy Regulatory Commission. (n.d.). *Form 1 — electric utility annual report* [Database]. Retrieved from <https://www.ferc.gov/docs-filing/forms/form-1/data.asp>

Federal Energy Regulatory Commission. (2008, April 21). *Opinion and order on initial decision*. 123 FERC ¶ 61,047. Docket No. EL05-19-002, Opinion No. 501. Retrieved from <https://www.ferc.gov/whats-new/comm-meet/2008/041708/E-7.pdf>

Federal Energy Regulatory Commission. (2011, July 21). *Transmission planning and cost allocation by transmission owning and operating public utilities*. 136 FERC ¶ 61,051. Docket No. RM10-23-000, Order No. 1000. Retrieved from <https://www.ferc.gov/whats-new/comm-meet/2011/072111/E-6.pdf>

Gorman, H. (2018, November 15). Testimony on behalf of National Grid. Massachusetts Department of Public Utilities Docket No. 18-150. Retrieved from <https://fileservice.eea.comacloud.net/FileService.Api/file/FileRoom/10043215>

Green Mountain Power. (2016, April 1). *Electric service extensions and relocations*. Retrieved from <http://greenmountainpower.com/wp-content/uploads/2017/01/Line-Extension-Rules-Regulations-4.1.16.pdf>

Hammer, N. (2018, May 30). Direct testimony on behalf of MidAmerican Energy Co. Iowa Utilities Board Docket No. RPU-2018-0003. Retrieved from <https://efs.iowa.gov/efs/ShowDocketSummary.do?docketNumber=RPU-2018-0003>

Henry, T. (2012, October 31). *Luminant coal units get permission to mothball this winter*. National Public Radio. Retrieved from <https://stateimpact.npr.org/texas/2012/10/31/luminant-coal-units-get-go-ahead-to-mothball-this-winter/>

Illinois Commerce Commission. (2008, September 10). Docket No. 07-0566, order in rate case for Commonwealth Edison Co. Retrieved from <https://www.icc.illinois.gov/docket/files.aspx?no=07-0566&docId=128596>

Institute for Energy Economics and Financial Analysis. (2019, March 4). *Owners say Gibbons Creek coal plant in Texas will remain in mothball status*. Retrieved from <http://ieefa.org/owners-say-gibbons-creek-coal-plant-in-texas-will-remain-in-mothball-status/>

Johnson, B. (1980, December 4). Cost allocations: Limits, problems and alternatives. *Public Utilities Fortnightly*.

Kahn, E. (1988). *Electric utility planning and regulation*. Washington, DC: American Council for an Energy-Efficient Economy.

La Capra, R. (1992). Direct testimony on behalf of Boston Edison. Massachusetts Department of Public Utilities Docket No. 92-92.

Lazar, J., and Baldwin, X. (2011). *Valuing the contribution of energy efficiency to avoided marginal line losses and reserve requirements*. Montpelier, VT: Regulatory Assistance Project. Retrieved from <https://www.raonline.org/knowledge-center/valuing-the-contribution-of-energy-efficiency-to-avoided-marginal-line-losses-and-reserve-requirements/>

Lazard. (2018). *Lazard's levelized cost of energy analysis — Version 12.0*. Retrieved from <https://www.lazard.com/media/450784/lazards-levelized-cost-of-energy-version-120-vfinal.pdf>

Levin, A. (2017, June 30). Prefiled response testimony on behalf of NW Energy Coalition, Renewable Northwest and Natural Resources Defense Council in rate case for Puget Sound Energy. Washington Utilities and Transportation Commission Docket No. UE-170033. Retrieved from [https://www.utc.wa.gov/\\_layouts/15/CasesPublicWebsite/GetDocument.aspx?docID=2309&year=2017&docketNumber=170033](https://www.utc.wa.gov/_layouts/15/CasesPublicWebsite/GetDocument.aspx?docID=2309&year=2017&docketNumber=170033)

Manitoba Hydro. (2015). *Cost of service methodology review*. Retrieved from [https://www.hydro.mb.ca/regulatory\\_affairs/pdf/electric/cost\\_of\\_service\\_study\\_submission/appendix\\_3\\_1\\_pcross14.pdf](https://www.hydro.mb.ca/regulatory_affairs/pdf/electric/cost_of_service_study_submission/appendix_3_1_pcross14.pdf)

Manitoba Public Utility Board (2016, December 20). *Order in respect of a review of Manitoba Hydro's cost of service study methodology*. Order No. 164/16. Retrieved from <http://www.pubmanitoba.ca/v1/pdf/16hydro/164-16.pdf>

Marcus, W. (1987). Testimony on behalf of Alberta Federation of Rural Electrification Associations and Alberta Association of Municipal Districts and Counties. Alberta Public Utilities Board 1987 Electric Energy Marketing Agency adjustment.

Massachusetts Department of Public Utilities. (1989). Docket No. 88-250, order in rate case for Western Massachusetts Electric Co.

Meyer, M. (1981, December 17). Clarifying NARUC demand allocation methods. *Public Utilities Fortnightly*.

Michigan Public Service Commission. (2017, July 31). Case No. U-18124, order in natural gas rate case for Consumers Energy Co. Retrieved from <https://mi-psc.force.com/sfc/servlet.shepherd/version/download/068t000001UUAgAAO>

Midcontinent Independent System Operator. (2018). *Planning year 2019-2020 loss of load expectation study report*. Carmel, IN: Author. Retrieved from <https://cdn.misoenergy.org/2019%20LOLE%20Study%20Report285051.pdf>

Minnesota Power. (2013, May 28). *Minnesota Power construction guide: Home edition*. Retrieved from <https://mnpower.com/Content/Documents/CustomerService/ConstructionCenter/residential-construction-guide-with-toc.pdf>

Minnesota Public Utilities Commission. (2016, June 3). Docket No. G-008/GR-15-424, order in natural gas rate case for CenterPoint Energy. Retrieved from <https://www.edockets.state.mn.us/EFiling/edockets/searchDocuments.do?method=showPop&documentId={92AB0946-4F77-4A70-BF38-7D36F88AC979}&documentTitle=20166-121975-01>

Monitoring Analytics. (2014). *2013 state of the market report for PJM*. Eagleville, PA: Author. Retrieved from [http://www.monitoringanalytics.com/reports/PJM\\_State\\_of\\_the\\_Market/2013.shtml](http://www.monitoringanalytics.com/reports/PJM_State_of_the_Market/2013.shtml)

Monitoring Analytics. (2019). *2018 state of the market report for PJM*. Eagleville, PA: Author. Retrieved from [http://www.monitoringanalytics.com/reports/PJM\\_State\\_of\\_the\\_Market/2018.shtml](http://www.monitoringanalytics.com/reports/PJM_State_of_the_Market/2018.shtml)

National Association of Regulatory Utility Commissioners. (1989). *Gas distribution rate design manual*. Washington, DC: Author. Retrieved from <http://documents.dps.ny.gov/public/Common/ViewDoc.aspx?DocRefId=%7B04381803-1D3A-4CD7-BBE3-64EDB16835C0%7D>

National Association of Regulatory Utility Commissioners. (1992). *Electric utility cost allocation manual*. Washington, DC: Author. Retrieved from <https://pubs.naruc.org/pub/53A3986F-2354-D714-51BD-23412BCFEDFD>

Newfoundland and Labrador Hydro (2018). *2018 cost of service methodology review report*. Retrieved from <http://www.pub.nf.ca/applications/NLH2018CostofService/application/Application%20-%20Cost%20of%20Service%20Methodology%20-%202018-11-15.PDF>

Northern Indiana Public Service Co. (2018). *2018 integrated resource plan executive summary*. Retrieved from <https://www.nipsco.com/docs/librariesprovider11/rates-and-tariffs/irp/irp-executive-summary.pdf>

Northern States Power Co.-Minnesota. (2010, November 3). *General rules and regulations*. Retrieved from [https://www.xcelenergy.com/staticfiles/xe/PDF/Regulatory/Me\\_Section\\_6.pdf](https://www.xcelenergy.com/staticfiles/xe/PDF/Regulatory/Me_Section_6.pdf)

Nova Scotia Power. (2013a, June 28). *2013 Nova Scotia Power cost of service study*. Nova Scotia Utility and Review Board Matter No. M05473, Exhibit N-1. Retrieved from <https://uarb.novascotia.ca/fmi/webd/UARB15>

Nova Scotia Power. (2013b, September 12). *2013 Nova Scotia Power cost of service study: Attachment 1 in response to IR-15*. Nova Scotia Utility and Review Board Matter No. M05473, Exhibit N-3(i). Retrieved from <https://uarb.novascotia.ca/fmi/webd/UARB15>

Nova Scotia Utility and Review Board. (1995, September 22). Docket No. NSPI864, order in generic hearing respecting cost of service and rate design for Nova Scotia Power.

Nova Scotia Utility and Review Board. (2012, August 20). Matter No. M04862, decision approving with conditions a load retention rate mechanism. Retrieved from <https://uarb.novascotia.ca/fmi/webd/UARB15>

Nova Scotia Utility and Review Board. (2014, March 11). Matter No. M05473, decision approving amended 2013 Nova Scotia Power cost of service study. Retrieved from <https://uarb.novascotia.ca/fmi/webd/UARB15>

NV Energy. (n.d.). *IS-2 interruptible irrigation service* [Webpage]. Retrieved from <https://www.nvenergy.com/account-services/energy-pricing-plans/is-2>

Otter Tail Power Co. (2017, July 21). *Tariff schedules applicable to electric service of Otter Tail Power Company*. Retrieved from [https://www.otpc.com/media/1300/mn\\_indexandgeneralrulesandregulations.pdf](https://www.otpc.com/media/1300/mn_indexandgeneralrulesandregulations.pdf)

Parmesano, H., Rankin, W., Nieto, A., and Irastorza, V. (2004). *Classification and allocation methods for generation and transmission in cost-of-service studies*. Los Angeles, CA: National Economic Research Associates.

Retrieved from <https://www.nera.com/content/dam/nera/publications/archive1/final%20report%20to%20PUB-MH-NERA-20040401-1.pdf>

Patton, D., LeeVanSchaick, P., and Chen, J. (2017). *2016 assessment of the ISO New England electricity markets*.

Fairfax, VA: Potomac Economics. Retrieved from <https://www.iso-ne.com/static-assets/documents/2017/08/iso-ne-2016-som-report-full-report-final.pdf>

Patton, D., LeeVanSchaick, P., Chen, J., and Palavadi Naga, R. (2018). *2017 state of the market report for the New York ISO markets*.

Fairfax, VA: Potomac Economics. Retrieved from [https://www.potomaceconomics.com/wp-content/uploads/2018/06/NYISO-2017-SOM-Report-5-07-2018\\_final.pdf](https://www.potomaceconomics.com/wp-content/uploads/2018/06/NYISO-2017-SOM-Report-5-07-2018_final.pdf)

Peppin, M. (2013, November 4). Direct testimony on behalf of Northern States Power Co.-Minnesota. Minnesota

Public Utilities Commission Docket No. E002/GR-13-868, Document No. 20311-93284-02. Retrieved from <https://www.edockets.state.mn.us/EFiling/edockets/searchDocuments.do?method=showPop&documentId={21D30B7C-A614-4649-AEE7-CDA29BD1192B}&documentTitle=201311-93284-02>

Public Service Company of Colorado. (2018, December 3). *Rules and regulations: Electric service distribution*

*extension policy*. Retrieved from <https://www.xcelenergy.com/staticfiles/xe-responsive/Company/Rates%20&%20Regulations/18AL-0852E-AL-1785-E-Distribution-Extension-Policy-Tariffs-FINAL.pdf>

Public Utility Commission of Texas. (2000, November 22). *Interim order establishing generic customer classification*

*and rate design*. Docket No. 22344, Order No. 40. Retrieved from <http://interchange.puc.texas.gov/Search/Documents?controlNumber=22344&itemNumber=655>

Public Utility Commission of Texas. (2015, December 18). Docket No. 43695, order in rate case for Southwestern

Public Service Co. Retrieved from [http://interchange.puc.texas.gov/Documents/43695\\_1018\\_876737.PDF](http://interchange.puc.texas.gov/Documents/43695_1018_876737.PDF)

Public Utility Commission of Texas. (2018, March 19). Docket No. 46449, order on rehearing in

rate case for Southwestern Electric Power Co. Retrieved from [http://interchange.puc.texas.gov/Documents/46449\\_825\\_973078.PDF](http://interchange.puc.texas.gov/Documents/46449_825_973078.PDF)

Rea, C. (2013, May 17). Testimony on behalf of MidAmerican Energy Co. Iowa Utilities Board Docket No. RPU-2013-

0004. Retrieved from <https://efs.iowa.gov/cs/groups/external/documents/docket/mdaw/mtgy/~edisp/182629.pdf>

Rudkevich, A., Hornby, R., and Luckow, P. (2014, February 28). *Audit of Port Hawkesbury paper load retention tariff*.

Synapse Energy Economics and Newton Energy Group. Nova Scotia Utility and Review Board Matter No. M05803, Exhibit N-4. Retrieved from <https://uarb.novascotia.ca/fmi/webd/UARB15>

Seattle Municipal Archives. (1977, September 27). *Utilities Committee meeting* (Record Series 4601-03, Event ID

6544) [Audio recording]. Retrieved from <https://www.seattle.gov/cityarchives/exhibits-and-education/seattle-voices/energy-conservation>

Seelye, W. (2016, November 23). Direct testimony on behalf of Kentucky Utilities Co. Kentucky Public Service

Commission Case No. 2016-00370. Retrieved from [https://psc.ky.gov/pscecf/2016-00370/derek.rahn%40lge-ku.com/11232016073202/10\\_-\\_KU\\_Testimony\\_and\\_Exhibits\\_-\\_Malloy\\_to\\_Spanos\\_-\\_FINAL.pdf](https://psc.ky.gov/pscecf/2016-00370/derek.rahn%40lge-ku.com/11232016073202/10_-_KU_Testimony_and_Exhibits_-_Malloy_to_Spanos_-_FINAL.pdf)

Sterzinger, G. (1981, July 2). The customer charge and problems of double allocation of costs.

*Public Utilities Fortnightly*.



Steward, J. (2014). Direct testimony on behalf of Rocky Mountain Power. Utah Public Service Commission Docket No. 13-035-184. Retrieved from <https://pscdocs.utah.gov/electric/13docs/13035184/249702ExJJDirTestSteward1-3-2014.pdf>

U.S. Energy Information Administration. (n.d.-a). *Annual electric power industry report, Form EIA-861: 2001* [Data file]. Retrieved from <https://www.eia.gov/electricity/data/eia861>

U.S. Energy Information Administration. (n.d.-b). *Form EIA-861M sales and revenue: 1990-current* [Data file]. Retrieved from <https://www.eia.gov/electricity/data/eia861m/>

U.S. Energy Information Administration. (1992). *Form EIA-860A: 1990* [Data file]. Retrieved from <https://www.eia.gov/electricity/data/eia860/>

U.S. Energy Information Administration. (2018, October 12). *Electric sales, revenue, and average price*. Retrieved from [https://www.eia.gov/electricity/sales\\_revenue\\_price/](https://www.eia.gov/electricity/sales_revenue_price/)

Utah Public Service Commission. (1999, March 4). Docket No. 97-035-01, report and order in investigation into the reasonableness of rates and charges of PacifiCorp. Retrieved from [www.utilityregulation.com/content/orders/99UT9703501r.pdf](http://www.utilityregulation.com/content/orders/99UT9703501r.pdf)

Washington Utilities and Transportation Commission. (1981). Cause U-81-41, sixth supplemental order in rate case for Puget Sound Power and Light Co.

Washington Utilities and Transportation Commission. (1993, August 16). Docket No. UE-920499, ninth supplemental order on rate design issues.

Xcel Energy. (2018, October 2-4). *Leading the energy future* [Presentation at the Wolfe Research Conference]. Retrieved from [investors.xcelenergy.com/file/4025308/Index?KeyFile=1500113448](http://investors.xcelenergy.com/file/4025308/Index?KeyFile=1500113448)

# **Part IV: Marginal Cost of Service Studies**

## 18. Theory of Marginal Cost Allocation and Pricing

The fundamental principle of marginal cost pricing is that economic efficiency is served when prices reflect current or future costs — that is, the true value of the resources being used to serve customers' loads — rather than historical embedded costs. This is a strong underpinning that most analysts agree on, but there are serious theoretical and computational complications associated with the development of marginal costs.

Marginal cost studies start from a similar functionalization as embedded cost studies: generation, transmission, distribution. However, the data used are not at all the same as those used in an embedded cost of service study. The typical marginal cost of service study requires detailed hourly data on loads by customer class, marginal energy costs and measures of system reliability (loss-of-energy expectation, peak capacity allocation factor, probability of peak, etc.), as well as multiyear data on loads and investments for the transmission and distribution system.

As will be discussed below with specific examples and applications, the time horizon of marginal cost studies and even of individual components within studies can vary. Marginal costs can be measured in:

- The short run, as with energy costs measured for one to three years, and all capital assets kept constant.
- Intermediate periods ranging from six years (the length of two typical general rate cases for many utilities) to 15 years (often used for analysis of T&D capital investments).
- The long term, such as with **long-run incremental costs** for the entire generation function; long-run generation capacity costs based on equilibrium conditions; and the rental of customer equipment in some marginal customer cost studies. The longest possible analysis would be a total service long-run incremental cost study where an optimal system is costed out.

Economic efficiency is served when prices reflect the true value of the resources being used to serve customers' loads.

At one extreme, a true short-run marginal cost study will measure only a tiny fraction of the cost of service that varies from hour to hour with usage and holds all other aspects of the system constant. At the other extreme, a TSLRIC study measures the cost of replacing today's power system with a new optimally designed and sized system that uses the newest technology. In between is a range of alternatives, many of which have been used in states like Maine, New York, Montana, Oregon and California to determine revenue allocation among classes. The major conceptual issue in these studies is using very short-run metrics for energy cost and longer-term metrics for capital costs (generation, transmission and distribution capacity and customer connection costs). Many studies use these mixed time horizons, but this is an error that should be avoided.

Marginal cost pricing generally is not connected to the utility's revenue requirement, except to some extent in restructured generation markets (where the costs are not subject to traditional cost of service regulation). The calculated marginal costs may be greater or less than the allowed revenue requirement, which is normally computed on an accounting or embedded cost basis. It is only happenstance if marginal costs and embedded costs produce the same revenue.

There is also no necessary connection between marginal cost pricing and cost allocation. To summarize the material discussed in more depth below, in its simplest hypothetical form, a marginal cost study computes marginal costs for different elements of service, and these are multiplied by the

determinants for each class. This produces a class marginal cost revenue requirement and, when combined with other classes, a system MCRR. This is then reconciled with the allowed revenue requirement to determine revenue allocation by class. This part of this manual provides some examples of marginal cost studies and the revenue allocation resulting from them.

A second important concept related to marginal cost pricing comes from the theory of general equilibrium: If costs are in equilibrium, short-run marginal costs equal long-run marginal costs. That is, to get one more unit from existing resources would require operating resources with high variable costs, at a cost equal to the cost of both building and operating newer, cheaper resources. However, it is hard to apply this theory in practice because developing and quantifying a system in equilibrium is extremely difficult. Until recently, assets tended to be developed in large sizes relative to the utility's overall system needs, rendering equilibrium conditions unlikely. Equilibrium is also impossible in the real world, for three main reasons. First, loads and fuel prices can never be forecast exactly (and often cannot be forecast even closely). Technology also changes, and the use of specific resources ends up changing. Finally, long lead times to construct various resources (particularly large power plants and transmission lines) can exacerbate the consequences of forecasting errors.

As a result, the marginal cost methods used today, such as those developed by National Economic Research Associates (now NERA Economic Consulting) — discussed in considerably more detail throughout Part IV — do not reflect equilibrium conditions. Moreover, with the current configuration of the electric system and changes over time, the trend has been toward overbuilding, so generation marginal cost ends up systematically below average cost, with ramifications for class allocation. In addition, as previously implemented in many jurisdictions, the definitions of marginal cost have mixed short-term and long-term elements in ways that are theoretically inconsistent.

## 18.1 Development of Marginal Cost of Service Studies

The most common method used in jurisdictions relying on marginal costs for allocation purposes was developed by Alfred Kahn and colleagues at NERA in the late 1970s.<sup>207</sup>

The Kahn/NERA method (referred to as the NERA method in this manual because that is the term most analysts and practitioners use) is the predominant method that current marginal cost analysts use. Some entities, such as Oregon, use a long-run marginal cost method for generation, and other states and analysts have proposed changes to specific components of the NERA method. Nevertheless, the NERA method, whatever its benefits and detriments, is the starting point for most current marginal cost of service study analysis, and marginal cost of service study analysts have identified fewer alternative methods than have embedded cost of service study analysts.

Another practical consideration in analyzing marginal cost methods is that very few states are marginal cost jurisdictions. In particular, California, Nevada and Oregon calculate marginal costs for generation and other functions; Maine and New York have deregulated generation but use marginal costs for distribution. Thus, many examples in the remaining discussion come from a relatively small number of jurisdictions.

The NERA methodology uses:

- Long-term customer costs based on the cost of renting new customer connection equipment using the current technology.
- Intermediate-term transmission and shared distribution costs based on an analysis of additions made to serve new capacity but not to increase reliability or replace existing capacity to continue to serve load, measured over 10 to 15 years.
- Generation capacity costs that tend toward a longer term based on new construction.<sup>208</sup>
- Usually relatively short-term marginal energy costs (one to six years).

<sup>207</sup> National Economic Research Associates developed a series of papers on the topic. The most critical for this manual are *A Framework for Marginal Cost-Based Time-Differentiated Pricing in the United States* (1977a) and *How to Quantify Marginal Costs* (1977b).

<sup>208</sup> Some utilities and consumer advocates have used shorter-term generation capacity costs. Consumer advocates often chose shorter-term generation costs when revenue allocation was done by function rather than in total. See Section 19.3.

One of the key concepts developed through this work was the real economic carrying charge. A RECC takes the revenue requirements or costs of a resource and reshapes them to reflect a stream of costs that increases with inflation and has the same present value as the revenue requirements. Inputs to a RECC are the same as those used for utility revenue requirements. They include the capital structure and cost of capital, a discount rate, income tax parameters (rates, depreciation and whether specific tax differences are normalized or flowed through), book depreciable life and costs of property taxes and insurance. The RECC is not unique to this method but can be used in conjunction with other methods, such as long-run incremental cost of generation (see Section 19.1) or total service long-run incremental cost (Section 25.1).

Analytically, the RECC also reflects the value associated with deferring a project from one year to the next and can be used to place projects with different useful lives on a common footing. The RECC is lower than the utility's nominal levelized cost of capital for a given type of plant and lower than the early year revenue requirements calculated traditionally for such a plant. A further discussion of the RECC, with a specific example, is in Appendix B.

The mismatch of long-run and short-run marginal costs among cost components is particularly problematic in the NERA method. If system costs are allocated using the total measurement of generation costs based on relatively low shorter-run costs for energy and generation (that do not consider the value of capital substituting for energy over time) and much longer-term costs for the distribution and customer functions, the study will mathematically give too much weight to distribution costs in a marginal cost study, to the detriment of small customers. Analysts have used a number of methods to ameliorate or counteract this mismatch. These methods are briefly identified here but discussed in more detail in the sections noted.

- Developing a longer time horizon for generation costs (see Chapter 19 and Section 25.1). Various methods include:
  - Extending the time horizon for marginal energy costs and including carbon dioxide reductions and renewable costs as adders to short-run marginal energy costs.

- Using long-run incremental costs, including full costs of new construction of generation.
- Applying the new paradigm of long-run incremental cost analysis, at least for generation, explicitly to include the energy transition to renewables for generation and storage and demand response for capacity.
- Using short-run customer costs based on the direct costs of hooking up new customers as a better match with short-run energy costs (see Chapter 21).
- Ignoring joint and common costs, reducing long-run A&G costs that are assigned to functions other than energy (see Chapter 22).
- Reconciling on a functionalized basis (generation, transmission and distribution by the marginal costs of those functions) instead of on a total cost basis (see Chapter 24).

Another important issue NERA addressed was the method used to reconcile marginal costs to the system revenue requirement. The calculated marginal costs may be greater or less than the allowed revenue requirement, which is normally computed on an accounting or embedded cost basis. Thus, methods such as the equal percent of marginal cost approach are sometimes used for reconciliation, but some analysts prefer to use the **inverse elasticity rule**, where elastic components of usage are priced at the measured marginal cost, while inelastic components of usage are priced higher or lower than marginal cost to absorb the difference between embedded and marginal costs. This issue is discussed further in Chapter 24.

In the NERA method, the functionalization and then classification of system costs as energy-related, demand-related and customer-related is performed, just as in a traditional embedded cost of service study. The marginal cost of each of these elements is then estimated using a wide variety of techniques. These marginal costs are then multiplied by the billing determinants for each class to obtain the marginal cost by class, commonly referred to as the marginal cost revenue requirement. The MCRR is then reconciled to embedded costs and allocated across the classes. Each set of billing determinants used in the calculation is developed on a class

**Table 41. Illustrative example of allocating marginal distribution demand costs by two methods**

	Residential	Small commercial	Medium commercial	Large commercial and industrial
<b>Class coincident peak-based allocation</b>				
Marginal cost per kW	\$100	\$100	\$100	\$98*
Probability of circuit peak (MWs)	5,900	1,000	3,800	1,500
Marginal cost revenue requirement for distribution demand	\$590,000,000	\$100,000,000	\$380,000,000	\$147,000,000
Share of costs	48%	8%	31%	12%
<b>Customer noncoincident peak demand allocation with diversity</b>				
Marginal cost per kW	\$100	\$100	\$100	\$98*
Noncoincident peak demand (MWs)	23,878	3,131	7,482	3,561
Effective demand factor	36%	37%	65%	76%
Noncoincident peak demand multiplied by effective demand (MWs, rounded)	8,600	1,150	4,850	2,700
Marginal cost revenue requirement for distribution demand	\$860,000,000	\$115,000,000	\$485,000,000	\$264,600,000
Share of costs	50%	7%	28%	16%

\*Lower marginal cost of large commercial/industrial reflects lower line losses on primary distribution loads.

Note: Percentages may not add up to 100 because of rounding.

Sources: Southern California Edison. (2017). *Errata to Phase 2 of 2018 General Rate Case: Marginal Cost and Sales Forecast Proposals; 2018 General Rate Case Phase 2 Workpapers*; additional calculations by the authors

basis and, except for the customer-related costs, is divided into time periods and provided for the year as a whole.

For the energy-related costs, the allocation is relatively straightforward, multiplying energy use in each time period by the energy cost in each time period. For the generation capacity costs related to reliability at peak, the allocation typically has not been done using the coincident peak methods most commonly used in embedded cost analysis (and discussed in Section 9.3). Instead, marginal costs are typically allocated over a larger number of hours. This allocation has been done using (1) loss-of-energy expectation,

(2) an allocation factor spread equally over the top few hours (100 to 300)<sup>209</sup> or (3) peak capacity allocation factors, effectively a hybrid between the two other methods.<sup>210</sup>

For transmission and distribution costs, the methodology is not as settled, even among marginal cost jurisdictions. Allocation has been either coincident peak-based (related to the probability of peaks on distribution elements) or noncoincident demand-based, with adjustments for diversity between the load at the customer and load at the circuit or substation transformer (which can be developed through statistical analysis). Table 41 illustrates how the two methods can produce

209 This method was developed in California after restructuring in the late 1990s for use in allocating certain transition costs, because generation was expected to be competitive and loss-of-load probability was expected not to exist in a competitive market. San Diego Gas & Electric used the top 100 hours method for allocation of generation costs until 2012 (Saxe, 2012, Chapter 3, pp. 4-5). The company ultimately switched to loss-of-load expectation in 2014 (Barker, 2014). The top 100 hours are still used for allocation of the remaining transition costs of all the major California utilities.

210 Pacific Gas & Electric uses these. Every hour in excess of 80% of the peak is assigned a contribution to peak based on the load minus 80% of the peak. The mathematics mean that the peak hour has an allocation that is 20 times the allocation of an hour that is 81% of the peak and twice the allocation of an hour that is 90% of the peak. In past cases, the company used the gross load curve for both generation and distribution; in 2016, it switched for generation to the load curve net of wind and solar generation while using gross load for distribution. See Pacific Gas & Electric (2016), chapters 9 and 10.

substantially different outcomes (Southern California Edison, 2017a, 2017b, pp. 59-61 and Appendix B, with additional calculations by the authors).<sup>211</sup> Data from Southern California Edison were used because the company currently employs a hybrid of both methods.

Similar to its use of PCAF for generation allocation, Pacific Gas & Electric (PG&E) uses a PCAF method at the local level (each of its 17 divisions) for distribution costs (Pacific Gas & Electric, 2016, Chapter 10). Nevada uses an hourly allocation method based on probability of peak using the system peak demand from which its costs were calculated (Bohrman, 2013, pp. 3-8).

Analysts must be extremely careful when calculating the MCRR, particularly associated with T&D demand. The reason is that not all kW are the same. Many utilities use one type of kW when developing a marginal cost per kW of demand or capacity (e.g., a kW of substation capacity, where there are 25,000 MWs of such capacity on a utility system) and then multiply the marginal costs by a kW that measures a different type of demand (for example, system peak demand where there are only 15,000 kW of demand). In particular, when the marginal cost is measured based on a larger number of kW than the kW on which the cost is allocated, the result is to assign too few costs as demand-related; this overweights the customer costs in a distribution cost calculation. Additionally, controversy can arrive in measuring the kW of demand for cost allocation. Although there is no hard and fast rule, two examples in Appendix C illustrate the concerns.

## 18.2 Marginal Costs in an Oversized System

T&D systems have tended to be oversized because equipment (transformers, wires, etc.) comes in fixed sizes. Moreover, oversizing could theoretically be cheaper in the long run than having to return to the same site to change out equipment, particularly when underground lines have been installed. Although it may be economically preferable in some circumstances, this oversizing tends to reduce intermediate-term marginal T&D costs below full long-run marginal costs or embedded costs.

Increased marginal costs for T&D do not necessarily

result from high utility rates of return and strong financial incentives for rate base growth, as noted in almost every utility presentation and analyst report, because intermediate-term marginal cost methods usually have not included system replacements, as discussed in Chapter 20 and Appendix D. System replacements and incremental investments to improve safety and reliability (but not to serve new demand) are a large component of new T&D construction by utilities.

Generation is even more complex. Not only was it uneconomic in the past to build generation in small increments, but there were significant benefits of capital substitution (spending money on capital to reduce the use of expensive fuel) that created excess expensive capacity. In the past, when vertically integrated utilities built coal and nuclear plants, they would conduct planning exercises that provided a justification for those projects based on extremely long-term estimates of future fuel costs and future dispatch. As a result, large portions of the investment-related costs of these plants were justified based on savings of costly fuel and purchased power relative to building peaking generation. The forecast relatively high loads and high fuel prices did not always materialize, and long lead times of large projects meant they could not be economically changed or canceled in cases where the forecasts turned out to be wrong. The disconnect between generation construction and short-run marginal costs also resulted in stranded costs when restructuring took place.

A similar phenomenon occurred more recently as investments were made in expensive environmental retrofits of coal plants instead of retiring the units. Some of these investments ended up being uneconomic given lower than expected prices for natural gas and renewables, not to mention the prospect of greenhouse gas regulation.

For a number of utilities, a short-run marginal cost — assuming the existence of these future plants with high capital cost and low-cost fuel — was used to evaluate energy efficiency, renewables and CHP and to design rates. This methodology effectively gives preference to utility resources while depressing the avoided cost paid to independent power producers, finding less energy efficiency to be cost-effective,

<sup>211</sup> Loads are rounded off to the nearest 50 MWs in the table, leaving out small classes and granular detail for ease of exposition.

and lowering incentives for customer-side response through rate design. Examples include Duke Power and Carolina Power and Light Co. from 1982 to 1985, which assumed that future coal and nuclear plants would be built when evaluating PURPA projects (Marcus, 1984, pp. 10-23). Another example is the calculations by Ontario Hydro for evaluation of energy efficiency and private power prior to and during the 1990-1993 demand/supply plan hearings at the Environmental Assessment Board (Marcus, 1988, pp. 14-16). A third, from 1990-1991 hearings, is Manitoba Hydro's analysis of energy efficiency using differential revenue requirement analyses assuming that the Conawapa hydro project would be constructed (Goodman and Marcus, 1990, pp. 132-133, F34-F45). Appendix E provides a mathematical discussion of this issue.<sup>212</sup>

Then, when excess capacity appeared, short-run marginal energy costs declined. The need for generation capacity also declined, although the extent to which that decline was recognized in short-run marginal cost methods varied across jurisdictions (see Section 19.3).

## 18.3 Impact of New Technology on Marginal Cost Analysis

Excess capacity can be the result of other cost transitions made for a combination of economic and environmental reasons — in particular, the transition to renewables and other related technologies (storage) that are not fuel-intensive.

### 18.3.1 Renewable Energy

Low-cost wind and solar resources are being installed to provide economic and environmental benefits and reduce fuel use even where capacity is not needed and in some cases are causing the retirements of older plants.<sup>213</sup> In some instances, the total cost of new renewable generation can be less than the fuel and O&M costs of generation that it displaces.

These resources have already been reducing short-term market prices in virtually all ISOs/RTOs. Short-run energy market prices are even sometimes negative in off-peak hours, due to generation that cannot shut down and restart for the

next peak period and the renewable energy tax credits that make operating some resources profitable even if they need to pay for the market to absorb their energy output.

The renewable transition makes the traditional marginal cost methodology less relevant. Capacity costs and short-run marginal energy costs are low, while embedded costs remain high. Essentially a short-run marginal cost method sends price signals that energy is cheap because the fossil-fueled component of energy is being used less frequently and is becoming less costly when it is used, while generation capacity costs are also low unless artificially increased.

However, while short-run marginal costs are decreasing, embedded system generation costs are remaining at current levels or increasing because additional capacity is being brought on in advance of need. Other effects on utility generation revenue requirements arise because: (1) some renewables acquired relatively early may be relatively expensive compared with newer renewables in the face of declining cost curves; (2) the growth of renewables may be dampening growth in natural gas prices, which makes renewable energy look less cost-effective than it really is; and (3) in some cases, accelerated recovery of costs reflecting the early retirement of fossil-fueled and nuclear generation may raise embedded costs.

### 18.3.2 Other New Technologies

Smart grid resources can also reduce the marginal cost of distribution capacity by extending the ability to optimize the use of existing capacity. This may increase excess capacity in the short term while reducing long-run costs by substituting controls for wires and fuel. Sections 7.1 and 11.5 discuss in detail the technological characteristics of smart grid functions — including integrated volt/VAR (**volt-ampere reactive**) controls, automated switching and balancing of loads across circuits and enablement of demand response programs — and of storage and demand response resources.

In the near term, large-scale battery storage on the utility grid can be an economic substitute for peaking and relatively

<sup>212</sup> Although not strictly a marginal cost issue, divergence between short-run and long-run marginal cost can be one reason for stranded costs (which tend to have been measured against an estimate of short-run cost over time).

<sup>213</sup> An explicit example is Xcel Energy's program of substituting "steel for fuel" by replacing coal and gas with wind and solar generation (Xcel Energy, 2018).



inefficient intermediate gas-fired generation — including generation now receiving reliability-must-run (RMR) contracts in transmission rates — while reducing the cost of ramping to meet daily peak loads (Maloney, 2018; see also California Public Utilities Commission, 2018). This could reduce both marginal energy costs and marginal capacity costs if it proves ultimately to be cheaper than a combustion turbine. In the longer term of a decarbonized system with large amounts of intermittent resources, batteries are likely to need to operate for more hours.

If installed elsewhere on the system, particularly on the distribution system, storage batteries can not only provide support for generation and transmission but remedy distribution overloads or mitigate outages on less reliable radial distribution lines, especially where other smart grid functions are not feasible. The effect would be to reduce marginal capacity costs — although some portion of the cost of the storage should be included as a distribution capacity resource. Behind the meter, storage can provide demand response for the utility as well as significant benefits to customers.

Demand response (e.g., air conditioner cycling, interruptible customers) typically has been used as an emergency capacity resource to avoid bulk generation outages. But it could also be used (when coupled with smart appliances) to mitigate transmission and distribution overloads when the customer is at an appropriate voltage level, reducing future marginal costs.

## 18.4 Summary

The key issues associated with marginal cost analysis on a generic basis are:

- Mixed time horizons. Marginal cost methods often mix short-run, intermediate-term and long-run marginal costs in an inconsistent manner that has tended to have inequitable results over the last 30 years.
- Obsolete technique given changing resource options. Whether short-run or long-run, marginal energy and generation capacity cost allocation methods essentially

**The technology-based economic transition to a smarter grid and a greater role for intermittent and storage resources will change the marginal cost paradigm.**

have been designed for fossil-fueled systems, using economic dispatch. Renewable resources, storage and other resources tend to depress the short-run prices of fossil-fueled energy and existing fossil-fueled capacity.

- Treatment of renewables. With the substitution of renewables (relatively high capital costs but almost zero variable costs) for fossil fuel, short-run marginal energy costs are significantly below the cost of new generation, with significant implications for cost allocation. As an example, a wind plant that runs at 40% to 50% capacity factor (in the Southern Plains) depresses short-run marginal energy cost and may have no impact on capacity costs.
- Availability of storage. Storage is likely to have a lower cost of capacity than fossil-fueled capacity for at least some applications. It also provides more services than conventional peaking capacity depending on where it is sited — for example, it can provide some ancillary services (e.g., fast ramping service) and help with variable renewable energy integration. However, it may have the counterintuitive impact of depressing short-run marginal costs.

In essence, the technology-based economic transition to a smarter grid and a greater role for intermittent and storage resources will ultimately change the marginal cost paradigm from that used for the last four decades while blurring the traditional distinctions among generation, transmission and distribution costs. The short-run marginal cost paradigm based primarily on variable costs of fossil-fueled generation is becoming less central to the fundamental economics of electricity service for which regulation must account. That change has not been fully analyzed within the structure of marginal cost rate-making, but a pathway for such analysis will be discussed in Chapter 25.

## 19. Generation in Marginal Cost of Service Studies

The theory of marginal generation costs starts from the position that electric generation is a joint product, producing energy as well as capacity or reliability. When marginal cost methods were introduced in the 1970s, they constituted a significant advance over the previously used embedded cost theory that assumed that generation capital investment and nondispatch O&M costs are all demand-related and only short-term variable costs are energy-related. The marginal cost paradigm recognizes in some way, albeit imperfectly, that with a variety of generating plant technologies, capital can be substituted for energy and that all capital is not related to the need to serve peak demand.

### 19.1 Long-Run Marginal Cost of Generation

The first key question regarding marginal generation costs is the balance between short-run and long-run marginal costs. There are two options for explicitly calculating long-run marginal costs. Both are based on the cost of building and operating new resources.

The first option is the use of long-run marginal costs (referred to as long-run incremental costs by the entities that developed these methods) to allocate generation costs based on plant types. This method was developed in the Pacific Northwest, where large portions of the systems were energy-constrained. Hydro systems have very flexible capacity but depend on water for energy generation, and the supply of water is both limited under adverse conditions and not controllable. Under this method, the cost of new baseload generation in a resource plan was calculated as the total marginal generation cost. The cost of peaking generation

(usually a combustion turbine) was determined to be the peak cost, and the remaining costs were energy-related.<sup>214</sup> In the past, the baseload generation cost was often a coal plant. This method has recently been modified in Oregon to use a combustion turbine for peak generation and a mix of combined cycle gas generation and wind generation for the nonpeak alternative (Paice, 2013, pp. 7-8).

The second long-run marginal cost option has been used by the California Public Utilities Commission for purposes other than cost allocation and rate design. Energy and Environmental Economics Inc. (E3) developed a relatively sophisticated hourly long-run incremental cost model.<sup>215</sup> The California commission has used the E3 model to evaluate energy efficiency, demand response and distributed generation for a number of years, although it has not yet used it for rate design. The generation components of this method have an evaluation period of up to 30 years. The model is designed to assume the short-run avoided cost until the year when capacity is projected to be needed and the full cost of a combined cycle generator if the long-run base total fossil-fueled generation cost is in equilibrium. The effect of this, in the past three decades, would have been to understate generation marginal costs compared with those that would exist under an equilibrium market. However, if the year of capacity need is set to the current year, which has been done in some recent analyses, the model becomes a full long-run marginal cost model, alleviating this problem.

E3 divides the costs into energy and capacity, with the costs of a simple-cycle combustion turbine (net of profits received for energy and ancillary services) treated as capacity-related and all remaining combined cycle costs as energy-related. The E3 model then shapes the energy costs into an

214 This method is similar to the equivalent peaker method (discussed in Section 9.1), except that it includes both capacity and energy.

215 The description of this method is taken from Horii, Price, Cutter, Ming and Chawla, 2016.

hourly load shape using information on load shapes over time (including changes resulting from renewable resource additions) and adds a projection of line losses, carbon dioxide costs and ancillary services to obtain a market price. To obtain the full marginal or avoided energy cost — to the extent that renewable resources (net of their resource-specific capacity credits) cost more than the energy-related cost of a combined cycle unit — the resulting extra costs of meeting the renewable portfolio standard over the 20-year period are added to the market-based costs.

## 19.2 Short-Run Marginal Energy Costs

Short-run marginal energy costs normally are calculated from a production cost or similar model on a time-differentiated (or even hourly) basis. These calculations are made over a relatively short period (typically one to six years out, depending on the utility). Marginal energy costs in the West — whether simulated directly or simulated through a market pricing version of a production cost model — typically have been dependent on the cost of gas and the overall efficiency of the system (i.e., the percentage of time gas was the incremental fuel, the type of gas plants used and the amount of baseload or intermittent generation available). This changes in very wet months, when hydro may be the marginal resource, or increasingly at midday on light-load days, when solar becomes a market driver. In Texas and the Plains states, wind is increasingly a market-driving resource. For utilities in the Midwest, South and East, the incremental fuel is typically a mix of gas-fired generation during peak and midpeak periods with coal-fired generation off-peak in some locations. Some utilities face much higher marginal costs or market prices in extreme winter weather because of gas price spikes, limits on gas availability, high peak loads and unreliability of service due to freezing of coal piles and some mechanical parts of power plants and gas wells.

In California and Nevada, utilities typically have modeled and averaged marginal energy costs over one or three years, corresponding to the length of time between rate cases, but PG&E uses six years. These very short-run energy analyses, particularly when coupled with long-run generation capacity

cost analyses, tend to overstate the balance of costs for customer classes with lower load factors and understate them for customer classes with higher load factors. The cost of a combustion turbine, which is allocated heavily based on peak conditions, becomes a larger portion of marginal generation costs if short-run energy costs are lower than if higher longer-run costs are used.

It is of key importance that reasonable natural gas price forecasts are used, particularly if looking out beyond a very short time horizon. In much of the country, the modeling outputs are very sensitive to this input factor, and key results can vary greatly depending on the natural gas forecast. The E3 long-run incremental cost forecast uses short-term forecasts from futures and a longer-term mix of forecasts from the U.S. Energy Information Administration and the California Energy Commission's *Integrated Electric Policy Report* (Horii et al., 2016, pp. 5-8). Utilities tend to use their own forecasts, but in California those forecasts are updated after intervenor testimony is filed.

Greenhouse gas emissions are an important marginal cost, but there is not a consensus method to address it. Carbon cost is, in theory, internalized by California's cap-and-trade system, although it becomes difficult to properly model the dispatch in the Western United States when only California resources and California imports carry carbon values. The **Regional Greenhouse Gas Initiative** market performs a similar function in the Northeastern United States. In all jurisdictions where carbon prices are included, carbon prices must be forecast if longer-term marginal cost methods are used. Prices need to be forecast over the full study duration where markets do not exist for these products. Even in California and the Regional Greenhouse Gas Initiative states, market-determined allowance prices extend out for only a three-year period. However, in places where carbon is not explicitly valued, a marginal cost method should include current or future carbon values associated with fossil-fueled generation to provide forward-looking price signals. In jurisdictions covered by electric sector cap-and-trade programs, there are still questions about whether the marginal cost from the program is sufficient or whether another measure, such as the social cost of carbon

or marginal cost of long-term greenhouse gas reductions, is more accurate.

The addition of renewable resources to utility portfolios, especially if added in advance of the need for capacity, depresses marginal energy costs by adding energy with zero fuel costs (or even negative costs in the case of wind energy with the production tax credit). The result is to reduce marginal costs in two ways. It reduces the heat rates of gas-fired generators on the margin. It also decreases the number of hours when a gas-fired resource is on the margin in some places where cheaper coal or surplus hydro (the Pacific Northwest or Canada) can be a marginal source of energy or when renewables are curtailed. In other words, the short-run model reduces energy costs relative to capacity costs when new renewable resources are constructed.

It can be argued that costs of compliance with an RPS are short-run marginal costs, in the sense that if load changes on a permanent basis, a portion of that load must be met with renewable resources. The capital and operating costs of those resources (possibly net of the fixed costs of an equivalent amount of peaking capacity) would replace the market prices and fuel costs from existing generation used to calculate marginal costs.<sup>216</sup> The Nevada utilities first developed calculations using the RPS as an adder to conventional resources in Sierra Pacific Power Co.'s 2010 rate case (Pollard, 2010).<sup>217</sup> The RPS adder was then adopted by California consumer groups (Marcus, 2010b, p. 45) and by Southern California Edison (2014, pp. 31-32). It is also included in the E3 long-run marginal cost model (Horii et al., pp. 36-38). Note that, mathematically, in the Western states that use marginal cost analysis, the RPS adder increases if short-run market energy prices decline (e.g., due to an update that reduces gas prices).

Before deregulation, there was a debate over whether short-run marginal energy costs should be the instantaneous cost in the given hour as envisioned in the original NERA method or should reflect other factors such as unit commitment. Often the actual unit that varies with short-term

variation in loads is a flexible resource, not necessarily the least-cost resource, and the dispatch of hydro can change with changes in load. In California, the utilities commission adopted a method that computed marginal costs as the change in total costs for a large utility between a symmetrical increment of several hundred MWs above and several hundred MWs below current loads in each hour. This resulted in a more expansive definition of short-run marginal costs that included not just the incremental costs of a plant running in a given hour but the differences in how many power plants were committed if the load were different — thus causing changes in costs of startups and plants running at minimum load to be available the next day. These unit commitment costs generally increase the marginal costs experienced during peak hours above hourly marginal costs. In current wholesale markets, unit commitment costs tend to be reflected in day-ahead prices because bidders who need to commit a resource must include that cost in their bids.

Several ancillary services defined by FERC and ISOs/RTOs are purchased on an hourly basis. These include spinning reserves, nonspinning reserves available in a time frame of about 10 minutes, in some cases replacement reserves (plants that could fill another reserve type on a contingency basis if that reserve was used in real time) and frequency regulation (both upward and downward) on a minute-to-minute basis. Additionally, there are services that are not officially called ancillary services but that are related. These include the need to assure that enough generation is committed to meet energy requirements (residual unit commitment, acquired daily) and energy that can be dispatched to ramp upward or downward within a bid period to meet changes in demand and changes in variable (typically renewable) resource output that can be forecast hourly or subhourly (e.g., solar). Finally, there are out-of-market real-time costs necessary to maintain system reliability if generation is not available or if transmission contingencies occur. These costs are “uplift” (charged to system loads) by ISOs/RTOs. That said, uplift costs can be

<sup>216</sup> As an analogy, in most jurisdictions with retail choice, RPS requirements typically are implemented in a way that is a short-run cost. As a percentage requirement based on load served or retail kWh sales, it automatically varies based on kWhs in a predictable way. Therefore, treating RPS requirements similarly in jurisdictions where generation is regulated is appropriate.

<sup>217</sup> Those calculations established the principle, even though they were flawed because they included energy efficiency resources that were cheaper than market prices that could meet Nevada RPS requirements and because the energy efficiency costs did not consider a time value of money (Marcus, 2010c, pp. 7-8).

incurred unnecessarily if ISOs/RTOs fail to optimize existing markets to provide necessary reserves and other ancillary services to provide necessary grid support.

Although some utilities and industrial customers suggest these costs are really capacity costs and thus should be subsumed in the marginal cost of capacity, they are paid for in each hour along with market energy costs, so that, regardless of the semantics, they should be allocated on an hourly basis. The costs are not large in normally functioning markets. For purposes of evaluation of energy efficiency in California, E3 uses a figure of 0.7% of marginal energy costs for ancillary services (Horii et al., pp. 25-26),<sup>218</sup> a decrease from 1% several years ago. A more detailed study of California ISO ancillary services costs for the 12 months ending April 2010 ended up with 0.8% of marginal energy cost, with amounts ranging from 1.17% summer on-peak to 0.61% winter midpeak (Marcus, 2010b, p. 45). Although not large, the costs are real and should be included in a short-run energy costing methodology.

Costs paid on an hourly basis for intrahour ramping may also be incurred. This is particularly an issue in the Western U.S. The drop-off of solar energy as the sun sets plus increasing of loads toward an evening peak can cause a doubling of loads served by other resources (i.e., net loads, excluding wind and solar generation) on some low-load days in the spring and fall. This causes the need to rapidly ramp up conventional generation, such as natural gas and hydro, and opens up an important new role for storage. Any energy costs of ramp should be assigned as a marginal cost to those hours.

### 19.3 Short-Run Marginal Generation Capacity Costs

Under the short-run marginal cost method, the theory, as originally developed in the late 1970s, is that the value of generation capacity is capped at the least cost of acquiring generation for reliability. If all that was needed was capacity, a cheap resource to provide capacity (such as a peaking plant) could be built. Any more expensive generation would have been built specifically to reduce total system costs (fuel plus capacity). Under this method, the cost of the peaker is multiplied by the real economic carrying charge, and O&M and A&G costs are added to it.

A number of technologies could be the least-cost generating capacity option, including:

- Conventional peaking generation, demand response or economic curtailment.
- Midrange generation net of fuel or market price savings.
- Short-term or intermediate-term power purchases.
- Results of RTO capacity market auctions or market prices for capacity procured for resource adequacy (if applicable).
- Centralized or distributed storage net of fuel or market price savings.

In equilibrium, without cheaper short-term options, the cost of a peaker would theoretically equal the shortage value customers experience from generation outages. That is the reason marginal generation costs have typically used a peaker, because they effectively assume equilibrium exists. The California and Nevada utilities other than PG&E use the full cost of a combustion turbine as the basis for marginal capacity costs. PG&E, the California Public Utilities Commission advocacy staff and other consumer intervenors recognize that the short-run marginal cost can be less than a peaker. Lower costs should occur if capacity is either unneeded or so economic that energy savings from construction of baseload generation exceeds the cost of the plant, or if cheaper options than a combustion turbine peaker are available. Theoretically, the marginal generation capacity cost can also be higher for short periods when there are shortages of capacity within the lead time of building generation, but those conditions have not occurred since the early 1980s (California Public Utilities Commission, 1983, pp. 220-222).

In 2017-2018, Southern California Edison claimed that some of the need for system reliability was not caused by peak loads but instead by the requirement to have adequate capacity available to ramp generation from midafternoon to the evening peak in periods of the year with relatively low loads (and relatively high output from conventional hydro plants that reduced their flexibility for use in peaking). Although many options are available to reduce the size and scope of the ramp, particularly storage and use of flexible

---

<sup>218</sup> These costs do not include ramp, residual unit commitment or out-of-market costs.

loads in areas such as water supply and delivery (see Marcus, 2010b, and Lazar, 2016), one of the options the California ISO identified was gas-fired generation. New storage options may be especially well suited for dealing with problems of ramping because of the timing of both charging and discharging batteries or taking other actions like storing hot or chilled water.

Equating a marginal capacity cost based on a peaker with very short-run energy costs creates a mismatch that is detrimental to customers with peakier load shapes. Several points must be considered here.

1. Costs of peakers vary. Smaller combustion turbines and aero-derivative turbines are more expensive than larger combustion turbines. Some of these smaller turbines have costs that approach or even exceed the cost of a larger combined cycle plant.<sup>219</sup> When conducting marginal cost studies, some utilities and industrial customers have requested approval for expensive peakers as marginal capacity costs.<sup>220</sup> However, that point ignores the key finding of the NERA method: that the marginal cost of capacity is the least costly source of capacity, so that by definition the more expensive peaker installed for other reasons is not the marginal cost of capacity under that framework.
2. Financing costs for peakers vary. In California, a number of parties (including E3) have used merchant plant financing, which is more expensive than utility financing, to develop the marginal cost of capacity. Again, the issue is that a merchant plant is not the least costly source of capacity because merchant plants have higher required returns. Furthermore, merchant plants often have off-take contracts that are shorter than the physical life of the plant. Using the shorter contract life for capital recovery also inappropriately increases the marginal cost of generating capacity.
3. Even a peaking power plant would make money in the market (or save fuel and purchased power costs in a vertically integrated utility that is not closely affiliated with

a market). Combustion turbines installed in the 1970s, when the NERA method was developed, had heat rates in the range of 15,000 Btu per kWh and burned expensive diesel oil. They were machines that provided essentially pure capacity — reserves that were turned on to keep the lights from going out. Much of the gas-fired load at that time came from less flexible steam plants with heat rates from 9,000 to 12,000 Btu per kWh. Modern peakers have a heat rate in the range of 10,000 Btu per kWh (or lower) and burn gas. They actually have better heat rates than many of the older intermediate steam plants, as well as greater flexibility. As a result, when modern peakers are used, they generally earn at least some money in the market or save fuel and purchased power costs.<sup>221</sup> They also can earn revenue from selling dispatch rights in the 10-minute (nonspinning) reserve ancillary service market. This revenue should be netted against the cost of the combustion turbine, because it pays a portion of the cost of capacity.

4. Peaking generation may not be the least-cost capacity resource. It is possible for an intermediate resource such as a combined cycle generator to have a lower net cost than a combustion turbine. In particular, the capital and long-term O&M cost of the combined cycle generator minus the revenue that it would earn in the market or the fuel it would save can be less than the cost of a combustion turbine. Even with excess capacity, this outcome can sometimes occur, particularly if a relatively expensive turbine is erroneously considered as the peaking unit (as discussed earlier in this list).
5. Storage costs may be cheaper than combustion turbines. Under current conditions, it is possible that storage costs net of energy savings relative to market prices can be cheaper than conventional peaking generation. In particular, PG&E is installing and contracting for about 550 MWs of batteries with four-hour storage to meet system needs and replace 570 MWs of RMR peaking and

219 A utility might have installed some of these smaller turbines for reasons such as alleviating transmission constraints, meeting time constraints (if the smaller turbines had less stringent siting requirements) or responding to specialized system needs such as black start capability.

220 See, for example, Phillips (2018, pp. 5-11), where the testimony argues for the usage of a 50-MW turbine costing \$1,600 per kW instead of a cheaper 100-MW turbine.

221 See Section 1.1 for more discussion and quantitative examples of this phenomenon.

combined cycle generation (Maloney, 2018; California Public Utilities Commission, 2018). RMR generation receives payments on a cost of service basis including capital and operating costs, although the specific plants being replaced are partly depreciated.

6. Additionally, pure capacity can be available at considerably lower costs than a combustion turbine. Systemwide actual and projected prices in the California resource adequacy markets are \$30 to \$40 per kW-year over the period of 2017-2021 (Chow and Brant, 2018, p. 21) with even the peak monthly prices from July to September rising no higher than \$4.50 per kW-month (Chow and Brant, p. 32). Capacity market prices are generally similar in the PJM region, with higher prices in transmission-constrained pockets of New Jersey and occasionally other areas; new demand resources, renewables and gas-fired combined cycle generation have been added at those low prices (PJM, n.d.).<sup>222</sup> Resource adequacy capacity does not come with the physical hedge against high market prices provided by the combustion turbine's known heat rate, but it is much less costly. It is arguably the newest version of "pure capacity" as NERA originally defined it. PG&E estimates the capacity cost during a period of surplus as the long-term O&M cost of a combined cycle generating plant, because a combined cycle plant that could not earn its long-term O&M would go out of service, reducing any available surplus (Pacific Gas & Electric, 2016, Chapter 2).

In sum, the combustion turbine peaker that is the typical choice for marginal capacity costs under the NERA method, as well as under long-run incremental costs, is likely to significantly overstate capacity costs given the economics of new large-scale storage facilities and significant capacity surpluses.

To the extent there is a marginal capacity cost for ramping capability, it can best be understood as an hourly capacity cost that is negative in the hour or two before the ramp begins, a positive hourly cost in the steepest several hours of the ramp and lower but still positive hourly cost as the ramp becomes flatter, continuing through and just beyond the evening peak.

But, for allocation purposes, the cost needs to be first divided between ramp caused by customer loads and ramp caused by generation characteristics, which should be feasible. This is another example of how the emerging wind- and solar-dominated grid challenges traditional methods of cost allocation. To the extent that the need for capacity for ramping, and hence part of its cost, is caused by generation characteristics, it should not be a load-related marginal cost for allocation to the classes that contribute to the ramp.<sup>223</sup> The generation-related ramp effectively becomes part of the cost of the generation resources causing the ramp under a short-run marginal cost theory, such as the one NERA defined. To the extent that generation-related ramping costs are recovered as incurred periodically in energy costs or ancillary service or other charges from the RTO, they should be part of marginal energy costs. Although these concepts are relatively clear, their implementation is not clear at all, with disagreements among parties on both the generation-related portion of ramp costs, the definition of ramp hours (for example, whether more than one large ramp should be counted on a single day) and the method of allocating costs to both hours and classes. Storage units are more effective for ramping than thermal peakers because they can both charge in the preramp hours and discharge to clip the peak, reducing the total amount of ramp more than a thermal plant, whether the storage is installed as a bulk power resource or for other purposes.

<sup>222</sup> Similar capacity prices have prevailed in New York, outside the New York City load pocket (New York Independent System Operator, n.d.). Capacity prices in MISO are even lower due to a continuing surplus and renewable additions, while prices in New England were higher for a few years after 2016 and have recently fallen to the California range.

<sup>223</sup> Although the generation-related cost should not be part of the class allocation, it may be appropriate to include some of that cost in rate design to provide a greater discouragement to ramping loads.

## 20. Transmission and Shared Distribution in Marginal Cost of Service Studies

### 20.1 Marginal Transmission Costs

**M**arginal transmission costs have not received the attention that marginal generation and distribution costs have received, because in large parts of the country transmission is partly if not wholly under FERC jurisdiction. Thus, California utilities only calculate marginal transmission costs as an input to the process of calculating the contribution to margin of economic development rates, rather than for cost allocation and rate design. Nevada calculates marginal transmission costs using the NERA method. But since there is no joint product (such as generation energy and capacity, or distribution lines and customer connections) and Nevada allocates costs by functions (see Chapter 24), there is little controversy. Southern California Edison breaks its transmission costs into transmission (115 kV and above) and subtransmission (69 kV and below) because specific factors relating to the physical layout of its system left its subtransmission system under Public Utilities Commission regulation, where it is treated as part of the company's distribution marginal costs.<sup>224</sup>

The NERA method for marginal transmission costs involves some analysis of the relationship between transmission system design and peak loads. Although the original method involves regression analysis between cumulative investment in load-related transmission (calculated in real, inflation-adjusted dollars) and cumulative increases to peak load, two other methods have been developed. The first, the total investment method, examines total investment divided by the change in peak load. The second, the discounted total investment method, uses discounted total investment divided by the discounted change in peak load. This assigns lower weights to investments occurring later in a projected analysis period relative to

investments occurring earlier. The specific choice among these three methods can create relatively small differences (unless miscalculated). The investment cost is annualized by multiplying by the RECC. Investment costs are defined narrowly. As an example typical of most utilities, Southern California Edison stated in its most recent rate design case:

Projects discretely identified as load growth are only considered in the analysis. All projects not related to load growth (i.e., grid reliability, infrastructure replacement projects, grid modernization, automation, etc.) are excluded from this analysis (2017b, p. 37).

The NERA method can be applied to the transmission system as a whole or to transmission and subtransmission voltage levels and to lines and substations separately.

O&M costs are added to the annualized capital costs. There are two conceptual methods for doing this. The original NERA method averages O&M costs (in real terms) divided by kW of load (i.e., calculated in dollars per kW) over a period containing both historical and forecast years. An alternative method used by PG&E calculates O&M costs as a percentage of plant and adds it only to the new plant. Using this method, O&M costs are lower because the assumption is made that O&M is tied to new plant rather than maintaining the system in order to retain all loads.

The NERA method essentially ignores large parts of the transmission system and therefore generally ends up with marginal transmission costs well below embedded costs. It also fails to recognize that peaking resources and storage are

---

<sup>224</sup> California utilities calculate a marginal cost of transmission as an element of cost when determining how much contribution to margin is provided by loads such as economic development rates, but it is not used for allocation of costs to customer classes (which is done by FERC) and is therefore not reviewed carefully in rate cases.



often strategically located near loads where transmission is constrained to reduce the need for transmission. For example, the city of Burbank, California, incurred additional costs to locate the Lake generating unit in the heart of the urban area; an offsetting benefit was avoidance of transmission costs.

First, interties to connect utilities, or to connect remote generation plants for purposes of obtaining cheaper sources of generation and increasing imports of generation capacity, are often simply ignored. They are treated as “inframarginal” sources of generation (built because they were theoretically cost-effective relative to the existing system without those lines). As a result, the cost of interties ends up neither in the marginal generation costs (where the only effect is to depress short-run marginal energy costs) nor in the marginal transmission costs (because the NERA method assumes them to be a source of cheap generation). Nor do the net revenues the utility receives for off-system energy sales (to the extent that the concept still exists in competitive wholesale markets) end up as an offset to transmission costs, even though such sales could be one reason for constructing intertie capacity.

The second set of costs that methods like the NERA method ignore is the cost of system replacement. The argument is that once the utility commits to build one system of transmission, the RECC method has the effect of deferring all replacements. The end result is that, as pieces of the system that were built 30 to 60 years ago are replaced, they are part of the embedded costs but not part of the marginal costs. System replacements can be a significant portion of the cost of new rate base. This issue is discussed further in the next section.

Third, any transmission and distribution costs related to improving reliability on the existing system (instead of specifically adding new capacity) or automating the system (to improve reliability or reduce capacity needs) are excluded under the pure version of this method. This exclusion is at variance to the theory of marginal generation costs, where in equilibrium the value of avoided shortages equals the value of the least-cost resource able to meet the need. Here, avoided shortages are assigned no value.

Fourth, the transmission and subtransmission systems are heavily networked and are built to avoid outages under

various load conditions throughout the year with one or two elements of the system out of service. This networking essentially means that even though the NERA method relates investment to peak, the cost causation of that relationship is unclear, and a significant portion of costs may be related to lower-load hours than the peak. The hourly allocation methods discussed in Section 25.2 may provide guidance in treating some transmission costs in marginal cost studies, by assigning these costs to all hours in which the assets are deployed.

## 20.2 Marginal Shared Distribution Costs

The most controversial issue for the calculation of marginal distribution costs is the same issue raised in the embedded cost section. Is a portion of the shared distribution system, particularly the poles, conductors and transformers in FERC accounts 364 through 368, customer-related? The authors of this manual believe strongly that these costs are not customer-related; Section 11.2 on embedded costs addresses this question in detail. This section will comment only on some specific issues of the customer/demand classification as they apply specifically to marginal costs for the shared elements of the distribution system.

The NERA method for marginal distribution capacity costs unrelated to customer connections is similar to that for marginal transmission costs, involving an analysis of the relationship between distribution system design and peak loads. Again, the three methods used are regression analysis, the total investment method and discounted total investment method, all discussed in Section 20.1. The investment cost is annualized by multiplying by the RECC.

The marginal cost of distribution capacity can be developed for the distribution system as a whole, as well as separately for lines and substations. A number of utilities (including Southern California Edison, San Diego Gas & Electric and the Nevada utilities) have separate calculations for distribution substations and lines. PG&E uses regional costs. It calculates costs individually for more than 200 distribution planning areas for purposes of economic development rates and aggregates them up to 17 utility

divisions for purposes of marginal cost calculation for cost allocation and rate design (Pacific Gas & Electric, 2016, chapters 5 and 6). Using all of the distribution planning areas (as was proposed in the 1990s) is so granular that it would be difficult to examine and audit the relationship of costs to cost drivers. This is true in part because costs are dependent on the amount of excess capacity in local areas. In addition, customers who are large relative to the distribution system may never pay for capacity needed to serve them in some cases. And customers in slow-growing areas are charged less than those where load is growing faster, even if those customers are using a significant portion of the distribution system.

O&M costs are added to the annualized capital costs. As with transmission, there are two conceptual methods for doing this. The original NERA method averages O&M costs (in real terms) divided by kW of load over a period containing both historical and forecast years. The alternative would calculate O&M costs as a percentage of plant and include it as an adder only to new plant.<sup>225</sup>

Southern California Edison and San Diego Gas & Electric aggregate all primary distribution circuit costs, including those that are part of line extensions, and treat them as demand costs. PG&E treats all primary distribution costs associated with line extensions as demand costs, again calculated regionally, but uses a different, less diverse measure of demand — demand at the final line transformer, rather than demand at the substation, to allocate these costs (Pacific Gas & Electric, 2016, Chapter 6).

The Nevada utilities make a distinction between costs covered by the line extension allowance (which they call facilities costs) and other distribution substation and circuit costs. Facilities costs are allocated to customer classes based on the cost of facilities built for each class that are recovered from customers because they are less than the line extension allowance. Costs are higher in dollars per customer in nonresidential classes than in the residential class. These costs are annualized by the RECC and have O&M added to them (Walsh, 2013, p. 9). This treatment is identical to the **rental method** for customer connection costs discussed in Section 21.1. Thus, as the line extension allowance is

increased, more costs are allocated to residential customers because land developers pay fewer of them. Unlike most utilities, the Nevada utilities have separate rates for single-family and multifamily customers. The result of this split of the residential class is that multifamily customers, with less expensive hookups on a dollars-per-customer basis, do not subsidize single-family customers, in contrast to the case across most of North America when distribution circuit costs are partly assigned on a per-customer basis. We discuss the class definition issue in Section 5.2.

Central Maine Power, which uses marginal costs to allocate distribution costs, also divides the distribution system between line extension and other distribution facilities and uses a different allocation among classes for line extension costs that allocates the costs more heavily to residential customers (Strunk, 2018, pp. 14-18).

Pacific Power's Oregon rate cases have a "commitment-related" component to primary distribution costs that is similar to the minimum system methods used by utilities conducting embedded cost studies and has similar issues (Paice, 2013, pp. 6, 9-11). Although the Oregon utility commission has accepted this for interclass cost allocation purposes, it does not include these as customer-related in the rate design phase of rate-making (B. Jenks, Oregon Citizens' Utility Board, personal communication, June 4, 2019).

The NERA method again ignores replacement costs, which constitute the majority of new distribution plant for many utilities' systems, in addition to ignoring costs of improving reliability. A good argument can be made that replacement costs are truly marginal costs and that the utility needs to make replacements to serve its existing load safely and reliably. First, regardless of the workings of the RECC method, assuming that replacement costs are automatically committed when a new piece of distribution equipment is built is a monopoly-based argument and does not work in a truly competitive market. The marginal cost relates to both incremental and decremental demand. A replacement is needed to assure that demand does not decline but is instead

---

<sup>225</sup> This is PG&E's method because the company claims that O&M costs are not marginal once the plant is installed (Pacific Gas & Electric, 2016, Chapter 5, p. 11).

served reliably. The fact that replacements are a marginal cost can be analogized to other industries, such as trucking. A more detailed theoretical exposition is given in Appendix D.

Adding in replacement costs (calculated in dollars per kW like O&M costs, but with an adder for the present value of revenue requirements) has been estimated in the past to increase marginal costs for Southern California Edison by 40% for distribution and 31% for subtransmission (Jones and Marcus, 2015, p. 30) and for PG&E by 46% for primary distribution and 27% for new business (Marcus, 2010b, pp. 36-37). Replacement costs were included as marginal costs in the 1996 PG&E gas cost adjustment proceeding (California Public Utilities Commission, 1995) but have not been included in any electric marginal costs because all California cases have been settled for almost 25 years.

Some distribution costs that are similar to replacement costs are actually policy-related and may not be marginal costs as a result (e.g., urban undergrounding of overhead lines; other changes related to safety and environmental protection). As with embedded costs and for the same reasons, costs in FERC accounts 364 through 367 should be considered as common system costs rather than as costs assigned to individual customers. Even though they are included in Account 368, as with embedded costs, capacitors and regulators need to at least be functionalized as primary distribution costs when calculating marginal costs, unless the dual function of the capacitor as a generation resource is recognized,<sup>226</sup> just as with embedded costs. They reduce losses and increase distribution capacity by supporting voltage and reducing amounts of reactive power.

Many smart grid investments such as automated switching and integrated volt/VAR controls (as well as potential investments in storage and targeted demand response programs) increase overcapacity and reduce distribution marginal costs calculated using the NERA method by reducing the need to build new lines. Under this method, this overcapacity will cause customer costs to be emphasized relative to other distribution costs.

Distribution marginal costs end up with tricky calculation issues because of differences in the determinants on which marginal cost calculations are made and the costing

determinants on which revenue allocation is conducted. Not all kW are equal. This issue is referenced here as a concern regarding marginal distribution costs but is addressed in more detail in Chapter 24 on reconciling marginal costs to embedded costs.

The transformer is an intermediate piece of equipment. In the larger C&I classes, a transformer will often serve a single secondary voltage customer, while for residential customers it may serve a single rural customer, a group of six to 10 suburban customers or 50 apartments or more. In the small and medium commercial classes, several customers are served by a single transformer in some cases, while some customers (particularly larger or three-phase customers) are served with single transformers. There are also differences in cost between single-phase and three-phase transformers. Single-phase equipment is adequate for serving nearly all residential customers and many small commercial customers.

Some utilities have allocated these costs to classes as marginal costs based on the average cost of a transformer serving the class. If this treatment is used for class allocation, transformer costs should not be fixed customer costs for purposes of rate design because of the wide variety of customer sizes and transformer configurations. In older urban areas, secondary line is often networked across several transformers, with some service drops connected directly to the transformer and some connected to the networked secondary line. In these cases, the use of secondary lines to connect the transformer to the customer is more of a common cost than a connection cost, unlike in more modern design configurations, where secondary distribution might be an economic alternative for customer connection.

If a transformer cost is considered part of the customer connection function, a portion of transformer costs is likely not marginal costs, and only the cost of the smallest transformer should be included. Transformers typically are purchased using an algorithm to minimize the present value of capital costs and load-related and nonload-related (core) losses. The extra costs of the transformers above the

---

<sup>226</sup> If a capacitor is deemed to have a generation function, it is not a marginal cost at all under the NERA method.

minimum costs would be inframarginal costs of providing energy and capacity rather than customer connection costs. However, these extra costs have been difficult to measure in past cases. Also, many utilities claim that the new energy standards for line transformers mean they no longer need to optimize transformer costs against losses and they only

need to meet but not exceed the federal standard. Capacitors and voltage regulators are also not part of transformer costs for either customer connection or secondary distribution demand but instead should be quantified together with other primary distribution costs.

## 21. Customer Connection and Service in Marginal Cost of Service Studies

The customer connection costs, also known as point of delivery costs, include the service drop and meter and may include the final line transformer and any secondary distribution lines that are not networked with other transformers.<sup>227</sup> Primary lines are typically not point of delivery costs, although several utilities include either line extension costs or some type of minimum system as customer costs. The basic customer method primarily includes the service and meter, although some states include a transformer. As a matter of calculation, it is necessary to determine a meter cost for each customer class. Additionally, customers cause the utility to incur costs of billing, collections and similar items.

### 21.1 Traditional Computation Methods

There are two longstanding methods for computing marginal customer connection costs. The first is the rental method, where the cost of new customer connection equipment is multiplied by the RECC to obtain a value at which a customer could be presumed to rent the equipment from the utility. O&M costs are added to these annualized capital costs. This method is a direct continuation of the NERA method.

The second method is the new-customer-only (NCO) method. It calculates a marginal cost based on the number of new hookups (and possibly replacements) of customer connection equipment in the same time frame as used to measure other marginal costs for generation and transmission. This cost is adjusted by a present value

of revenue requirements multiplier to reflect the costs of income taxes and property taxes under utility ownership. Elements of the method were introduced by consumer advocates who recognized that the incremental and decremental costs of hooking up new customers were different (unlike most marginal cost elements) in the mid- to late 1980s. The specific NCO method was first presented by PG&E (in 1993; it has since disavowed the NCO method) and was adopted by consumer advocates with modifications after that time. Again, O&M costs are added.

The rental method has the longest time horizon of all the marginal cost methods in the entire panoply of marginal costs developed by NERA and used by regulators. All customers are assumed to rent equipment based on today's costs and configurations of customer connection equipment, which is largely underground in most newly constructed urban and suburban distribution systems. The method as utilities now implement it generally does not consider the standing stock of equipment. As a result, the rental method assumes that customers with overhead service in urban areas are charged in marginal costs as if they had underground service. So these customers not only have to look at wires and poles, but they face a revenue allocation that assumes they have the amenities of modern suburbs. By failing to use the standing stock, the rental method also assumes that the percentage of new housing stock built as apartments is the same as the percentage of existing housing units that are apartments.<sup>228</sup>

Besides these computational issues, there are significant theoretical issues that caused the development of the NCO

227 A secondary distribution line that is not networked is installed to reduce costs (including line losses) relative to running all services directly off a single transformer. It is thus an economic substitute for longer service lines.

228 The exception to this concern is Nevada, where separate marginal customer costs are calculated for single-family and multifamily homes based on new costs but are applied to the existing stock of each type of

housing. This practice has been in place since at least 1999 when the utilities presented the division of the residential class in Public Utilities Commission of Nevada dockets 99-04001 and 99-04005. San Diego Gas & Electric calculates customer connection costs based on the noncoincident demand of the customers and uses demand estimates of existing customers, which also ameliorates this problem to some degree (Saxe, 2016, pp. 6-10).

method. Aside from computational inaccuracies from not using the standing stock, the rental method is not the outcome of a true competitive market. The NCO method reflects as marginal only those costs that are avoidable — incurred at the time when the choice to spend or not spend money on new hookups is made — when the customer chooses to connect to the utility system or when a hookup is replaced. It is thus a shorter-run marginal cost method than the rental method, making the NCO method more consistent with the other short- and intermediate-term means of calculating costs included in the rest of the NERA method. The cost analyst must carefully examine the consistency between the NCO method, which considers the full costs of system replacement, and the methods used for G&T. If replacement costs are used for one category, they should be used for all categories, moving the study toward a total service long-run incremental cost study (see Section 25.1).

The NCO method also comports better with competitive markets and consumer behavior. Consumers typically have the choice to either own or rent any equipment affixed to their homes that costs several hundred to a few thousand dollars. In many cases, consumers nearly always own the equipment, as in the case of curtains or chandeliers. In other cases, there is consumer choice as to ownership or rental, as with propane tanks, solar energy systems,<sup>229</sup> internet routers and (in some parts of North America) water heaters. Even where the rental option is present, the consumer can choose to purchase the equipment. In contrast, the rental method does not simulate the outcome of a competitive market. It is equivalent to assuming there are enough landlords that there is a competitive rental market, who own all the property in a given community. Anyone who wants to live in that community has to rent from one of these owners; no one is allowed to buy property. Rather, this is a market with barriers to entry that prevent true competition. Thus, the analogy of the current rental method to the housing market places an anti-competitive constraint on consumers that would limit their economic choices while

protecting the profits of the landlord — or the utility, in this case — from the vagaries of competition.

There is one additional computational issue in the NCO method, where the replacement rate may or may not be considered. In California, the utility commission advocacy office has omitted replacements from the NCO method as well as from calculations of marginal distribution costs. The Utility Reform Network tends to include them for both, yielding higher costs for both demand distribution and customer-related costs. If a replacement cost is needed for the NCO method, utilities often use the highest possible number — the inverse of the depreciable life of the equipment. Although data for service drops may be limited, utilities often have actual rates of replacement of meters and transformers, as well as information that could allow the replacement rates for service drops to be inferred from capital budgeting documents.<sup>230</sup>

## 21.2 Smart Meter Issues

For utilities installing smart meters, a joint product issue arises. A smart meter with the associated data collection network hardware and software serves multiple functions. It provides customer connection and billing while reducing the labor costs of meter reading and other functions. It can also provide a number of other peak load, energy and reliability functions, including enabling TOU pricing and measuring demand response; load research; distribution smart grid functions such as outage detection and (if tied to utility GPS and mapping functions) identification of potential transformer overloads; and even, in some cases, internet access for utility customers.

The NERA method provides a theoretical underpinning that customer connections (analogous to generation capacity) should be provided by the least-cost method. In evaluating past smart meter cases, about 70% of the cost of the AMI system was covered by meter reading benefits; the remainder of the cost was justified by other benefits. Therefore, California

229 Solar systems may be a special case. Renting the equipment generates some tax benefits that can be passed to the consumer in lower rent, while ownership would not have the same tax advantages. This will change if the solar investment tax credit is allowed to expire after 2020 as would occur under current law.

230 There is an accounting issue for meter replacement, because the cost of the meter is capitalized but the cost of meter replacement O&M is often expensed (see Section 21.3). It is important not to count the same cost twice.

ratepayer advocates typically have argued that only 70% of the cost was a customer connection and billing cost and the remainder was not a marginal customer cost. Alternatively, in other studies, more than 100% of the smart meter and data collection installation cost is justified by other savings in power supply and line losses, rendering the metering and meter reading function as a cost-free byproduct.

The division of the smart meter into connection and billing and other benefits can be analyzed in a different way — by netting out all benefits from the smart meter aside from those associated with meter reading and customer accounts, leaving the remainder as connection-related. This is analogous to calculating a marginal capacity cost based on a combined cycle power plant net of savings of fuel and purchased power if it is cheaper than a combustion turbine.

### 21.3 Operations and Maintenance Expenses for Customer Connection

Most utilities that use marginal costs assign the costs of FERC accounts 586 and 597 (meter operations and maintenance) and possibly portions of accounts 583, 584, 593 and 594 (operations and maintenance of underground and overhead lines) related to services and transformers as customer-related. If a transformer is customer connection equipment, Account 595 (transformer maintenance) is also customer-related. Utilities also assign portions of overhead accounts 580 (supervision and engineering), 588 (miscellaneous operating expenses), 590 (maintenance supervision) and 598 (miscellaneous maintenance expenses) to the customer costs. The treatment of these expenses is often an issue, as the specific costs in many of these areas may be more related to shared distribution system costs than to customer connections. These costs typically are developed using an average of several years of historical data and several years of future data.

There are several computational issues.

First, at least some utilities include the labor cost of replacing a meter in Account 586 (Jones and Marcus, 2016,

citing San Diego Gas & Electric testimony). Effectively, the cost of replacing meters for customers needing replacement is included in both the O&M costs and the capital costs (because the lessor has the responsibility of replacement in the rental method and the replacement is included in the NCO method). Therefore, replacement meter costs should be removed from Account 586 in the rental method because they would otherwise be double-counted as part of the rental cost. In the NCO method with replacement, the costs of meter installation should be removed from the capital costs for replaced units and left in Account 586 to reflect recurring replacements.

Second, there are issues relating to the real costs of operating and maintaining service drops, some of which also must be dealt with in embedded cost analysis. Utilities may assign costs to service drops based on investment or line miles. But as a practical matter, utilities spend very little on service drops as compared with primary distribution lines. In particular, many utilities have vegetation management standards almost entirely tied to primary lines. They rarely trim trees around secondary wires, except incidentally when primary line trimming is needed, and even more rarely trim trees around service drops, except under emergency conditions. Aside from tree trimming, patrols and inspections are driven by primary lines, not service drops. Therefore, it is necessary to conduct utility-specific analysis on service drop maintenance.

A third issue is that some of the costs in Account 588 are not marginal costs at all. For example, PG&E in a previous case included costs of obtaining additional revenue from nontraditional sources and costs of performing work reimbursed by others. Other costs do not apply to customer connection equipment (environmental costs and mapping expenses that generally do not apply to services and meters).

In addition, if smart metering is in the process of being installed or has just been installed, O&M costs of smart meter installation may be part of accounts 586 and 587 in some historical years. In that case, it will be necessary to identify and remove those costs or use a historical period of time entirely after smart meter installation.

## 21.4 Billing and Customer Service Expenses

A marginal cost analysis of billing and customer service expenses is usually done in one of two ways. The most common way, following the NERA method, is to average costs over a number of historical and projected years. These costs are calculated per weighted customer, recognizing that certain activities are more heavily related to some customers than others. The second method is to use the costs of revenue cycle services, which are **short-run incremental costs** used to pay competitive service providers, plus similar short-run calculations for call centers and other activities. These costs are less than embedded costs of the same functions used in the NERA method. PG&E chose this method in Phase 2 of its 1999 general rate case to be consistent with the lower marginal costs it calculated for paying competitors; it has kept this design ever since. A method based on revenue cycle services is more consistent with a short-run marginal cost theory, but many utilities may not have the ability to implement it.

Many of the issues related to the appropriate calculation of marginal costs of billing and customer service are similar to the embedded cost issues raised in this manual. As with the discussion of this issue in Section 12.1, the frequency of billing and collection is driven by usage; if customers used minuscule amounts of power, it would not be cost-effective to read meters (without smart meters) or even bill on a monthly basis. For utilities without AMI, costs in excess of bimonthly meter reading and billing could be considered revenue-related rather than related to customer accounting. Relatedly, if smart meters are being implemented or have recently been implemented, meter reading costs from periods before smart meter implementation (as well as other costs such as call center costs associated with the implementation process) must be removed to prevent double counting of the capital cost of the smart meter and the operating cost of the mechanical meter that the smart meter replaces. As with embedded costs (see Section 12.3), the costs associated with major account representatives assigned to serve large customers (regardless of the FERC accounts in which they are found) should be considered part of the marginal costs of serving those customers and should be assigned to them.

As with customer-related distribution costs, in jurisdictions using long averages with both present and future costs, the future cost forecast must be reasonable. In the specific case of customer accounting costs, a trend toward declining costs and increasing productivity has persisted for almost a decade. More customers are receiving and paying bills online or through automatic bank transactions, both of which are less expensive to the utility than mailing bills and payment envelopes to the customer and then opening and processing return envelopes with payments from customers. Phone calls to the utility are being replaced with internet transactions (even for items such as changing service or making payment arrangements) and the use of interactive voice response units. Even though utilities may claim that the remaining calls may be more complex, customer service representatives are logging fewer total hours. As a result, it is important to examine any set of averaged costs carefully. If costs are declining, as they should be, then an average would include costs from a period of worse productivity than the present and should not be used. Similarly, if the future is projected to be more expensive than recent history, that assumption should be probed for reasonableness.

Some customer accounting and customer-related metering and distribution O&M expenses are paid by fees, not rates (see Chapter 15). As a result, they are not marginal costs associated with the general body of ratepayers. Costs of activities such as establishing service; disconnection and reconnection after customer nonpayment; field collections; meter testing; and returned checks are offset by fees received from individual customers (largely residential customers). If the costs paid by the fees are allocated heavily to residential customers, but the fees are not included in the revenue to be allocated, this would effectively cause residential customers to pay twice: once in the rate and a second time when assessed the fee. This problem can be dealt with in either of two ways. Nevada includes the fees in the revenue to be allocated and directly assigns the fees as revenues received from the classes that pay them. California generally removes an amount equal to the fees from the marginal customer accounting cost. The methods are not identical, but both will address the double counting. Costs (and uncollectible



accounts if necessary) related to billing and collecting money from non-energy activities such as line extension advances and other products and services besides the utility's energy bills may be in accounts 901 through 905, but they are not marginal costs of serving electric customers and should be excluded from marginal customer costs. This is similar to the approach in Section 15.2 for embedded costs.

In some cases, the difference between marginal and embedded cost analysis is that costs are excluded from marginal costs while being allocated differently from other costs as embedded costs. Examples are economic development rates and uncollectible accounts expenses. Economic development rates, as well as any costs for marketing and load retention, are not marginal costs. These programs are not needed for customer service and theoretically should pay for themselves by attracting or retaining loads or improving economic conditions in the area. Uncollectible accounts expenses are not marginal costs associated with current bill-paying customers and conceptually should not be included in marginal costs. This is a similar issue to the embedded cost issue, discussed in Section 12.2, regarding whether uncollectible accounts expenses are costs associated with present customers (direct assigned) or former customers (allocated by usage or revenue). California regulators removed uncollectible accounts expenses from marginal costs in 1989 (California Public Utilities Commission, 1989); the Nevada commission includes them (Public Utilities Commission of Nevada, 2002, p. 109). If uncollectible accounts are included, then late payment revenues must be treated consistently, by adding them to the distribution revenues to be allocated and subtracting them from the classes that pay them.

Lastly, a number of cost elements that are sometimes mistakenly classified as customer service do not fit a marginal cost analysis well, particularly if the programs are undertaken for public policy reasons. A cost undertaken for public policy reasons is not a marginal cost, even if it might theoretically vary with the number of customers. An energy efficiency program or demand response program is established by the state or regulators for policy reasons, theoretically to provide a cost-effective or environmentally preferred substitute for other investments and expenses. Subsidy programs for low-income customers are also established for policy reasons. Certain other programs are also policy-related, such as promoting solar energy, battery storage and electric vehicles; allowing customers to opt out of smart meters; and research and development programs. These are not marginal costs, and their allocation to customers outside of a marginal cost framework will be discussed in Chapter 23.

## 21.5 Illustrative Marginal Customer Costs

Tables 42 and 43 on the next pages illustrate a calculation of marginal customer costs using the NCO and rental methods, with a set of assumptions that are generally realistic but not tied to any specific utility.

Table 44 on Page 213 shows the impact of the choice of marginal customer cost methods on the MCRR of distribution and thus on the overall allocation of distribution costs. To illustrate this impact, there is also an assumption as to demand distribution costs. Costs for primary customers are assumed to be lower than for other classes largely because they do not need line transformers. In this example, the residential class has 41% of the MCRR for distribution costs with the rental method but 38.8% with the NCO method.

Table 42. Illustrative example of new-customer-only method for marginal customer costs

	Residential	Small commercial	Secondary large commercial	Primary industrial
<b>Initial investment</b>				
Service	\$800	\$1,200	\$3,000	N/A
Meter	\$200	\$300	\$3,000	\$9,000
Total	\$1,000	\$1,500	\$6,000	\$9,000
<b>Present value of revenue requirements (PVRR) factor</b>				
Service	1.3	1.3	1.3	1.3
Meter	1.25	1.25	1.25	1.25
<b>Investment with PVRR</b>				
Service	\$1,040	\$1,560	\$3,900	N/A
Meter	\$250	\$375	\$3,750	\$11,250
Total	\$1,290	\$1,935	\$7,650	\$11,250
<b>New customers (% of system)</b>	1%	1%	0.5%	0%
<b>Replacements (% of system)</b>				
Service	0.5%	0.5%	0.5%	0.5%
Meter	2%	2%	2%	2%
<b>Marginal cost for new customers (investment with PVRR x new customer %)</b>				
Service	\$10.40	\$15.60	\$19.50	N/A
Meter	\$2.50	\$3.75	\$18.75	N/A
Total	\$12.90	\$19.35	\$38.25	N/A
<b>Marginal cost for replacement (investment with PVRR x replacement %)</b>				
Service	\$5.20	\$7.80	\$19.50	N/A
Meter	\$5.00	\$7.50	\$75.00	\$225
Total	\$10.20	\$15.30	\$94.50	\$225
<b>Total investment marginal cost for new and replacement customers</b>				
Service	\$15.60	\$23.40	\$39.00	N/A
Meter	\$7.50	\$11.25	\$93.75	\$225
Total	\$23.10	\$34.65	\$132.75	\$225
<b>Customer operations and maintenance cost</b>	\$30	\$50	\$500	\$700
<b>Total marginal customer cost</b>	\$53.10	\$84.65	\$632.75	\$925
<b>Number of customers</b>	1,000,000	100,000	10,000	1,000
<b>Marginal cost revenue requirement for customer costs</b>	\$53,100,000	\$8,465,000	\$6,327,500	\$925,000

**Table 43. Illustrative example of rental method for marginal customer costs**

	Residential	Small commercial	Secondary large commercial	Primary industrial
<b>Initial investment</b>				
Service	\$800	\$1,200	\$3,000	N/A
Meter	\$200	\$300	\$3,000	\$9,000
Total	\$1,000	\$1,500	\$6,000	\$9,000
<b>Real economic carrying charge rate</b>				
Service	7%	7%	7%	7%
Meter	10%	10%	10%	10%
<b>Annualized investment cost</b>				
Service	\$56	\$84	\$210	N/A
Meter	\$20	\$30	\$300	\$900
Total	\$76	\$114	\$510	\$900
<b>Annual customer operations and maintenance cost</b>	\$30	\$50	\$500	\$700
<b>Total customer cost</b>	\$106	\$164	\$1,010	\$1,600
<b>Number of customers</b>	1,000,000	100,000	10,000	1,000
<b>Marginal cost revenue requirement for customer costs</b>	\$106,000,000	\$16,400,000	\$10,100,000	\$1,600,000

**Table 44. Illustrative comparison of rental versus new-customer-only method for overall distribution costs**

	Residential	Small commercial	Secondary large commercial	Primary industrial
<b>Marginal cost revenue requirement for customer costs</b>				
Rental method	\$106,000,000	\$16,400,000	\$10,100,000	\$1,600,000
New-customer-only method	\$53,100,000	\$8,465,000	\$6,327,500	\$925,000
<b>Marginal distribution demand cost per kW</b>	\$100	\$110	\$110	\$75
<b>Demand per customer (kW)</b>	4	25	250	2,000
<b>Number of customers</b>	1,000,000	100,000	10,000	1,000
<b>Marginal cost revenue requirement for distribution demand costs</b>	\$400,000,000	\$275,000,000	\$275,000,000	\$150,000,000
<b>Results: Rental method</b>				
Total distribution marginal cost revenue requirement	\$506,000,000	\$291,400,000	\$285,100,000	\$151,600,000
Share of distribution costs	41.0%	23.6%	23.1%	12.3%
<b>Results: New-customer-only method</b>				
Total distribution marginal cost revenue requirement	\$453,100,000	\$283,465,000	\$281,327,500	\$150,925,000
Share of distribution costs	38.8%	24.3%	24.1%	12.9%

Note: Based generally on California examples, except transformer part of demand cost. Marginal demand cost is higher in commercial classes than residential because residential has more customers per transformer. Demand is lower in industrial class because no transformers or secondary lines are included. Percentages may not add up to 100 because of rounding.

## 22. Administrative and General Costs in Marginal Cost of Service Studies

**B**oth A&G expenses and general plant costs are typically considered “loaders” to marginal costs, applied to the generation, transmission and distribution functions. Fundamentally, at least some A&G expenses and general plant costs are marginal costs, though over varying time horizons and in varying amounts because of economies of scale in running a large corporation.

The NERA method in the 1970s used an extremely long-run marginal cost method for A&G costs. It developed loading factors based on what appears to be a fairly arbitrary mix of labor, O&M expenses and total plant for A&G expenses, and it allocated general plant based on other plant (other capital investments). As with other elements of the NERA method, the mismatch in time frames is a serious theoretical concern. One method of addressing this is to eliminate consideration of joint and common A&G costs from the marginal cost analysis. This leaves only short-run marginal A&G costs as a better match with short-run generation marginal costs.

Short-run marginal costs include at least workers’ compensation and pensions and benefits associated with other marginal costs that are labor-related. Similarly, incentive pay, to the extent recorded to A&G accounts, is a short-run marginal cost assigned to labor. Property insurance is a plant-related marginal cost to the extent that the amount of insured property affects the premiums.

If longer-term A&G costs are included, one can either include all of them as variable in the long run with the size of the utility or recognize potential economies of scale, which would mean that only a portion of costs is marginal. The best example of an intermediate-term marginal cost is the human resources department, which varies with the size of the workforce. Other examples of costs that will vary with

the size of the utility in the intermediate term are benefits administration, accounts payable, payroll processing and capital accounting. Over a longer period, portions of an even broader set of costs are variable. For example, executive salaries are related (though possibly not proportional) to the size of the company, as a larger company will have more executives and pay them more (Marcus, 2010a, pp. 90-93 and Exhibit WBM-18). Other examples relate to buildings and other general plant items. A utility with fewer workers will own, rent and maintain less building space and have fewer vehicles and tools.

Recently a number of utilities, following the FERC method of unbundling transmission, have allocated both A&G expenses and general plant costs (using a long-run marginal cost basis) based on labor with the exception of (1) property insurance, which is based on plant, and (2) franchise fees based on revenue. The labor allocation method for A&G expenses tends to be less favorable to small customers than the plant-based method, but it has analytical merit. Key issues here are (1) ensuring that specific elements of A&G expenses are truly recurring marginal costs and (2) whether a given cost should be functionalized differently among generation, transmission and distribution. This can be as simple as, for example, removing a large one-time fire claim (which has no relationship to any cost drivers) from a utility’s recorded A&G expenses and removing nuclear insurance from liability insurance allocated by company labor when the company had no labor costs at a jointly owned nuclear plant (Jones and Marcus, 2016, pp. 20-21). Or it can involve a more complex analysis of which specific A&G costs are marginal, an exercise Southern California Gas Co. undertook in its gas marginal cost studies (Chaudhury, 2015, pp. 21-22).

## 23. Public Policy Programs

There are a number of costs related to public policy decisions by state regulators that generally should not be considered marginal costs. Consideration should be given to allocating these costs separately from marginal costs. Many states have explicit cost allocations for public policy or energy efficiency costs that are separate from base rates or distribution rates. In California, energy efficiency costs are largely, though not entirely, allocated in proportion to total system revenues, with generation revenues imputed to customers who do not receive generation service from the utility so that direct access and community choice aggregation customers do not pay lower rates for public purpose programs than bundled customers with otherwise similar characteristics.<sup>231</sup> California allocates low-income rate subsidies in equal cents per kWh to all customers except municipal streetlights and those customers receiving the subsidies.<sup>232</sup>

However, some policy-oriented costs related to demand response programs and other items have been included in distribution costs, so that all customers, including those who may purchase generation from others besides the utility, can be required to pay for them. In these cases, the allocation of a cost such as demand response by an allocator such as a distribution equal percentage of marginal cost (EPMC)

creates concerns. If costs of a demand response program that avoids generation are allocated by distribution EPMC (or even total EPMC), residential customers might be better off if the utility instead built generation of equivalent or, in some cases, higher cost, even if society would be worse off — because a smaller portion of the higher cost would be allocated to them. Even if a demand response cost is designed to avoid some T&D, the demand response measure generally will also reduce the need for generation capacity.

One framework used by consumer advocates in California applies different approaches to different subsets of public policy costs. It allocates the costs of direct programs that provide generation in distribution rates (e.g., interruptible and load management rate credits) by EPMC of generation (with generation marginal costs imputed to those not served by the utility). At the same time, it allocates programs that provide more broad public benefits (e.g., electric vehicle programs, research and development) or that create infrastructure to enable demand response (e.g., computer systems, the portion of AMI costs in excess of those that are cost-effective operationally for the distribution system) based on the equal percentage of revenue method discussed above for energy efficiency.

---

231 This method was essentially codified in A.B. 1890, California's restructuring legislation of 1996. Although the specifics of that legislation no longer apply, relatively similar methods have been used throughout the last two decades in a number of settled cases.

232 California Public Utilities Code § 327(a)(7): "For electrical corporations and for public utilities that are both electrical corporations and gas corporations, allocate the costs of the CARE program on an equal cents per kilowatt hour or equal cents per therm basis to all classes of customers that were subject to the surcharge that funded the program on January 1, 2008."

## 24. Reconciling Marginal Costs to Embedded Costs

It is only happenstance if marginal costs and embedded costs produce the same revenue. This raises questions as to how to reconcile these items. The most common method allocates embedded cost revenue requirements in the same proportion that marginal costs are allocated. This is typically called the equal percentage of marginal cost method but may also be known as equiproportional.

There are two types of EPMC allocation. The first allocates the entire revenue requirement by the entire marginal cost revenue responsibility, called total EPMC allocation.<sup>233</sup> This method was used in both California and Nevada through the 1990s. Under this method, if generation marginal costs are low (because of excess capacity, renewable penetration, low gas prices or other reasons), more of the system costs are allocated based on distribution costs, which are allocated more heavily to small customers. The result is problematic for small consumers. This was particularly evident in California, where high costs in the 1980s — created by power purchase contracts required under PURPA and additions of nuclear power — were heavily allocated based on distribution costs because of excess capacity, low system incremental heat rates due to large amounts of baseload power, and falling gas prices that did not reflect the expectation at the time the excess capacity was being constructed.

A second problem with this total EPMC allocation method is that it does not work well in quasi-competitive markets. If some customers have market options to acquire generation and others do not, as in California and Nevada, using an EPMC method based on total marginal costs could distort competitive choices by setting generation rates based

on a mix of generation, transmission and distribution marginal costs. As a result, both of these states now use an EPMC allocation by function. They separately allocate generation, transmission (in Nevada; California transmission used by investor-owned utilities is entirely under FERC jurisdiction) and distribution based on EPMC.<sup>234</sup>

The other less used approach for reconciling marginal costs to embedded costs is an economic approach known as Ramsey pricing and the resulting inverse elasticity rule.<sup>235</sup> Under this construct, any deviation from marginal costs creates an economic distortion. Advocates of this approach would reconcile marginal costs to embedded costs in the “least distortive” manner. At a high level this is reasonable, but there are many disputes about which choice is least distortive. Many advocates of this approach take a narrow view of societal costs and externalities and argue that the responsiveness of customer classes with respect to higher or lower costs — a concept known as elasticity of demand — is the key criterion. Relative elasticity of demand between rate classes, and between different rate elements for each rate class, is difficult to measure. Some advocates of the Ramsey pricing approach assume that residential customers are less responsive to changes in cost in the short term, particularly with respect to changes in the customer charge. But according to these advocates, if embedded costs are higher than the MCRR, then this leads to a larger share of costs being borne by residential customers, with those costs being recovered through higher customer charges for residential customers. These underlying assumptions may not have been true historically, but changing circumstances may weigh

233 The use of EPMC as a whole in California was first clearly adopted in 1986 (California Public Utilities Commission, 1986, pp. 636-646).

234 The unbundling of revenue allocation in California by function after the incomplete adoption of utility restructuring is discussed in Schichtl

(2002). The functionalization of EPMC in Nevada is found in Public Utilities Commission of Nevada (2007, pp. 162-167).

235 This method was named after Frank B. Ramsey, who found this result in the context of taxation. Later, Marcel Boiteux applied the rule to natural monopolies in declining cost industries.

even more heavily against this approach in the future. If externalities are incorporated, then in many circumstances per-kWh rates are actually lower than the full societal marginal cost of consumption — meaning it would be socially efficient to classify incremental costs as energy-related. Full incorporation of externalities, in fact, argues for a differential approach depending on whether the MCRR is lower or higher than embedded costs, classifying any incremental costs as energy-related for inclusion in kWh rates while classifying any excess revenue as customer-related to provide a reduction in customer charges.

In addition, certain types of multifamily buildings often face a choice between master metering and individual meters. This choice affects the number of customers and overall

customer charge revenue but has almost no effect on system cost other than meters and billing. The declining cost of storage and solar may enable growing numbers of customers to disconnect entirely from the grid as well. The experience in the cable television and telephone industries shows how people are willing to “cut the cord” to rely on nonmonopoly service providers. Lastly, even if the underlying claims from certain advocates of Ramsey pricing are correct, there are significant equity issues between classes at stake in the allocation of additional costs solely to the residential class. Similarly, using Ramsey pricing to pass those costs on through customer charges raises significant equity issues within the residential class, disproportionately affecting small users.<sup>236</sup>

---

<sup>236</sup> It could be the case that lower-income customers have a more elastic demand to pay for electric service if prices are increased because of limited ability to pay.

## 25. Cutting-Edge Marginal Cost Approaches

The NERA method for calculating marginal costs, particularly for generation, becomes less sustainable as the utility systems move toward major technological change and reductions in carbon. While the effect may be different in different regions of the country, the short-term avoided energy cost will reflect diminishing variable costs to the extent that natural gas is replaced with renewables and storage. Capacity costs may be moving toward batteries given that renewable integration can be achieved better with storage resources that can both use overgeneration and provide ramping and integration more effectively than fossil-fueled plants that do nothing about overgeneration. Thus, it is important to at least sketch out a new paradigm for marginal costs, even though many of the calculations on which it could be constructed have not been developed yet or integrated into a whole.

### 25.1 Total Service Long-Run Incremental Cost

The basic theory presented here is the total system long-run incremental cost method that was developed in the telecommunications industry during its period of rapid technological change before deregulation. Under this method, all costs are variable but may be very different from historical costs. This is important when examining the generation system in particular, because the optimal system going forward is likely to have very few traditional variable costs.

The TSLRIC is theoretically defined as the total cost of building and operating an optimal new system to serve the current load with changes that can be reasonably foreseen and changes to reflect environmental priorities (e.g., additional efficiency and demand response, changes to electrification for purposes of decarbonizing existing fossil fuel end uses and development of more loads with storage or other controls). The system will be different from the

It is important to sketch out a new paradigm for marginal costs, even though many of the calculations on which it could be constructed have not been developed.

current system in a number of ways. The theory is that it will be optimally sized with optimal technology, which should in most cases reduce costs (or at least societal costs reflecting environmental constraints) relative to current technology — although that may not always be true. However, the system would also be built at current construction costs, so it could be more expensive in that regard. Since TSLRIC represents an optimal system, it removes one of the key problems of the NERA method, which can disproportionately assign excess capacity to specific customer classes if not undertaken carefully to remove the excess capacity.

Although the theory is relatively easy to state, it has not been implemented for an electric utility, and the data to implement it will need to be collected and analyzed. To make this calculation, one needs to start with the cost of the existing system. This is then adjusted for inflation since the time when it was built, yielding what is usually referred to as “replacement cost new.” But a TSLRIC study goes beyond simply a study of the replacement cost of the system as it exists today. Other sources of data should be acquired for resources whose costs are declining due to technological change and data availability. From that point, one examines the changes in the generation resource mix to move it toward optimality. Substitution of storage or other DERs for upstream generation and transmission may reduce TSLRIC costs. A complex engineering analysis would also be required to review the magnitude of the cost-decreasing and cost-increasing drivers for transmission and distribution costs, which are likely to be different by utility. The discussion below outlines qualitative issues relating to the cost



changes that would result from using a system constructed under TSLRIC.

### 25.1.1 Generation

Without full quantification, an optimal system 15 to 20 years out will contain considerably more wind generation, solar generation, possibly some other renewable generation and more storage than the current system. The mix of solar and wind generation is likely to be region-specific, depending on available resources that can be economically brought to market. Some storage could be centralized, providing generation for peaking, ramping and renewable integration. At the grid level, storage could be related to batteries, compressed air and pumped hydro, as well as the load-related operations of large water projects (e.g., hydroelectric capacity and flexible pumping loads and storage associated with large water supply projects). The question of black start capability of storage resources may need to be addressed because, if storage can provide this capability, it may supplant the need for certain gas-fired resources.

Storage could be decentralized, also serving to reduce the need to build distribution capacity while serving the distribution system with greater reliability in addition to G&T displacement. At the decentralized level, batteries would be an option, but so would end-user storage such as controllable water heaters (which would have significant benefits for dealing with ramp), thermal energy storage to supplant peak air conditioning, and use of existing or new water storage to control timing of pumping and delivery by local water agencies and irrigators. This storage is a joint product that must be functionalized among generation, distribution and possibly transmission.

Controls on electric vehicle charging — to keep them out of peak periods, avoid distribution overloads, preferentially charge to mitigate ramp and possibly reverse flows (vehicle to grid) — could also create flexibility, since there would be little or no resource costs except controls (incremental changes in costs of charging and discharging only). These controls are installed at the end user level but may be critical to reduce generation and distribution costs in an optimal system and as such would be part of TSLRIC.

Other demand response programs beyond traditional

programs (such as interruptible industrials and air conditioner cycling) likely would become cost-effective as part of an optimal system. Examples include smart appliances that would run discretionary loads such as washing, drying or dishwashing at times when the loads match system needs, and variable-speed drives for heating, ventilation and air conditioning systems that could both save energy and respond automatically to peak or ramp conditions. These also may be part of TSLRIC, functionalized among generation, transmission and distribution as joint products.

Most existing conventional hydro and pumped storage resources probably would remain part of an optimal system, although the timing of their usage may change from the current system. In part, even under TSLRIC, it is not reasonable to ignore high decommissioning costs that can be avoided by keeping them in operation. More importantly, hydro resources with storage also provide energy at zero incremental costs, as well as ancillary services and significant amounts of flexibility to the grid. These resources may be devalued rather than being included at full replacement cost to recognize that their continued operation depends in part on avoiding the costs of removing them — which is generally not considered in a TSLRIC environment. However, some smaller resources would be closed, particularly run-of-river plants and those in areas where there are significant environmental impacts. At current and projected costs (considering those related to capital, operations and emissions), coal and traditional nuclear units<sup>237</sup> likely would not be part of the new optimal system under TSLRIC.

The role of natural gas-fired generation for reliability and bulk energy generation in an optimal system that recognizes carbon constraints is a large question. In all likelihood, some of the most efficient gas generating units would remain for a significant period, although the amount of energy they produce could be considerably less than at present. Gas plants could include:

- CHP, which has very high efficiency and uses thermal energy to produce steam for industrial processes or chilled water to displace air conditioning loads.

<sup>237</sup> Consider the abandonment of South Carolina Electric and Gas Co.'s Summer Nuclear Station and the cost overruns at Georgia Power's Vogtle units 2 and 3, which cost \$23 billion — or more than \$10,000 per kW (Ondieki, 2017).

- Combined cycle generation designed for flexible use that could also make up for any shortages in bulk energy if adverse weather conditions reduce output from hydro and renewables.
- Potentially, gas turbine peakers. The modern gas turbine supplanted less-efficient older gas-fired steam units. But storage and demand response are likely to make even modern gas turbines less economic, particularly for reserves, needle peak use and ramping.<sup>238</sup> Nevertheless, in some places, particularly where gas turbines are considerably cheaper than combined cycle units and where other flexible resources (such as hydro) are not widely available, there may be a dispatch range (for example, a 10% to 20% capacity factor) where gas turbines might be economic in an optimal system.

For any fossil generation, to the extent not otherwise internalized, a carbon adder based on residual damage or mitigation costs would be included under TSLRIC, but much of the TSLRIC system is being rebuilt to optimize for the need to reduce carbon emissions as well as for financial costs.

### 25.1.2 Transmission

Assuming no major technological advances (e.g., superconductors), some changes in transmission from the current system would arise from changing generation patterns. Long-distance transmission from existing coal and nuclear stations may no longer be part of an optimal system, but long-distance transmission from distant wind regions may replace it as a significant factor, either because of new construction or wheeling costs.<sup>239</sup> Interties would likely remain, although there may be more bidirectional power, and their role may be clearing renewable surpluses across wide regions. These transmission facilities for delivery of bulk energy, explicitly excluded from the NERA method, probably would be allocated over hours of use — making them energy-related, since they are not constructed for peak loads.

There may be other efficiencies associated with both better controls and with the possible use of strategically

located storage devices if cheaper than both transmission lines and conventional RMR gas-fired generation. PG&E's use of batteries to displace an RMR contract in an area south of San Jose (discussed in Section 18.3) suggests the potential of this outcome. It is also possible that a further analysis of a more optimal network of transmission lines may reveal significant portions of those lines are, in fact, related to off-peak use or contingencies that could occur at nonpeak times and should thus be spread over more than peak hours.

### 25.1.3 Shared Distribution

The whole distribution system would become part of TSLRIC, instead of just the narrowly defined portions where the NERA method suggests investments are needed to serve increases in demand. The optimal distribution system is likely to need less capacity and to serve load more reliably and with fewer losses than the current system, because of technologies such as automatic switching and integrated volt/VAR controls — which would reduce costs — and because energy efficiency (particularly related to space conditioning), decentralized storage, demand response and controls on electric vehicles could reduce distribution peaks.

There are likely to be customers for whom usage is so low that they are better served by DERs than by a grid. They will include many rural customers (particularly in areas with high potential fire danger) but also small loads in an urban area. Solar-powered school crossing signals are being installed today, simply because the cost of connecting to the grid exceeds the cost of the distributed energy system. Other applications using low-wattage LED lights (e.g., traffic signals and remote streetlights) may ultimately also find a distributed alternative to be cheaper than grid service. Factoring this into a TSLRIC study will ensure that low-use customers are not assigned costs that will not benefit them economically.

Distribution is also likely to be bidirectional at least in some places, particularly if whole neighborhoods are served with distributed solar (or solar plus storage) resources. This change may require more expensive control systems in some

<sup>238</sup> In 2018, NV Energy executed contracts for four-hour battery storage at a cost of \$73 per kW-year, less than the carrying cost plus nondispatch O&M for a peaker (Bade, 2018).

<sup>239</sup> For example, capacity freed up on transmission lines bringing coal-fired electricity from Four Corners to Southern California Edison is now being used to deliver wind energy from New Mexico. (Southern California Edison, 2015, p. 4).

places but is also likely to have a net effect of economizing on system sizing. Some primary distribution feeders (along with service lines and transformers) may need to be reconstructed if neighborhoods are converted from gas to electric space heating or if electric vehicles become ubiquitous, but those costs would be spread over more kWhs of load. Beneficial electrification of heating and transportation could increase total distribution costs, but because these technologies add energy loads, the costs per kWh may be stable or decline, and the amount of winter peaking load is likely to increase.

However, costs can increase from other aspects of the optimal distribution system. More of the optimal system is likely to be underground in urban areas, increasing system capital costs. Although overhead wires are cheaper, they also have nonmonetary costs related to worse aesthetics, poorer reliability (particularly in areas subject to ice storms and tropical storms) and to some extent worse safety (fires, downed wires). There would be some cost offset because the oldest and least reliable underground technologies that are currently being replaced at significant cost would have been supplanted, thereby reducing TSLRIC maintenance and replacement costs compared with current costs. Urban vegetation management costs would also be reduced in a system with more undergrounding. The overall costs of increased underground service (even after netting out the relevant costs avoided, such as maintenance, replacement of aging lines and vegetation management) likely would still be higher than current costs.

The optimal distribution grid is likely to have other cost-increasing features. It will need more resilience against natural disasters such as hurricanes, more patrols and maintenance to prevent fires, and costlier and more extensive vegetation management. It will also incur costs for protection against stronger winds, dealing with safety hazards from pole overloading by both electric utilities and communications companies, and possibly undergrounding in some remote areas to prevent outages and fires.

One potential outcome in the Western U.S. may even be that significant parts of the grid routinely begin to receive interruptible service to prevent wildfires. Even more remote portions of the grid serving few customers in areas with high fire danger may be completely abandoned. In essence, those parts of the system could be turned back

to individual customers who use solar and storage to serve their loads and establish small microgrids. They may possibly be some of the last customers with fossil fuels (propane or compressed natural gas) as a source for meeting relatively large energy loads such as space and water heating in a mainly decarbonized system.

#### **25.1.4 Customer Connection, Billing and Service Costs**

The design of customer connection equipment may not change greatly, except for replacement of urban overhead lines with underground equipment and possibly some advances in controls that can optimize transformer capacity for small customers. As noted earlier, some service lines and transformers may need to be resized if neighborhoods are converted from gas to electric space heating or electric vehicles become ubiquitous. As with the current system, costs of advanced metering would need to be divided between the pure connection and billing function and the costs of other services that AMI provides (to reduce grid costs and to provide platforms for demand response and storage behind the meter).

Customer accounting and service O&M will be reduced due to the continuation of greater productivity from internet and interactive voice response systems and the prevalence of cheaper methods of receiving and paying bills that were discussed in Section 21.4. These items have been increasing productivity for the last decade and are likely to continue to do so.

### **25.2 Hourly Marginal Cost Methods**

Although the hourly marginal cost method has not been explicitly used (a variant is used in Nevada), the Energy and Environmental Economics long-run marginal cost study points to how such a method could be used. Rather than dividing costs into demand and energy costs and allocating by kWhs, E3 assigns its various types of avoided costs to individual hours so that specific energy efficiency, demand response and distributed generation costs could be measured against the hourly costs given their operational patterns. When costs are assigned to hours, the allocation to classes can be based on customer loads in those hours without calling the

costs “demand” or “energy” costs. As with hourly allocation embedded cost methods, this may be an approach that will serve the cost analyst as the utility system evolves to include widespread renewable and distributed resources.

To convert the marginal costs calculated using a variant of the NERA method into hourly costs, and after considering the E3 hourly cost calculation, the following method could be used. This method still has some of the potential drawbacks of the NERA method discussed in detail above (possible mismatches in short-run and long-run analysis, failure to consider certain plant such as transmission interties, ambiguous treatment of replacement equipment, etc.). The NERA approach is also a fundamentally peak-oriented method, as opposed to the methods based on hours of use of capacity suggested in Chapter 17. Nevertheless, with some modification, it can be amenable to hourly calculations.

### 25.2.1 Energy and Generation

Energy costs can be calculated on a time period basis, as in Oregon or California. Otherwise, energy costs can be calculated on an hourly basis, as in Nevada, and aggregated into time periods based on hourly loads (including losses) by each class in each time period. Generation capacity costs need to be originally calculated in dollars per kW of capacity and divided between peaking capacity and other capacity needs (e.g., ramp) in ways described in Section 19.3. The peaking costs would be assigned to a subset of hours using methodologies such as loss-of-energy expectation, PCAF, loads or load differentials in largest ramp periods, or other multihour methods. Costs in each hour would then be calculated in cents per kWh and multiplied by the loads in each hour (including losses). The hourly costs can be aggregated into time periods. Consideration should be given to the establishment of a super-peak period for hourly cost allocation containing the highest peak-related costs based on loss-of-energy expectation or PCAF allocations to encourage the use of short-term resources such as demand response. If ramp costs are calculated, they could largely be based on storage operations and could have negative capacity costs in hours when storage is charging immediately before a ramp and positive capacity costs from the beginning of the ramp through the daily peak and shortly afterward.

### 25.2.2 Transmission and Shared Distribution

For transmission and distribution costs (except possibly for distribution costs for new business, including primary lines installed to connect new customers and transformers), a method that skips the dollars-per-kW step and goes directly to total dollars per hour has advantages. It avoids the significant problems associated with mismatches of kW of capacity (calculated based on extreme weather peak loads or size of equipment that is added) and kW of load (calculated based on a smaller number of kW such as PCAF or a peak or diversified demand); see Appendix C. This also provides a clearer path toward design of TOU pricing. If a figure in cents per kWh is needed in an hour or time period, total dollars can be divided by the loads in each hour. Such an allocation method would need to be disaggregated by voltage (transmission if not FERC jurisdictional, possibly subtransmission, distribution). Additionally, a disaggregation at each voltage between substations and circuits would improve an hourly calculation because substations and circuits may have different time patterns of usage and cost causation.

For each component (excluding the transmission components for utilities with fully FERC jurisdictional transmission), the total investment in capacity-related equipment including automation and controls — unlike the NERA method, which excludes them — would be calculated in real dollars and averaged over a period such as 10 years. This should perhaps include both forward-looking and historical data as with the NERA method. The costs should then be annualized using an RECC and with O&M and possibly replacements added (in real dollars per year). The O&M and replacement costs would be based on either averaged costs or forward-looking costs if changes from the average have been observed or are expected.

Substation capacity needs are generally oriented to the peak loads of the equipment, although they are also related to the duration of heavy energy use, suggesting a broader allocation than a single coincident peak. An allocation of total dollar costs to time periods consistent with the NERA method's emphasis on capacity could be based on some hybrid of the percentage of kVA of substation peaks in each season and time period and a PCAF, which has an energy component

because all loads in excess of 80% of the peak are assigned some capacity value. The PCAF could be set differently for summer and winter peaking kVA if applicable. For rate design purposes, a super-peak period could also be carved out that recognizes stress on components and high marginal line losses during extreme loads.

Transmission and subtransmission line marginal capacity under the NERA method involves a highly networked system, where at least some of the installed capacity is needed to meet contingencies that may occur at times other than during peak hours. The hourly causation and allocation of costs is likely to require further analysis that has not yet been conducted. But it could be some mix of peak loads (i.e., PCAF) and hourly loads (weighted into time periods when contingencies are most likely to occur to the extent possible).

Distribution substations are generally oriented to diversified peak loads on the equipment while also being related to the duration of energy use and should be allocated to hours in a manner like the allocation of transmission substations. Distribution lines are more radial in nature, although switching among feeders has been installed in some places, and more automation and volt/VAR controls are likely to cause distribution systems to become more networked. The cost causation for distribution line capacity has a peak-oriented component — which is likely to increase as the system networking and switching increases — and a component related to individual feeder peak loads, which is likely to decline. To allocate these costs to hours, one could start with a cost component for specific lines that would be directly assigned based on the individual peak of customers who are very large in relation to feeder sizes (i.e., customers over a particular MW size or a high percentage of the feeder's peak load). Remaining costs could be allocated to hours based on a mix of PCAF or top hours, a component based on the timing of individual feeder peaks (taking into account differences in residential and commercial load patterns) and a base load to all hours. For cost allocation, the hourly loads for feeder peaks could segregate the residential and commercial loads into

different hours. If large customers are directly assigned costs, they would not be allocated any of the hourly costs.

New business distribution lines could be part of distribution circuits or could be segregated into a separate cost item for allocation. If new business lines and line transformers are separated from other distribution costs, the costs could be calculated in dollars per kW using a method with a demand measure such as changes in the demand at the final line transformer<sup>240</sup> (which reflects diversity for those customers sharing transformers). These costs can then be allocated to hours within each class based partly on class peak load characteristics (e.g., assigning more costs to residential customers in summer evening hours or to commercial customers during summer afternoons) and partly to additional hours to reflect that transformer performance is degraded if more energy is used in high-load (nonpeak) hours, as discussed in Section 5.1. A class allocation based on loads at the transformer would reflect that these very localized costs have some relationship to the customer's own demand (diversified to the transformer). Some utilities may have a small secondary distribution marginal capacity component reflecting that capacity may need to be added to networked secondary systems. This cost, if applicable, could be treated similarly to new business and line transformer costs, assigned in dollars per kW based on demand at the final line transformer and assigned to classes on the secondary system in the same way as line transformers.

O&M costs for substations and circuits generally should be allocated in the same way as the plant, except that costs of vegetation management and various periodic patrols and inspections should be assigned to all hours because they are not caused by peak loads.

If T&D replacement costs are included as recommended in Chapter 20, the costs should be allocated to hours either in a manner like the underlying allocation for plant of each type or based on all hours, reflecting that replacements are not based on peak demand. Some mix of the two methods may also be used.

---

240 With an allocation to primary voltage customers based on maximum demand but excluding transformer costs.

## 26. Summary of Recommendations for Marginal Cost of Service Studies

**T**his chapter provides recommendations on two sets of issues: how to make incremental improvements to the predominantly used NERA method and how to work toward developing an hourly TSLRIC method, which has not yet been implemented.

### 26.1 Improving Marginal Cost Methods

Nine key items are distilled from Part IV as to how to improve marginal cost methods from the NERA method.

1. Analyze whether demand response can provide relief for the highest 20 to 50 hours of system load more cost-effectively than supply options, and substitute these costs for peak-hour costing if they are available and cost-effective.
2. Analyze whether grid-sized batteries are the least-cost capacity resource in the near term, instead of combustion turbine peakers, to meet the highest few hundred hours of system load — recognizing that they may take on a different role in the long term as systems become more heavily reliant on variable renewable generation. This is particularly important if reliability has a grid integration or ramping function as well as a peaking function in the relevant jurisdiction, because a battery can reduce ramp approximately twice as much as a generator of the same size and can smooth intermittent resource output better than a fossil-fueled plant.
3. Move toward long-run incremental costs for generation containing less carbon as a first step toward the TSLRIC method. Oregon uses 75% combined cycle and 25% solar in its long-run incremental cost. To the extent that it can be reasonably justified, a decarbonized long-run incremental cost would have storage for capacity, more renewables and less gas.
4. If the NERA-style short-run energy and generation capacity cost methods are used in the relevant jurisdiction, use a longer period of time for analyzing marginal energy costs than one to six years to deal with the mix of short-run and long-run costs currently used. Also ensure that carbon costs are included and a renewable portfolio standard adder is used if relevant to the jurisdiction. And examine whether pure capacity purchased from the market is cheaper than either a combustion turbine or battery for near-term application.
5. Make the definition of marginal costs more expansive for transmission and distribution to include automation, controls and other investments in avoiding capacity or increasing reliability, and consider including replacement costs.
6. Use the NCO method of calculating marginal customer costs. If replacement is included for any assets, a replacement rate should be based on actual experience, which would typically be less often than the accounting lifetime suggests.
7. Functionalize marginal costs in revenue reconciliation; use EPMC by function, not in total.
8. If demand costs are used, make sure that kW used to calculate marginal costs and kW used to allocate them are harmonized.
9. To the extent feasible, use an hourly method, such as the one E3 developed, to assign costs to hours and then to customer class loads. This avoids the need to separate costs into the demand and energy classification.

### 26.2 Moving Toward Broader Reform

TSLRIC will require both vision and research to be implemented for all utility functions. How a TSLRIC approach might look different from simply using replacement cost new

for existing facilities was sketched out in Section 25.1.

The first place where a TSLRIC approach could be used is for generation, where it could be built up from a lower-carbon long-run incremental cost. Other resources may also be available to assist in constructing the TSLRIC of generation. They include the low-carbon grid study for the Western grid and similar studies that build out potential future resource plans (Brinkman, Jorgenson, Ehlen and Caldwell, 2016, and Marcus, 2016). This is a data-intensive approach that will require envisioning and costing out future systems and determining the resilience of the cost estimates to various assumptions. TSLRIC for generation probably suggests starting with a “cost by hours of use” approach, since

there is only a limited amount of resources with fossil fuel that may not be dispatched in all hours. This means that price shapes based on short-run marginal cost may no longer make sense. This method would end up giving batteries and storage negative energy costs when they are charging and positive costs when discharging. Distributed generation would require functionalization.

Developing TSLRIC for transmission and distribution would require considerable amounts of engineering analysis to determine how the various cost drivers would work when developing a more optimal system and would likely involve a longer process.

## Works Cited in Part IV

- Bade, G. (2018, June 13). NV Energy 2.3-cent solar contract could set new price record. Utility Dive. Retrieved from <https://www.utilitydive.com/news/nv-energy-23-cent-solar-contract-could-set-new-price-record/525610/>
- Barker, D. (2014, January 31). Testimony on behalf of San Diego Gas & Electric. California Public Utilities Commission Application No. 14-01-027. Retrieved from [https://www.sdge.com/sites/default/files/RDW\\_Barker\\_SDGE\\_Testimony\\_0.pdf](https://www.sdge.com/sites/default/files/RDW_Barker_SDGE_Testimony_0.pdf)
- Bohrman, J. (2013, June 3). Testimony on behalf of NV Energy. Public Utilities Commission of Nevada Docket No. 13-06-002. Retrieved from [http://pucweb1.state.nv.us/PDF/AxImages/DOCKETS\\_2010\\_THRU\\_PRESENT/2013-6/26978.pdf](http://pucweb1.state.nv.us/PDF/AxImages/DOCKETS_2010_THRU_PRESENT/2013-6/26978.pdf)
- Brinkman, G., Jorgenson, J., Ehlen, A., and Caldwell, J. (2016). *Low carbon grid study: Analysis of a 50% emission reduction in California* (NREL/TP-6A20-64884). Golden, CO: National Renewable Energy Laboratory. Retrieved from <https://www.nrel.gov/docs/fy16osti/64884.pdf>
- California Public Utilities Commission. (1983). Decision No. 83-12-068 in Pacific Gas & Electric general rate case, 14 CPUC 2d 15.
- California Public Utilities Commission. (1986, August 20). Decision No. 86-08-083 in 1986 energy cost adjustment charge case, 21 CPUC 2d 613.
- California Public Utilities Commission. (1989, December). Decision No. 89-12-057 in Pacific Gas & Electric general rate case.
- California Public Utilities Commission. (1995, December). Decision No. 95-12-053 in Pacific Gas & Electric biennial gas cost allocation proceeding.
- California Public Utilities Commission. (2018, November 8). Resolution E-4949 approving Pacific Gas & Electric battery procurements with modifications. Retrieved from <http://docs.cpuc.ca.gov/PublishedDocs/Published/G000/M240/K050/240050937.PDF>
- Chaudhury, S. (2015, November 19). Testimony on behalf of Southern California Gas Co. and San Diego Gas & Electric. California Public Utilities Commission Application No. 15-07-014. Retrieved from [https://www.socalgas.com/regulatory/documents/a-15-07-014/TCAP%20Phs%202%20-%20Chaudhury%20Revised%20\(clean\).pdf](https://www.socalgas.com/regulatory/documents/a-15-07-014/TCAP%20Phs%202%20-%20Chaudhury%20Revised%20(clean).pdf)
- Chow, L., and Brant, S. (2018). *The 2017 resource adequacy report*. California Public Utilities Commission, Energy Division. Retrieved from <http://www.cpuc.ca.gov/RA/>
- Goodman, I., and Marcus, W. (1990, July 23). Joint testimony on behalf of Concerned Citizens of Manitoba, Sierra Club of Western Canada, Manitoba Branch, and Conservation Strategy Association of Manitoba. Manitoba Public Utilities Board proceeding regarding Manitoba Hydro submission in respect to major capital projects.
- Horii, B., Price, S., Cutter, E., Ming, Z., and Chawla, K. (2016). *Avoided costs 2016 interim update*. Energy and Environmental Economics Inc. Retrieved from [https://www.ethree.com/wp-content/uploads/2017/01/20160801\\_E3\\_-\\_Avoided\\_Cost-2016-Interim\\_Update.pdf](https://www.ethree.com/wp-content/uploads/2017/01/20160801_E3_-_Avoided_Cost-2016-Interim_Update.pdf)
- Jones, G., and Marcus, W. (2015, March 13). Testimony on behalf of The Utility Reform Network. California Public Utilities Commission Application No. 14-06-014.



- Jones, G., and Marcus, W. (2016, July 5). Testimony on behalf of Utility Consumers' Action Network. California Public Utilities Commission Application No. 15-04-012.
- Lazar, J. (2016). *Teaching the "duck" to fly* (2nd ed.). Montpelier, VT: Regulatory Assistance Project. Retrieved from <https://www.raponline.org/knowledge-center/teaching-the-duck-to-fly-second-edition/>
- Maloney, P. (2018, July 3). PG&E to replace 3 gas plants with world's biggest battery projects. *Utility Dive*. Retrieved from <https://www.utilitydive.com/news/pge-to-replace-3-gas-plants-with-worlds-biggest-battery-projects/526991/>
- Marcus, W. (1984, September 21). Testimony on behalf of Cogentrix. North Carolina Utilities Commission Docket No. E-100, Sub 41A. Retrieved from <https://starw1.ncuc.net/NCUC/ViewFile.aspx?Id=d91cce39-c161-4dfb-b1d4-56677499106f>
- Marcus, W. (1988, September). *Electric utility planning for the 1990s* [Presentation for the Ontario Legislature Select Committee on Energy].
- Marcus, W. (2010a, February 26). Testimony and exhibits on behalf of the Arkansas attorney general. Arkansas Public Service Commission Docket No. 09-084-U. Retrieved from [http://www.apscservices.info/pdf/09/09-084-u\\_151\\_1.pdf](http://www.apscservices.info/pdf/09/09-084-u_151_1.pdf) and [http://www.apscservices.info/pdf/09/09-084-u\\_152\\_1.pdf](http://www.apscservices.info/pdf/09/09-084-u_152_1.pdf)
- Marcus, W. (2010b, October 6). Testimony on behalf of The Utility Reform Network. California Public Utilities Commission Application No. 10-03-014.
- Marcus, W. (2010c, October 12). Testimony on behalf of the Bureau of Consumer Protection. Public Utility Commission of Nevada Docket No. 10-06-001/-002. Retrieved from [http://pucweb1.state.nv.us/PDF/AxImages/DOCKETS\\_2010\\_THRU\\_PRESENT/2010-6/4649.pdf](http://pucweb1.state.nv.us/PDF/AxImages/DOCKETS_2010_THRU_PRESENT/2010-6/4649.pdf)
- Marcus, W. (2016). *Low carbon grid study: Comparison of 2030 fixed costs of renewables, efficiency, and integration with production cost savings*. JBS Energy.
- National Economic Research Associates. (1977a). *A framework for marginal cost-based time-differentiated pricing in the United States*. Palo Alto, CA: Electric Power Research Institute.
- National Economic Research Associates. (1977b). *How to quantify marginal costs*. Palo Alto, CA: Electric Power Research Institute. Palo Alto, CA: Electric Power Research Institute.
- New York Independent System Operator. (n.d.). *Installed capacity market (ICAP)* [Webpage]. Retrieved from <https://www.nyiso.com/installed-capacity-market>
- Ondieki, A. (2017, December 21). Georgia PSC votes to continue construction at Plant Vogtle. *The Atlanta Journal-Constitution*. Retrieved from <https://www.ajc.com/news/local-govt-politics/georgia-psc-votes-continue-construction-plant-vogtle/Tu0ja76KWtR3YGhaFLTeM/>
- Pacific Gas & Electric. (2016, December 2). *2017 generation rate case Phase II updated and amended prepared testimony*. California Public Utilities Commission Application No. 16-06-013. Retrieved from [https://drpwwg.org/wp-content/uploads/2017/07/PGE-09-v1\\_GRC-2017-PhII\\_Test\\_PGE\\_20161202\\_396470.pdf](https://drpwwg.org/wp-content/uploads/2017/07/PGE-09-v1_GRC-2017-PhII_Test_PGE_20161202_396470.pdf)
- Paice, C. (2013, March 1). Testimony on behalf of PacifiCorp. Public Utility Commission of Oregon Docket No. UE 263. Retrieved from <https://edocs.puc.state.or.us/efdocs/UAA/ue263uaa11547.pdf>
- Phillips, N. (2018, March 23). Testimony on behalf of Energy Producers and Users Coalition. California Public Utilities Commission Docket No. 17-06-030.

PJM. (n.d.). *Capacity market (RPM)* [Webpage]. Retrieved from <https://www.pjm.com/markets-and-operations/rpm.aspx>

Pollard, T. (2010, June 1). Testimony on behalf of NV Energy. Public Utility Commission of Nevada Docket No. 10-06-001. Retrieved from [http://pucweb1.state.nv.us/PDF/AxImages/DOCKETS\\_2010\\_THRU\\_PRESENT/2010-6/1869.pdf](http://pucweb1.state.nv.us/PDF/AxImages/DOCKETS_2010_THRU_PRESENT/2010-6/1869.pdf)

Public Utilities Commission of Nevada. (2002, March 29). Dockets No. 01-10001 and 01-10002, order in Nevada Power Co. general rate case. Retrieved from [http://pucweb1.state.nv.us/PDF/AxImages/DOCKETS\\_2001\\_THRU\\_2004/2001-10/7107.pdf](http://pucweb1.state.nv.us/PDF/AxImages/DOCKETS_2001_THRU_2004/2001-10/7107.pdf)

Public Utilities Commission of Nevada. (2007, July 17). Dockets No. 06-11022 and 06-11023, modified final order in Nevada Power Co. general rate case. Retrieved from [http://pucweb1.state.nv.us/PDF/AxImages/DOCKETS\\_2005\\_THRU\\_PRESENT/2006-11/12604.pdf](http://pucweb1.state.nv.us/PDF/AxImages/DOCKETS_2005_THRU_PRESENT/2006-11/12604.pdf)

Saxe, W. (2012, March 30). Testimony on behalf of San Diego Gas & Electric. California Public Utilities Commission Application No. 11-10-00. Retrieved from [https://www.sdge.com/sites/default/files/Saxe\\_Revised\\_Testimony\\_Ch\\_3\\_FINAL%2520\\_Second%2520Revised\\_\\_0.pdf](https://www.sdge.com/sites/default/files/Saxe_Revised_Testimony_Ch_3_FINAL%2520_Second%2520Revised__0.pdf)

Saxe, W. (2016, February 9). Testimony on behalf of San Diego Gas & Electric. California Public Utilities Commission Application No. 15-04-012. Retrieved from [https://www.sdge.com/sites/default/files/Saxe%2520Clean%2520w\\_Attachments.pdf](https://www.sdge.com/sites/default/files/Saxe%2520Clean%2520w_Attachments.pdf)

Schichtl, J. (2002, October). Revenue allocation testimony on behalf of Southern California Edison. California Public Utilities Commission Application No. 02-05-004.

Southern California Edison. (2014, June 20). *Phase 2 of 2015 general rate case: Marginal cost and sales forecast proposals*. California Public Utilities Commission Application No. 14-06-014. Retrieved from [http://www3.sce.com/sscc/law/dis/dbattach5e.nsf/0/CA145802C8F9719A88257CFD0073857B/\\$FILE/A.14-06-XXX\\_2015%20GRC%20Phase%20%20-%20SCE-02%20Marginal%20Cost%20and%20Sales%20Forecast.pdf](http://www3.sce.com/sscc/law/dis/dbattach5e.nsf/0/CA145802C8F9719A88257CFD0073857B/$FILE/A.14-06-XXX_2015%20GRC%20Phase%20%20-%20SCE-02%20Marginal%20Cost%20and%20Sales%20Forecast.pdf)

Southern California Edison. (2015, October 27). Advice Letter No. 3299-E. Retrieved from <https://cpucadviceletters.org/search/?source=&q=3299-E&submit=>

Southern California Edison. (2017a, July 7). *2018 general rate case Phase 2 workpapers*. California Public Utilities Commission Application No. 17-06-030. Retrieved from <http://www3.sce.com/law/cpucproceedings.nsf/frmMainPage?ReadForm>

Southern California Edison. (2017b, November 1). *Errata to Phase 2 of 2018 general rate case: Marginal cost and sales forecast proposals*. California Public Utilities Commission Application No. 17-06-030. Retrieved from [http://www3.sce.com/sscc/law/dis/dbattach5e.nsf/0/F40D6AEFD8622526882581CB007FC097/\\$FILE/A1706030-%20SCE-02A-2018%20GRC%20Ph2-Various-Errata%20Marginal%20Cost%20and%20Sales%20Forecast.pdf](http://www3.sce.com/sscc/law/dis/dbattach5e.nsf/0/F40D6AEFD8622526882581CB007FC097/$FILE/A1706030-%20SCE-02A-2018%20GRC%20Ph2-Various-Errata%20Marginal%20Cost%20and%20Sales%20Forecast.pdf)

Strunk, K. (2018, October 15). *Marginal cost of distribution service: Prepared for Central Maine Power Company* (Exhibit Strunk-2). Maine Public Utility Commission Docket No. 2018-00194. Retrieved from <https://mpuc-cms.maine.gov/CQM.Public.WebUI/Common/CaseMaster.aspx?CaseNumber=2018-00194>

Walsh, L. (2013, June 3). Testimony on behalf of NV Energy. Public Utilities Commission of Nevada Docket No. 13-06-002. Retrieved from [http://pucweb1.state.nv.us/PDF/AxImages/DOCKETS\\_2010\\_THRU\\_PRESENT/2013-6/26978.pdf](http://pucweb1.state.nv.us/PDF/AxImages/DOCKETS_2010_THRU_PRESENT/2013-6/26978.pdf)

Xcel Energy. (2018, October 2-4). *Leading the energy future* [Presentation at the Wolfe Research Conference]. Retrieved from [investors.xcelenergy.com/file/4025308/Index?KeyFile=1500113448](https://investors.xcelenergy.com/file/4025308/Index?KeyFile=1500113448)

# **Part V: After the Cost of Service Study**

## 27. Using Study Results to Allocate the Revenue Requirement

Ultimately, the purpose of a cost of service study is to inform utility regulators about the relative contribution to costs by the various customer classes as one element in the decision on how to apportion the revenue requirement among classes. In most states, regulators have a great deal of discretion about how they use the results of cost allocation studies. Therefore, the way the results are presented is important because the regulators will want to see important impacts clearly to use their time efficiently.

Embedded cost of service studies and marginal cost of service studies approach this very differently, and we discuss each separately in this chapter. After that, we discuss approaches regulators use to implement, or diverge from, the results of these studies.

### 27.1 Role of the Regulator Versus Role of the Analyst

The role of the regulator is different from that of the analyst. Regulators typically are appointed or elected into the position based upon their broad perspectives of what “fair, just and reasonable” means in the context of utility regulation and pricing. These perspectives are necessarily subjective.

The analyst, on the other hand, may be tempted to work on a strictly scientific and mathematical basis. This may not adequately serve the needs of the regulator, who may need the analysis to take note of public policy goals, economic conditions in the service territory and other factors.

In the simplest terms, the regulator may need a range of reasonable options for cost allocation and for rate design, based on a range of reasonable analytical options, not a single recommendation based on a single framework or approach. The analyst must be prepared to develop more than one cost allocation study, based on more than one analytical approach, and let the regulator consider the principles guiding each study. The analyst must be prepared to develop multiple approaches to rate design, all sharing the same goals of overall revenue recovery and efficient forward-looking pricing.

### 27.2 Presenting Embedded Cost of Service Study Results

Embedded cost of service studies typically include conclusions regarding the relative margin to the utility from each customer class. Relative margin is a measure of profitability, based on the revenues, expenses and rate base allocated to each class.<sup>241</sup> Class profitability is often presented in the following forms:

1. Calculated rate of return on rate base (expressed both by class and for the total utility):

$$\text{rate of return} = \frac{\text{allocated annual operating income}}{\text{allocated rate base}}$$

Where allocated annual operating income =  
annual revenues – annual allocated expenses

2. Calculated utility profit margin (expressed both by class and for the total utility):

$$\text{profit margin} = \frac{\text{annual revenues}}{\text{annual allocated expenses}} - 1$$

3. Ratio of class revenue to total class-allocated costs:

$$\text{revenue ratio} = \frac{\text{revenues}}{\text{allocated expenses} + \text{allocated return}}$$

Where allocated return = allocated rate base × allowed rate of return

4. Revenue shortfall:

$$\text{shortfall} = (\text{allocated return} + \text{allocated expenses}) - \text{current revenues}$$

5. Percentage increase required for equal rate of return:

$$\text{increase for equal rate of return} = \frac{\text{shortfall}}{\text{revenues}}$$

Table 45 on the next page shows an illustrative example of the computation of these measures.

<sup>241</sup> These computations may use historical revenues and costs or projected revenues and costs.

**Table 45. Computing class rate of return in an embedded cost study**

	Total	Residential	Small (up to 20 kW)	Medium (20 to 250 kW)	Large (more than 250 kW)	Large primary	Other
<b>Revenues</b>	\$117,760,688	\$28,116,419	\$8,342,138	\$26,156,458	\$38,730,796	\$15,134,759	\$1,280,117
<b>Allocated expenses</b>	\$112,438,805	\$28,297,246	\$8,997,362	\$23,807,377	\$35,927,265	\$14,280,041	\$1,129,515
<b>Operating income</b>	\$5,321,883	-\$180,827	-\$655,223	\$2,349,081	\$2,803,532	\$854,718	\$150,603
<b>Allocated rate base</b>	\$87,878,094	\$24,935,855	\$8,339,503	\$18,481,728	\$26,069,711	\$9,399,629	\$651,667
<b>Allocated return</b>	<b>\$5,321,883</b>	<b>\$1,510,111</b>	<b>\$505,039</b>	<b>\$1,119,251</b>	<b>\$1,578,778</b>	<b>\$569,240</b>	<b>\$39,465</b>
<b>Rate of return</b>	6.06%	-0.73%	-7.86%	12.71%	10.75%	9.09%	23.11%
<b>Profit margin</b>	4.52%	-0.65%	-7.82%	8.94%	7.21%	5.62%	13.33%
<b>Revenue-cost ratio</b>	100.00%	94.33%	87.79%	104.93%	103.27%	101.92%	109.51%
<b>Revenue shortfall (or surplus)</b>		\$1,690,938	\$1,160,262	(\$1,229,831)	(\$1,224,754)	(\$285,478)	(\$111,138)
<b>Percentage increase for equal rate of return</b>		6.01%	13.91%	-4.70%	-3.16%	-1.89%	-8.68%

Note: Independent rounding may affect results of calculations.

To the extent that the results of the cost of service study are reliable, the class rates of return indicate which classes are paying more or less than the average return. In the example in Table 45, the rate of return results show that the utility is earning less than the average return from the residential class and the small general service class and more than average from the other classes. These class rate of return results do not provide much information about the size of the revenue shift that would produce equal rates of return (or any class-specific differential return requirement), or whether a negative rate of return represents a very serious situation.

The profit margin, while commonly used in many industries, ignores the return on capital. The revenue-cost ratio provides a more intuitive metric. The most useful results may be the revenue shortfall and the increase required to produce class return equal to the system average return.

These metrics show a very different picture of interclass equity. The residential class may be providing a negative rate of return, -0.73% in Table 45, but its revenues are equal to 94.33% of the system revenue requirement. Because of uncertainties in sampled load data, variation in load patterns among years and the difficulty of defining the causation of many costs, regulators define a “range of reasonableness” of one or more of the profitability metrics. For example, if the

regulator considered reasonable the range of revenue-cost ratio from 93% to 107%, it is possible a regulator might find that the residential class is producing a reasonable level of revenue but that small general service customers should be paying a somewhat higher share of system costs than 87.79% and the “other” class (which might be mostly street lighting) should be paying somewhat less than 109.51%.

The cost allocation process usually assumes that all classes and all assets impose the same cost of capital. The results in Table 45 reflect that assumption, effectively stating that an equal return is the goal. In some cases, the regulator may determine that different customer classes impose different financing costs in percentage terms — for example, to reflect the higher undiversifiable risks of serving industrial loads through the economic cycle. In addition, some assets are riskier than others; generation is generally riskier than T&D, while nuclear and coal generation are often regarded as being riskier than other generation. In this situation, the cost of service study could be modified to reflect the differential risks (different required rates of return can be applied to different classes of customers or different categories of utility plant). Or the cost of service study results could be presented in a manner that allows the user to compare the achieved return to the class target return.

To summarize, presenting embedded cost of service study results in multiple ways is often helpful to regulators. The revenue-cost ratio is probably the easiest way for regulators to understand and use the results of cost of service studies in determining the fair, just and reasonable apportionment of costs. It is important to note that the result of this allocation process is to determine a level of revenue that the regulator deems cost-related. The regulator will often apply other non-cost criteria to establish the level of revenue that each customer class will pay.

## 27.3 Presenting Marginal Cost of Service Study Results

Marginal cost of service studies reach a very different set of conclusions than embedded cost of service studies. While an embedded cost of service study divides up the allowed revenue requirement among classes, a marginal cost of service study measures (over a short-, intermediate- or long-run time frame) the costs that would change as customer count and usage change.

A marginal cost of service study produces a cost for each increment of service: the cost of connecting additional customers, peak capacity at different levels of the system and energy costs by time period. These can be multiplied by

**Table 46. Illustrative marginal cost results by element**

	Units	Cost per unit
<b>Customer connection</b>	Dollars per year	\$80
<b>Secondary distribution</b>	Dollars per kW	\$40
<b>Primary distribution</b>	Dollars per kW	\$80
<b>Transmission</b>	Dollars per kW	\$50
<b>Generation capacity</b>	Dollars per kW	\$100
<b>Energy by time period</b>		
On-peak	Dollars per kWh	\$0.10
Midpeak	Dollars per kWh	\$0.07
Off-peak	Dollars per kWh	\$0.05

customer usage to generate a marginal cost revenue requirement for each class. Table 46 shows an illustrative marginal unit cost result.

Table 47 shows load research data for an illustrative utility system with three classes with identical kWh consumption but different per-customer usage and very different load shapes. The residential class and secondary commercial class both take power at secondary voltages, but the secondary commercial class has a more peak-oriented usage and 10 times the average consumption per customer.

**Table 47. Illustrative load research data for marginal cost of service study**

	Units	Residential	Secondary commercial	Primary industrial
<b>Customer connection</b>	# of customers	100,000	10,000	1,000
<b>Secondary distribution</b>	kWs	300,000	320,000	N/A
<b>Primary distribution</b>	kWs	303,000	325,000	250,000
<b>Transmission</b>	kWs	305,000	325,000	255,000
<b>Generation capacity</b>	kWs	307,000	330,000	258,000
<b>Energy by time period</b>				
On-peak	kWhs	245,600,000	396,000,000	206,400,000
Midpeak	kWhs	614,000,000	825,000,000	825,000,000
Off-peak	kWhs	614,000,000	252,600,000	442,200,000
All periods	kWhs	1,473,600,000	1,473,600,000	1,473,600,000
<b>Class load factor</b>		55%	51%	65%

**Table 48. Illustrative marginal cost revenue requirement**

	Residential	Secondary commercial	Primary industrial	Total
<b>Customer connection</b>	\$8,000,000	\$800,000	\$80,000	\$8,880,000
<b>Secondary distribution</b>	\$12,000,000	\$12,800,000	N/A	\$24,800,000
<b>Primary distribution</b>	\$24,240,000	\$26,000,000	\$20,000,000	\$70,240,000
<b>Transmission</b>	\$15,250,000	\$16,250,000	\$12,750,000	\$44,250,000
<b>Generation capacity</b>	\$30,700,000	\$33,000,000	\$25,800,000	\$89,500,000
<b>Energy by time period</b>				
On-peak	\$24,560,000	\$39,600,000	\$20,640,000	\$84,800,000
Midpeak	\$42,980,000	\$57,750,000	\$57,750,000	\$158,480,000
Off-peak	\$30,700,000	\$12,630,000	\$22,110,000	\$65,440,000
<b>Total</b>	<b>\$188,430,000</b>	<b>\$198,830,000</b>	<b>\$159,130,000</b>	<b>\$546,390,000</b>
<b>Average marginal cost per kWh</b>	<b>\$0.128</b>	<b>\$0.135</b>	<b>\$0.108</b>	<b>\$0.124</b>

The primary industrial class has a less peak-oriented usage and 100 times the average consumption per customer of the residential class.

Table 48 combines the marginal costs by element with the load research data to compute a marginal cost revenue requirement for each class, as well as the combined total.

As shown in Table 48, the illustrative MCRR for all classes combined is \$546,390,000. It would be pure happenstance if this equaled the embedded cost revenue requirement determined in the rate case. More likely, the revenue requirement will be significantly more or less. The next step in a marginal cost of service study is reconciliation between the MCRR results and the establishment of class-by-class responsibility for the embedded cost revenue requirement.

There are two commonly used methods to reconcile

the class marginal cost responsibility, as determined by a marginal cost of service study, to the utility embedded cost revenue requirement determined in the rate proceeding. The first method is equal percentage of marginal cost, which itself has two variants. The second is the inverse elasticity rule derived from Ramsey pricing. The approaches are very different.

In the EPMC approach, the embedded cost revenue requirement is compared with the total of the class marginal cost revenue requirements, also known as the system MCRR. For example, we offer two possible situations in tables 49 and 50 — one where the marginal cost is less than the revenue requirement, the other where it is more — and show the result of adjusting the revenue for each class by a uniform percentage. The class marginal cost revenue requirements

**Table 49. EPMC adjustment where revenue requirement less than marginal cost**

	Residential	Secondary commercial	Primary industrial	Total
<b>Marginal cost revenue requirement</b>	\$188,430,000	\$198,830,000	\$159,130,000	\$546,390,000
<b>Embedded cost revenue requirement</b>				\$500,000,000
<b>Ratio of embedded cost to marginal cost</b>				92%
<b>Reconciled revenue requirement</b>	\$172,431,779	\$181,948,791	\$145,619,429	\$500,000,000

**Table 50. EPMC adjustment where revenue requirement more than marginal cost**

	Residential	Secondary commercial	Primary industrial	Total
<b>Marginal cost revenue requirement</b>	\$188,430,000	\$198,830,000	\$159,130,000	\$546,390,000
<b>Embedded cost revenue requirement</b>				\$600,000,000
<b>Ratio of embedded cost to marginal cost</b>				110%
<b>Reconciled revenue requirement</b>	\$206,918,135	\$218,338,549	\$174,743,315	\$600,000,000

are adjusted by the ratio of the embedded cost revenue requirement to the system MCRR, resulting in the amount of the embedded cost revenue requirement that each class is responsible for. In Table 49, the cost responsibility for each class is reduced 8% below the marginal cost of service.

It is important to note that the result of this allocation process is to determine a level of revenue that the regulator deems cost-reflective. The regulator often will apply other non-cost criteria to establish the level of revenue that each customer class will pay.

The EPMC is often functionalized, particularly in

jurisdictions where power supply is a competitive non-utility service. Assume for purposes of the illustration in Table 50 that the total embedded cost revenue requirement of \$600 million comprises \$400 million of generation costs, \$60 million of transmission costs and \$140 million of distribution costs. Table 51 shows how to reconcile costs for each function separately, which are then used to calculate the overall responsibility of each class for the embedded cost revenue requirement.

The illustrative functionalized EPMC results in Table 51 are close to the total EPMC results but slightly higher for

**Table 51. Illustrative functionalized equal percentage of marginal cost results**

	Residential	Secondary commercial	Primary industrial	Total
<b>Distribution</b>				
Customer connection	\$8,000,000	\$800,000	\$80,000	\$8,880,000
Secondary distribution	\$12,000,000	\$12,800,000	N/A	\$24,800,000
Primary distribution	\$24,240,000	\$26,000,000	\$20,000,000	\$70,240,000
Marginal cost revenue requirement	\$44,240,000	\$39,600,000	\$20,080,000	\$103,920,000
Embedded cost revenue requirement				\$140,000,000
Reconciled distribution revenue requirement	\$59,599,692	\$53,348,730	\$27,051,578	
<b>Transmission</b>				
Marginal cost revenue requirement	\$15,250,000	\$16,250,000	\$12,750,000	\$44,250,000
Embedded cost revenue requirement				\$60,000,000
Reconciled transmission revenue requirement	\$20,677,966	\$22,033,898	\$17,288,136	
<b>Generation</b>				
Capacity	\$30,700,000	\$33,000,000	\$25,800,000	\$89,500,000
Total energy	\$98,240,000	\$109,980,000	\$100,500,000	\$308,720,000
Marginal cost revenue requirement	\$128,940,000	\$142,980,000	\$126,300,000	\$398,220,000
Embedded cost revenue requirement				\$400,000,000
Reconciled generation revenue requirement	\$129,516,348	\$143,619,105	\$126,864,547	
<b>Total reconciled revenue requirement</b>	<b>\$209,794,006</b>	<b>\$219,001,733</b>	<b>\$171,204,261</b>	<b>\$600,000,000</b>



**Table 52. Total EPMC results with lower marginal generation costs**

	Residential	Secondary commercial	Primary industrial	Total
<b>Marginal cost revenue requirement</b>	\$133,170,000	\$137,240,000	\$103,720,000	\$374,130,000
<b>Embedded cost revenue requirement</b>				\$600,000,000
<b>Ratio of embedded cost to marginal cost</b>				160%
<b>Reconciled revenue requirement</b>	\$213,567,476.55	\$220,094,619.52	\$166,337,903.94	\$600,000,000

residential and slightly lower for primary industrial customers.

However, if the marginal generation costs are considerably lower, functionalization can have a different impact. Assume that marginal energy costs are half of the estimates in Table 48 and marginal generation capacity costs are 80% of those in Table 48 (e.g., because of low gas prices, a shorter time horizon for cost estimation and excess capacity). These results are shown in tables 52 and 53.

As shown in Table 53, functionalization blunts the impact of lower marginal generation costs. Compared with Table 52,

the residential class actually has a lower share of the embedded cost revenue requirement under functionalization with lower marginal generation costs. Table 54 on the next page compares the results for the residential class from tables 50, 51, 52 and 53.

Comparing the two functionalization scenarios, the residential share of embedded costs ends up very slightly higher in the lower marginal generation scenario, but the difference is less than 1%.

The second general approach used for marginal cost of service study application is the inverse elasticity rule.

**Table 53. Functionalized EPMC example with lower marginal generation costs**

	Residential	Secondary commercial	Primary industrial	Total
<b>Distribution</b>				
Customer connection	\$8,000,000	\$800,000	\$80,000	\$8,880,000
Secondary distribution	\$12,000,000	\$12,800,000	N/A	\$24,800,000
Primary distribution	\$24,240,000	\$26,000,000	\$20,000,000	\$70,240,000
Marginal cost revenue requirement	\$44,240,000	\$39,600,000	\$20,080,000	\$103,920,000
Embedded cost revenue requirement				\$140,000,000
Reconciled distribution revenue requirement	\$59,599,692	\$53,348,730	\$27,051,578	
<b>Transmission</b>				
Marginal cost revenue requirement	\$15,250,000	\$16,250,000	\$12,750,000	\$44,250,000
Embedded cost revenue requirement				\$60,000,000
Reconciled transmission revenue requirement	\$20,677,966	\$22,033,898	\$17,288,136	
<b>Generation</b>				
Capacity	\$24,560,000	\$26,400,000	\$20,640,000	\$71,600,000
Total energy	\$49,120,000	\$54,990,000	\$50,250,000	\$154,360,000
Marginal cost revenue requirement	\$73,680,000	\$81,390,000	\$70,890,000	\$225,960,000
Embedded cost revenue requirement				\$400,000,000
Reconciled generation revenue requirement	\$130,430,165	\$144,078,598	\$125,491,237	\$400,000,000
<b>Total reconciled revenue requirement</b>	<b>\$210,707,823</b>	<b>\$219,461,226</b>	<b>\$169,830,951</b>	<b>\$600,000,000</b>

**Table 54. Residential embedded cost responsibility across four scenarios**

	High generation marginal costs	Low generation marginal costs
<b>Total EPMC results</b>	\$206,918,135	\$213,567,477
<b>Functionalized EPMC results</b>	\$209,794,006	\$210,707,823

As discussed in Chapter 24, it is based on Ramsey pricing, an economic theory that efficiency is enhanced when the elements of the rate that are “elastic” with respect to price are set equal to some measure of marginal cost, and that adjustments to reconcile the revenue requirement should be applied to the least elastic component or components in order to maximize economic efficiency. This approach was popular during the era when marginal costs were significantly higher than average costs reflected in the revenue requirement.<sup>242</sup> For that reason, we show the application of the inverse elasticity rule only for a situation where the revenue requirement is lower than system marginal costs.

The least elastic element of utility service is often deemed to be the connection to the grid: the customer-related component of costs such as billing and collection, and the secondary service lines to individual structures. Evidence suggests this to be true historically. Whether utilities assess a monthly customer charge of \$5 or \$35, nearly all residences and

businesses subscribe to electric service, although customer charges likely influence decisions whether to master-meter multifamily buildings, accessory dwelling units and offices. Economists generally agree that price more significantly influences actual customer usage of kW and kWhs.

This may become significantly different where customers have more feasible choices to disconnect from the grid or obtain some services from on-site generation and storage. For example, pedestrian crossing signals often are now being installed with solar panels and batteries, without any connection to the grid. This phenomenon potentially could extend to larger users, depending on the levels of monthly customer charges, usage-related charges, and solar and storage costs.

Table 55 shows a marginal cost reconciliation of the same costs in Table 49 but by first reducing the customer and secondary costs by class and then applying an EPMC adjustment to the residual class marginal costs until the revenue requirement is reached.

In this illustrative example, the residential class benefits substantially and the secondary commercial class benefits somewhat compared with the straightforward application of the EPMC method in Table 49. As a result, the primary industrial class ends up paying a larger share of the overall embedded cost revenue requirement.

**Table 55. Use of inverse elasticity rule**

	Residential	Secondary commercial	Primary industrial	Total
<b>Marginal cost revenue requirement</b>	\$188,430,000	\$198,830,000	\$159,130,000	\$546,390,000
<b>Customer connection costs</b>	\$8,000,000	\$800,000	\$80,000	
<b>Secondary distribution costs</b>	\$12,000,000	\$12,800,000	N/A	
<b>Adjusted marginal cost revenue requirement</b>	\$168,430,000	\$185,230,000	\$159,050,000	\$512,710,000
<b>Embedded cost revenue requirement</b>				\$500,000,000
<b>Ratio of embedded cost to adjusted marginal cost</b>				98%
<b>Reconciled revenue requirement</b>	\$164,254,647	\$180,638,178	\$155,107,176	\$500,000,000

<sup>242</sup> Until the early 1980s, for example, Oregon excluded customer and joint costs from the marginal cost reconciliation process on the theory that these were highly inelastic components of customer demand — to simply

be connected to the system. When overall rates rose and later costs declined, Oregon moved to an EPMC approach (Jenks, 1994, p. 12).

## 27.4 Gradualism and Non-Cost Considerations

This section discusses the methods regulators use to reach a decision on the fair apportionment of the revenue requirement based on both cost and non-cost considerations. Regulators frequently depart from the strict application of cost of service study results. Often, regulators reject the studies that are presented due to inclusion of one or more allocation factors they find unacceptable. A common example is the use of the minimum system method to measure a customer-related share of electric or gas distribution system costs; many regulators have found this methodology as unacceptable today as Bonbright did in 1961. In many cases where multiple studies are presented, the regulator may choose a result that reflects the “range of reasonableness” these studies suggest. In many cases where regulators do accept the results of a specific cost of service study, they may choose to move only gradually in the direction of the accepted study results.

It is quite common for regulators to consider the results of multiple cost of service studies in determining an equitable allocation of costs among customer classes. This can occur in various ways:

- Considering multiple embedded cost of service studies or marginal cost of service studies using different classification or allocation methods, to determine a range of reasonableness.
- Considering both embedded cost of service studies as an indicator of current costs and marginal cost of service studies as an indicator of cost trajectories in setting a reasonable cost allocation.

For example, in one docket, the Washington Utilities and Transportation Commission compared results of four cost of service studies before making a decision on cost allocation, with the results shown in Table 56 (1984, p. 46).<sup>243</sup>

Table 56. Consideration of multiple cost of service studies

Source of study	Revenue as percentage of revenue requirement by class			
	Residential	Small general service	Large general service	Extra large general service
<b>Utility</b>	91%	113%	110%	108%
<b>Industrial advocate</b>	91%	112%	110%	110%
<b>Consumer advocate</b>	93%	115%	105%	104%
<b>Low-income advocate</b>	97%	113%	103%	99%

Source: Washington Utilities and Transportation Commission. (1984). Cause U-84-65, third supplemental order in rate case for Pacific Power

Based on multiple studies using widely different methodologies for the classification and allocation of generation, transmission and distribution costs, the commission was able to determine a fair allocation of the revenue requirement responsibility, taking into account specific elements within each study where it ruled for or against those elements. The end result of multiple studies produced a range of reasonableness in the allocation of costs. The commission adjusted revenues gradually toward the common result of the studies: that residential customers were paying slightly less than their share of costs and that small and large general service customers were paying slightly more than their share.

Gradualism is the movement only partway toward the results of cost of service studies in apportioning the revenue requirement based on an accepted cost study. If a cost of service study indicates that a class is paying much less than its fair share of the revenue requirement, immediately moving it to pay its full share of allocated costs may result in excessive financial pain and dislocation for the affected customers. Regulators sometimes impose generic limits on rate changes (such as limiting the increase for any class to 150% of the system average increase) and often impose ad hoc limits, based on the facts of the case.<sup>244</sup>

243 Similarly, the Wisconsin Public Service Commission has routinely reviewed multiple cost of service studies and selected a revenue allocation without specifically relying on any one study. See Wisconsin Public Service Commission (2016, pp. 31-32): “As a result, the Commission finds that it is reasonable to continue its long-standing practice of relying on multiple models, as well as other factors, such

as customer bill impacts, when determining the final allocation of the revenue requirement.”

244 Where this sort of guideline takes the form of “no class will be assigned more than twice the rate increase applied to any other class,” it is known as 2:1 gradualism.

There are several reasons a regulator will move gradually, including:

- To avoid rate shock on any individual customer class. Rate shock is often defined as a rate increase of more than 5% or 10% at any one rate adjustment. There is no firm standard, but many regulators hesitate to impose a rate adjustment that upsets the budgets of households or businesses. If an accepted cost of service study (or group of studies) suggests that one class should receive a 15% rate increase while others require no increase, a regulator may reasonably determine to spread the rate increase across all classes in a way that avoids rate shock within any one.
- To recognize that the cost of service study is a snapshot and that costs and cost responsibility may shift over time. The allocation of cost may vary significantly from one year to another because of factors such as fluctuating weather (which may change the peakiness of load, shift highest loads from summer to winter or dramatically change irrigation pumping loads). Under these circumstances, shifting revenue requirements back and forth among classes in each rate proceeding will not improve equity. Unnecessary volatility in prices may confuse customers, complicate budgeting and create unnecessary political and public-relations problems.
- To avoid overcorrecting a temporary imbalance in revenue responsibility, in recognition that technology is evolving and the cost structure will be different in the future. Cost of service studies measure costs based only on either test-year results of operations (embedded cost of service studies) or an estimate of future costs (marginal cost of service studies) at the time they are produced. Costs change dramatically over time as fuel costs change, new technologies become available and older assets shift to new roles. For example, the study may reflect the costs of legacy steam-electric generation scheduled for retirement in the next few years, to be replaced by demand response measures and distributed storage, which will also have T&D benefits.
- To avoid perceptions of inequity and unfairness. Bonbright (1961) identified perceptions of equity and

fairness as a core principle of rate design, but they represent an overwhelmingly subjective metric. Many regulators, for example, have declined to reduce rates for any customer class in the context of an overall increase but may apply a lower increase to some classes than others. This is a matter of judgment, so this manual cannot provide any policy guidance on the right approach.

Each of these factors may represent a reasonable basis for deviating from precise recovery from each customer class of its full allocated cost. Legislatures generally grant regulators a great deal of flexibility in determining rates that are fair, just and reasonable and expect them to consider such factors in their decisions.

In addition to the principles of gradualism discussed in this section, many regulators consider non-cost factors in determining a fair apportionment of costs, including:

- Retention of load that cannot (or will not) pay for its fully allocated cost but can pay more than its incremental cost and thus can reduce the revenue requirement borne by other classes. Examples include electric space heat customers in summer-peaking utilities, irrigation customers in winter-peaking utilities and industrial customers facing global competition. Utilities frequently develop load retention tariffs to keep those customers on the system, contributing to paying off embedded costs. Charging full embedded cost to those tariff classes could result in higher, not lower, bills for other customers if the price-sensitive customers depart the system.

The objective in those cases is to maximize the benefits to the customers paying full cost, without any particular concern about the interest of the class paying the reduced rate. If faced with the potential loss of a major industry, a regulator may opt to offer a rate significantly below the cost basis that would otherwise apply. Some, for example, have relied on an embedded cost of service study to determine the general allocation of costs among classes but relied on a short-run marginal cost of service study to determine a “load retention” or “economic development” rate to retain or attract a major customer. This is often done in recognition that failure to do so would

- result in the loss of sales, not to mention broader harms (e.g., increased unemployment) to the jurisdiction. The loss of sales could trigger a difficult regulatory decision on whether to apportion the surplus capacity that results among the remaining customers or to impose a regulatory disallowance on the utility, forcing utility investors to absorb the stranded asset costs.
- Serving loads that would otherwise impose higher environmental costs of alternative fuels. Examples include shore-service rates to discourage ships from running their high-emitting onboard generation while in port, special rates to displace on-site diesel generation and special rates for irrigators that would otherwise use diesel-powered pumps.
  - Protection of vulnerable customers, for their own sake. Utilities, regulators and even legislatures seek to reduce the burden on groups of customers that are financially stressed. Most frequently, the target group is low-income residential customers, but the same approach is applied in some places for agricultural customers, important employers facing competition from outside the service territory and the like.
- It is beyond the scope of this manual to attempt to identify the entire variety of non-cost factors a regulator may consider. The process of cost allocation does not occur in a vacuum but rather in the context of broader social and political currents.

## 28. Relationship Between Cost Allocation and Rate Design

As indicated at the outset, cost allocation is the second of three steps in the rate-making process, beginning with the determination of the revenue requirement and ending with the design of rates. This manual has been careful to explain that these are separate phases of a proceeding and may have separate principles that apply, and the results may not always flow neatly from one phase to the next.

At its heart, cost allocation is about equity among customer classes — providing an analytical basis for assigning the revenue requirement to the various classes of customers on a system. This may be done strictly on the basis of an analytical cost of service study or, more often, using quantitative cost of service studies as a starting point, with broader considerations including gradualism, economic impacts on the service territory and attention to changes anticipated in future costs.

Rate design has a different set of goals. Rates must be sufficient to provide the utility with an opportunity to recover the authorized revenue requirement, but rate design is also about equity among customers within a class and about understandable incentives for customers to make efficient decisions about their consumption that will affect future long-term costs. It is common for a regulator to use a backward-looking embedded cost allocation method and a forward-looking rate design approach that considers where cost trajectories will go. Rate design can also incorporate public policy objectives, including environmental and public health requirements. In *Smart Rate Design for a Smart Future* (Lazar and Gonzalez, 2015), RAP articulated three principles for modern rate design:

- Principle 1: A customer should be able to connect to the grid for no more than the cost of connecting to the grid.
- Principle 2: Customers should pay for grid services and power supply in proportion to how much they use these

At its heart, cost allocation is about equity among customer classes. Rate design has a different set of goals.

services and how much power they consume.

- Principle 3: Customers that supply power to the grid should be fairly compensated for the full value of the power they supply.

These principles provide guidance on how to modernize rate design, in conjunction with the traditional considerations of customer bill impacts and understandability.

### 28.1 Class Impacts Versus Individual Customer Impacts

The data used to examine changes in overall costs and bills for rate design are often much more granular, among types of customers, than data used for cost allocation.

Most cost allocation studies group customers into a relatively small number of classes for analysis. This is done for analytical simplicity, to provide the regulator a general guide to cost responsibility among the classes. Some do this grouping by voltage level, some by type of customer (e.g., residential vs. commercial vs. irrigation), but nearly all utilities have more individual tariffs than classes examined in the cost of service study. For example, “residential” may be a single class in the cost of service study, but separate tariffs may apply to single-family, multifamily, electric heating, electric water heating and electric vehicle loads. A utility may have a default rate design (e.g., inclining block) and one or more optional rate designs (e.g., TOU or seasonal customers). “Secondary general service” may be a single class in the cost of service study including all secondary voltage business customers that are nonresidential but will include urban commercial retail and office customers, as well as rural agricultural customers.

It is common to have separate rate tariffs that focus on the usage by specific groups of customers to enable them to control their bills by focusing their attention on elements of their consumption they can easily manage. A cost of service study provides broad guidance on how costs should be apportioned among customer classes. The result may be a uniform percentage allocation of a rate increase (or decrease) or one that is differentially apportioned among the customer classes.

The class definitions for cost allocation typically look at large groups of customers with similar service characteristics. Rate design often looks at smaller groups of customers with similar usage characteristics or even individual customers. For example, a shift of rate design from an inclining block rate to a time-varying rate may result in sharp increases in the bills for some customers with low usage.

The municipal utility for Fort Collins, Colorado, encountered this situation in its 2018 rate review and included a “tier charge” for all usage over 700 kWhs in part to avoid this kind of impact. The cost of service study did not contain sufficient detail to provide an analytical framework for this decision, but the rate design analysis showed that apartment residents and other small users would be adversely affected without this consideration of customer impacts. Similarly, when the Arizona Corporation Commission adopted inclining block rates in the 1980s for Arizona Public Service Co., it also created optional residential TOU and demand-charge rates to provide a pathway for larger residential users to avoid sharp bill impacts by shifting usage to lower-cost periods.

## 28.2 Incorporation of Cost Allocation Information in Rate Design

It is often the case that the information developed in the process of cost allocation is relevant to important issues in rate design. In most states, embedded cost of service studies are used to allocate costs among customer classes,<sup>245</sup> but regulators consider long-run marginal costs, either implicitly or explicitly, in designing rates within classes. The Washington Utilities and Transportation Commission stated in adopting an embedded cost framework that it wanted to be looking ahead in some parts of the rate-making process:

In order to obtain forward-looking embedded costs which are required by the generic order, it is necessary to use historical cost for allocation to production plant and other categories, followed by a classification method which recognizes the current cost relationships between baseload and peak facilities (1982, p. 37).

This mix of embedded cost principles for cost allocation and marginal cost principles for rate design reflects a sense of balance between the notions of equity of overall cost allocation between classes and efficiency of rates applied within classes. Even in states where the embedded cost of service study does not contain any time differentiation of generation, transmission or distribution costs, regulators have adopted time-varying retail rates for many classes of customers to encourage behavior expected to reflect forward-looking and avoidable costs.

Although marginal cost of service studies typically do differentiate between time periods, even these studies provide limited guidance for rate design, simply because the factors that affect utility system design and construction may not be understandable to consumers. The core principles from Bonbright and many others — that rates be simple, understandable and free from confusion as to calculation and application — remain important, no matter what the results of a cost study may suggest. As a result, further refinements to this information may be necessary to apply in rate design.

Many analysts who still use legacy cost allocation techniques or otherwise problematic methods argue that this analysis is relevant to rate design. In most cases, this is doubling down on a mistake. For example, use of the minimum system method for determination of residential customer charges is a mistake because it greatly overstates the cost of connecting a customer to the grid. However, some

---

<sup>245</sup> As discussed in Section 6.1, there is a direct relationship between an embedded cost of service study and the revenue requirement, which makes it an analytically convenient method of dividing the revenue requirement. Using a marginal cost of service study for cost allocation requires additional adjustments to ensure the correct amount of revenue will be recovered.

states allow use of the minimum system method for cost allocation between classes but require the narrower basic customer method for the determination of customer charges within classes in the rate design process.

## 28.3 Other Considerations in Rate Design

Regulators often include non-cost considerations in the design of rates. This is an appropriate exercise of their responsibility to ensure that rates are fair, just and reasonable. These terms are, by their nature, subjective, with ample room to include considerations other than electric utility costs in the ultimate decisions. For example, the Washington Utilities and Transportation Commission has stated:

We recognize the substantial elements of judgment which are involved in the development of any cost of service study. We also recognize that many factors beyond an estimate of cost of providing service are important in the design of rates. These factors ... include acceptability of rate design to customers; elasticities of demand, or the variation of demand when prices change; perceptions of equity and fairness; rate stability over time; and overall economic circumstances within the region.

Based upon all these factors, we believe it is necessary to make some movement toward the cost of service relationships which the respondent has presented, although we do not believe that it is appropriate to fully implement the study in this proceeding. For policy reasons, including those stated above, we do not feel it necessary to infer that any cost of service study should be automatically or uncritically accepted and applied in rate design (1981, p. 24).

Some jurisdictions also explicitly incorporate broader societal costs, particularly environmental and public health externalities, into rate design decisions. In Massachusetts, the Department of Public Utilities has longstanding principles of efficiency that include: “The lowest-cost method of fulfilling consumers’ needs should also be the lowest-cost means for society as a whole. Thus, efficiency in rate structure means

that it is cost-based and recovers the cost to society of the consumption of resources to produce the utility service” (Massachusetts Department of Public Utilities, 2018, p. 6).

These types of broader policy priorities can be reflected in many ways. For example, a state with a policy to encourage customer-owned renewable energy supply may develop rates that are favorable to customers with solar panels. A state with a policy to encourage energy conservation may have an additional reason to adopt inclining block rates. A state with real or perceived peak load limitations may prefer a critical peak pricing rate.

One very common public policy goal is the use of postage stamp rates, with the same rates applying to all customers of a class within a service territory. As discussed in Section 5.2, there are trade-offs in terms of the number of customer classes. A larger number of customer classes may capture more cost-based distinctions than a smaller number. For example, in most utility systems, multifamily customers that are less expensive to serve pay the same rates as single-family customers, and rural customers pay the same rates as urban. Having separate customer classes to reflect these distinctions would arguably lead to a much more equitable distribution of costs. These are probably the largest deviations from cost principles in today’s utilities — dwarfing other deviations such as perceived undercharging of residential customers as a class or of solar customers as a subclass.

However, additional customer classes can lead to additional administrative and oversight costs. Furthermore, regulators, utilities and stakeholders must all have confidence that there are true cost differentials among the customer types and that there will be little controversy in applying these differentials. Some analysts object to customer classes based on adoption of particular end uses, although this may serve as a proxy for significantly different usage profiles. Some analysts may prefer separate classes for distinct types of customers, such as schools and churches. As discussed previously, rates that automatically reflect cost distinctions (e.g., time-varying rates or different residential customer charges for single-family and multifamily) can accomplish the same objective as the creation of additional customer classes, often with



additional efficiency benefits from improved pricing.

Proper data must be available to all parties so they can scrutinize the distinctions made between customer classes and whether these are truly based on cost and not improper motives like price discrimination. Some analysts feel that a smaller number of rate classes will be fairer on balance, and many equity issues within a customer class can be dealt with through rate design.

Other common non-cost considerations come into play in designing rates for low- and limited-income consumers. In an engineering sense, these customers may differ very little from other residential consumers in the metrics typically used in a cost of service study. But regulators, on their own initiative or under direction from their legislatures, may adopt non-cost-based discounts for these customers.

Proper data must be available so all parties can scrutinize whether distinctions made between customer classes are based on cost and not improper motives like price discrimination.

The same non-utility cost principles often apply to special rates for new industrial customers to encourage economic development within a service territory.

Lastly, in some states, legislatures have dictated some elements of rate design, constraining the discretion of the commission. In Connecticut and California, statutory limitations on residential customer charges dictate, respectively, the basic customer method<sup>246</sup> and a cap of \$10 a month adjusted for inflation.<sup>247</sup>

<sup>246</sup> See Connecticut General Statutes, Title 16, § 16-243bb, limiting the residential fixed charge to "only the fixed costs and operation and maintenance expenses directly related to metering, billing, service connections and the provision of customer service."

<sup>247</sup> California Public Utilities Code § 739.9(f).

## Works Cited in Part V

Bonbright, J. (1961). *Principles of public utility rates*. New York, NY: Columbia University Press.

Jenks, B. (1994, September). *The incredible, disappearing residential exchange benefit*. Oregon Citizens' Utility Board.

Lazar, J., and Gonzalez, W. (2015). *Smart rate design for a smart future*. Montpelier, VT: Regulatory Assistance Project. Retrieved from <https://www.raonline.org/knowledge-center/smart-rate-design-for-a-smart-future/>

Massachusetts Department of Public Utilities. (2018, January 5). Docket No. 17-05, order establishing Eversource's rate structure. Retrieved from <https://fileservice.eea.comacloud.net/FileService.Api/file/FileRoom/9170110>

Washington Utilities and Transportation Commission. (1981). Cause U-81-41, second supplemental order in rate case for Puget Sound Power and Light Co.

Washington Utilities and Transportation Commission. (1982). Cause U-82-10, second supplemental order in rate case for Washington Water Power.

Washington Utilities and Transportation Commission. (1984). Cause U-84-65, third supplemental order in rate case for Pacific Power.

Wisconsin Public Service Commission. (2016, December 22). Docket No. 6680-UR-120, final decision in rate case for Wisconsin Power and Light Co. Retrieved from [http://apps.psc.wi.gov/vs2015/ERF\\_view/viewdoc.aspx?docid=295820](http://apps.psc.wi.gov/vs2015/ERF_view/viewdoc.aspx?docid=295820)

## Conclusion

Cost allocation is a complex exercise dependent on sound judgment. No less an authority than the U.S. Supreme Court has made this point:

A separation of properties is merely a step in the determination of costs properly allocable to the various classes of services rendered by a utility. But where, as here, several classes of services have a common use of the same property, difficulties of separation are obvious. Allocation of costs is not a matter for the slide-rule. It involves judgment on a myriad of facts. It has no claim to an exact science.<sup>248</sup>

These words from Justice William Douglas are just as applicable today as they were when written in 1945. What has changed since 1945 are the facts, which in turn require new judgments. In particular, advancements in technology have had a great impact and reverberating effects on our power system. Multiple aspects of our power system are continuing to evolve, and cost allocation methods must change to reflect what we are experiencing. Over the past few decades, key changes in the power system that have consequences on how we allocate costs include:

- Renewable resources are replacing fossil-fueled generation, substituting invested capital in place of variable fuel costs.
- Peaking resources are increasingly located near load centers, eliminating the need for transmission line investment to meet peak demand served by peaking units. Long transmission lines are often needed to bring not only baseload coal and nuclear resources but also wind and other renewable resources, even if they may have limited peaking value relative to their total value to the power system.
- Advanced battery storage is a new form of peaking resource — one that can be located almost anywhere on the grid and has essentially no variable costs. The total costs of storage still need to be assigned to the time

period when the resource is needed, to ensure equitable treatment of customer classes.

- Consumer-sited resources, including solar and storage, are becoming essential components of the modern grid. The distribution system may also begin to serve as a gathering system for power flowing from locations of local generation to other parts of the utility service territory, the opposite of historical top-down electric distribution.
- Short-run variable costs are generally diminishing as capital and data management tools are substituted for fuel and labor.

Simply stated, this means that many of the cost allocation methods used in the previous century are not appropriate to the electric utilities of tomorrow. As we've discussed in this manual, new methods, new metrics and new customer class definitions will be needed. The role of the cost analyst remains unchanged: We are assigned the task of determining an equitable allocation of costs among customer classes. The methods analysts used in the past must give way to new methods more applicable to today's grid, today's technologies and today's customer needs.

This manual has identified current best practices in cost allocation methodology. These will also need to evolve to keep up with the technological changes our electric system is experiencing. Perhaps the most important evolution in methodology recognizes that utility grids are built for the general purpose of providing electricity service. The largest single cost of building the grid is to ensure that it provides kWhs to customers during all hours of the day and night. Thus, similar to the way we price gasoline, groceries and clothing, most costs of the grid should be assigned on a usage basis, recovered in the sale of each kWh. In this same context, the cost of connecting to the grid may be a customer-specific cost. For items such as groceries and clothing, customers bear

---

<sup>248</sup> Colorado Interstate Gas Co. v. Federal Power Commission, 324 U.S. 581, 589 (1945).

the cost of “connecting to the grid,” by traveling to a retailer. The balance of the “grid” cost can and should be recovered in the price of each unit.

As we have noted in this manual, a variety of cost allocation methods are currently in use across the country. There are certain changes in cost allocation methodology that will be specific to the approach appropriate for different regions. However, this manual identifies certain changes in methodology that will be of general application across the continent, including:

- Assigning costs to time periods of usage (such as critical peak, on-peak, midpeak, off-peak and super-off-peak), rather than the much coarser metrics of “demand” and “energy” used in the past.
- Differentiating among types of generation, recognizing that some are relied on during peak periods, while others are relied on during all hours or some other subset of hours during the year.
- Considering that the utilization of some utility assets may have changed. Plants that were built as baseload units may now be operated only intermittently, as newer resources with different cost characteristics become more valuable to the grid.
- Realizing that most utility assets serve shared customer loads, with different customers using these at different times. The application of time-differentiated cost analysis to apportioning the costs of a shared system becomes critical.
- Recognizing that smart grid systems make it possible to provide better service at lower cost by including targeted energy efficiency and demand response measures to meet loads at targeted times and places, and thus that those costs must, to some extent, follow the savings they enable.

Embedded cost of service modeling practices must also be modified to account for new changes in the electric system. Key in this is the need to consider each asset and

resource for the purposes for which it was constructed and the functions it provides today. In general, assets that serve in all hours should have their costs assigned to all hours; those that serve only in limited periods, or are upsized at additional cost for certain periods, should have costs assigned to the relevant periods. The traditional methods of defining costs as customer-related, demand-related and energy-related must give way to time-varying purposes, so costs can be fairly assigned among time periods in the new era.

Not surprisingly, marginal cost methods also must change. Although these are used in fewer states than embedded cost methods, they also need significant changes to be relevant in the modern electric industry environment. Methods must be updated to recognize both (1) the substitution of capital costs for short-run variable operating costs and (2) DER solutions for generation, transmission and distribution.

Whether the cost allocation method has changed or not, it is always important to present cost allocation data clearly, so that regulators can do their job. Most regulators expect quality technical analysis of costs but apply judgment in the application of those results. They may want to consider the results of multiple studies using different methods. Gradualism in the implementation of change has important value to avoid sudden impacts that may devastate residential, commercial or industrial customers. Data and analytical results should be presented in a way that informs regulators. We must still recognize, however, that “allocation of costs is not a matter for the slide-rule,” as Justice Douglas wrote nearly a century ago.

This manual attempts to define methods that are relevant today and will be applicable into the future as the industry continues to evolve and as technology continues to drive changes in costs, investment and expenses. The reasoned analyst will always need to apply creativity and skill to the task of allocating costs.

# Appendix A: FERC Uniform System of Accounts

Since about 1960, the Federal Energy Regulatory Commission has required electric utilities to follow its Uniform System of Accounts. The system has accounts for both a utility's balance sheet and its income statement.<sup>249</sup>

The balance sheet accounts include 100 to 299, with 300 to 399 providing more detail on utility plant and accounts 430 to 439 providing more detail on retained earnings. Income statement accounts are 400 to 499, excepting 430 to 439. Many of the accounts relevant to utility rate case filings and cost of service studies are identified below.

## 100 to 199: Assets and Other Debits

The asset accounts include plant in service (Account 101) and depreciation reserve (Account 108) — which constitute plant in rate base — and construction work in progress (Account 107), along with a number of smaller accounts.

In most states, not all of these accounts are in rate base,<sup>250</sup> but the ones that typically are include:

- Accounts receivable other than from customers (Account 143).
- Fuel inventories (accounts 120 — nuclear, 151 and 152).
- Emissions allowances inventories (Account 158).
- Materials and supplies inventories (Account 154).
- Prepayments (Account 165, for items such as postage and insurance and in some cases pensions).
- Certain deferred debits (Account 182, especially regulatory assets for which the utility has invested money but not recovered it).

- Deferred tax assets (Account 190, usually netted with accounts 282 and 283).

## 200 to 299: Liabilities and Other Credits

The liability accounts (200 series) have some accounts traditionally in rate base and some not.

The largest elements included as offsets that reduce rate base are accumulated deferred income tax liabilities (accounts 282 and 283). In addition, rate base reductions come from:

- Customer deposits (Account 235, in most but not all states).
- Customer advances for construction (Account 252).<sup>251</sup>
- Deferred credits (regulatory liabilities, in Account 254).
- Unfunded pension liabilities (no specific account).

Elements of the amount of debt and equity, including discounts on issuance and amounts arising from refinancing past debt, are included in the capital structure, while most accounts payable are subsumed in the cash working capital computation.

## 300 to 399: Plant Accounts

The accounts in the 300 series are plant-in-service accounts (providing more detail into utility plant included in Account 101, by type). The accounts are subdivided for electric service<sup>252</sup> into:

Accounts 301 to 303: intangible plant. Today, the costs cover mostly computer software, although there are some

249 The information here comes from Title 18, Part 101 of the Code of Federal Regulations. Retrieved from <https://www.ecfr.gov/cgi-bin/text-idx?c=ecfr&SID=054f2bfd518f9926aac4b73489f11c67&rgn=div5&view=text&node=18:1.0.1.3.34&idno=18>. For a useful summary, see Phan, D. (2015, August). *Uniform System of Accounts* [Presentation for NARUC]. Retrieved from <https://pubs.naruc.org/pub.cfm?id=53720E26-2354-D714-5100-3EBD02A2034E>

250 Most states use a cash working capital calculation that encompasses the utility's accounts receivable and accounts payable for utility service (not always uniformly) so that these items are not in rate base directly but are included in the cash working capital calculation. Arkansas is an exception,

so this general discussion does not apply. Arkansas' modified balance sheet approach puts most of the asset items in rate base and most of the liabilities (200-series accounts) in the capital structure as zero-cost capital.

251 Unlike customer advances for construction, contributions in aid of construction do not have a specific place in the Uniform System of Accounts but are simply subtracted from the amount of plant included in summary Account 109 and the detailed accounts 364 to 370.

252 The 300-series accounts used for gas, water and so on are different from the electric accounts.

legacy items for paying for franchises. These costs are usually included with general and common plant as an overhead in cost allocation.

Accounts 310 to 317: steam production plant. These costs include costs of coal, oil and gas steam plants; some utilities include combined cycle steam turbines here. Biomass and geothermal plants owned by utilities would also appear here. Most utilities maintain records of these accounts to the level of the power plant, if not the individual unit of each plant, which are reported in each utility's annual report to FERC (FERC Form 1), although they may be summarized in cost of service studies.

Accounts 320 to 326: nuclear plant. Again, utilities maintain separate records for each nuclear plant or unit, which are presented in FERC Form 1.

Accounts 330 to 337: hydroelectric plant. Utilities generally maintain separate records for each hydro plant, which are also required to be filed as part of FERC Form 1. Pumped storage is included with other hydroelectric plant.

Accounts 340 to 347: other power generation. These include a mix of combustion turbines, combined cycles (as some utilities place entire combined cycles in these accounts), reciprocating engines, and wind and solar generation owned by the utility.

Account 348 is for energy storage plant with a generation function, excluding pumped hydro. This is a new addition to the Uniform System of Accounts and includes batteries, flywheels, compressed air and other storage.

Asset retirement obligations are included in each of the broad categories of production plant (accounts 317, 326 and 347). Asset retirement obligations are not included in rate base and are not directly found in cost of service studies. Aside from nuclear power plants (where they are related to the decommissioning fund), these costs only appear indirectly through the calculation of negative net salvage as part of depreciation.

Accounts 350 to 357: transmission accounts. Costs are divided by type of plant, not by the function or voltage level of plant. Account 351 is a recently added account for energy storage plant used on the transmission system.

Accounts 360 to 374: distribution accounts. Of the major accounts, 362 is distribution substations, 364 is poles,

365 overhead wires, 366 underground conduit, 367 underground wires, 368 line transformers (also including capacitors and voltage regulators), 369 services (sometimes divided into overhead and underground subaccounts), 370 meters, 371 installations on customer premises (usually lighting excluding streetlights but may include demand response equipment) and 373 streetlights. Account 363, used very infrequently now, is the FERC account where energy storage plant installed on the distribution system would be included.

Accounts 382, 383 and 389 to 399: general plant or common plant.

Accounts 382 and 383 are for general plant (largely computer systems) used in regional market operations, particularly for utilities that are members of ISOs.

Accounts 389 to 399 include land, buildings, furniture, computer hardware, vehicles and other similar items. Items at specific power plant sites can be allocated with the plant. Others are part of overhead costs. For an electric and gas utility, some items in these accounts can be "electric general plant" (items used at a power plant site, for example), while others are the portion of "common plant" allocated to the electric department of an electric and gas utility. General plant can also be allocated from a holding company serving a number of utilities.

#### **400 to 499: Income and Revenue Accounts**

Account 403 (depreciation) and Account 405 (amortization) are subdivided at least by type of plant (different types of production plant, transmission, distribution and general). Many utilities subdivide this further by the FERC plant accounts and by individual power plant or unit.

Account 408 (taxes other than income) is subdivided into accounts for property taxes, payroll taxes and other taxes (usually a small amount).

Current and deferred income taxes are found in accounts 409 and 410 and are usually calculated with significant detail in revenue requirement studies.

The remainder of these accounts do not appear directly in rate cases. Account 426 is noteworthy because it includes nonoperating expenses such as fines and penalties, lobbying, donations and so on. Revenue requirement analysts often try

to assess whether costs booked to operating accounts instead belong in this account.

Accounts 433 and 436 to 439 are retained earnings accounts. These accounts, which reflect profits not distributed to shareholders as dividends, do not appear in rate cases.

Accounts 440 to 449 are revenue accounts, using broad customer classes developed by FERC (residential, commercial, industrial, railways, other public authority and sales for resale). These FERC accounts often do not correspond to utility rate classes in a cost allocation study.

Accounts 450 to 456 are revenues that do not come from rates or wholesale transactions. They include late payment charges (Account 450), tariffed service charges (mostly in Account 451), rents (Account 453) and other revenues (Account 456).

### **500 to 599: Production, Transmission and Distribution Expenses**

Production expenses are divided similarly to plant and are broken down at the level of individual plants in FERC Form 1.

Steam production operating expenses are in accounts 500 to 509, and maintenance expenses are in accounts 510 to 514.

Nuclear production operating expenses are accounts 517 to 527, and nuclear maintenance expenses are in accounts 528 to 532.

Hydroelectric production expenses are in accounts 535 to 540, and hydro maintenance expenses are in accounts 541 to 545.

Other production plant expenses are in accounts 546 to 550, and other maintenance expenses are in accounts 551 to 554. Again, the definition includes combustion turbines, wind and solar, as above.

Purchased power is in Account 555; production load dispatching is in Account 556; and miscellaneous production expenses (e.g., power procurement administration, renewable energy credits) are in Account 557.

Transmission operating expenses are in accounts 560 to 567; maintenance expenses are in 568 to 573. Of note, wheeling expenses (transmission by others) are in Account 565, and certain expenses paid to ISOs under FERC tariffs are included as subaccounts of Account 561.

Regional market expenses are in accounts 575 (operating) and 576 (maintenance). The bulk of these costs are expenses paid to ISOs under FERC tariff and some internal market monitoring and similar costs.

Distribution operating expenses follow plant and are in accounts 580 to 590. Corresponding maintenance expenses are in accounts 591 to 598.

### **600 to 899: Accounts Reserved for Gas and Water Utilities**

Not discussed further.

### **900 to 949: Customer Accounts; Customer Service and Information, Sales, and General and Administrative Expenses**

Customer accounting expenses are accounts 901 to 905. Accounts 901 and 905 are generalized expenses, while Account 902 is meter reading. Account 903 is the catchall, including sending bills, collecting money, credit, call centers and similar items. Account 904 is uncollectible accounts expense.

Customer service and information expenses are accounts 907 to 910. Energy efficiency and demand response costs are typically found in Account 908, and Account 909 is instructional advertising.

Sales and marketing expenses are accounts 911 to 916. They include an advertising component in Account 913.

Administrative and general expenses are accounts 920 to 935. There are elements for administrative salaries (920) and nonlabor expenses (921) and contracts (923), as well as insurance (924 and 925), pensions and benefits (926), regulatory commission expenses (928), miscellaneous expenses (930) and rental of buildings and maintenance of general plant (931 to 935). They may include costs from holding companies. Costs in Account 922 are transferred out, either to capital or to other utility affiliates.

In these areas, the FERC Uniform System of Accounts is not particularly uniform. For example, the costs for the same function, such as a key account representative, can appear in accounts 903, 908, 912 or administrative account 920, depending on the utility. Generation procurement expenses, which appear to belong in Account 557, can also end up in the administrative accounts 920 and 921.

## Appendix B: Combustion Turbine Costs Using a Real Economic Carrying Charge Rate<sup>253</sup>

A real economic carrying charge (RECC) rate is designed to measure the economic return expected for an asset whose value increases at the rate of inflation every year. An economic carrying charge also has the property of measuring the value of deferring the construction of an asset from one year to the next.

A levelized nominal-dollar stream of numbers is one way to represent the cost of a power plant. It reflects that if the utility actually bought a combustion turbine today, its costs would be locked in for the 30-year life of the plant. However, using a RECC is more appropriate because it enables the analyst to develop a cost stream for a period shorter than the full life of the plant.<sup>254</sup>

The first step in calculating the RECC begins with calculating the year-by-year revenue requirement of a given asset. One must look at the entire time stream of ownership of an asset and calculate a present value of revenue requirements over the life of the asset using utility accounting. The discount rate used in such a calculation is typically the utility rate of return. (However, there are arguments among analysts as to whether that discount rate is reduced for the tax deductibility of bond interest.<sup>255</sup>) The present value of revenue requirements includes return, depreciation, and income and property taxes and may include certain other costs such as property insurance. From this present value of

revenue requirements, one can then calculate the RECC. This is the number of dollars in the first year that, when increased at the rate of inflation every year, results in the same present value at the end of the time period as the present value of revenue requirements.<sup>256</sup>

Figure 47 on the next page is a conceptual example to show the capital and operations and maintenance (O&M) costs for a combustion turbine with a 30-year life. The assumptions used in this example regarding the combustion turbine's capital and O&M costs, as well as capital structure, were developed in a Southwest Public Service Co. case in Texas.<sup>257</sup> The result is that, for this example, the nominal dollar revenue requirement (capital plus O&M) in the first year is \$83.54 per kW-year, declining to about \$33 per kW-year at the end of the plant's 30-year life as the plant is depreciated. The nominal levelized cost is \$63.20. The first-year cost using the RECC is \$53.47.

Costs are somewhat sensitive to financial input assumptions. For example, using the capital structure (51% equity and 49% debt) and return on equity (9.3%) offered by the Office of Public Utility Counsel, the first-year RECC in this case would be \$52.32. Using Southwest Public Service Co.'s capital structure (58% equity and 42% debt) and return on equity (10.25%), the first-year RECC would be \$57.51.

253 This appendix is adapted from Marcus, W. (2018, May). Cross-rebuttal testimony on behalf of the Office of Public Utility Counsel, Appendix A. Public Utility Commission of Texas Docket No. 47527.

254 Costs calculated based upon time periods shorter than 25 years are considered deferred rather than avoided because combustion plant life cycles are 25 years or greater.

255 Marcus, W. (2013, December). Testimony on behalf of The Utility Reform Network, pp. 2-5. California Public Utilities Commission Application No. 13-04-012.

256 This method of calculating the RECC was developed by National Economic Research Associates (now known as NERA Economic Consulting) in the late 1970s.

257 The case is Public Utility Commission of Texas Docket No. 47527. The capital and O&M costs (\$621 per kW and \$7.27 per kW-year, respectively) and the inflation rate (1.74%) are from testimony of J. Pollock on behalf of Texas Industrial Energy Consumers (2018, April 25). Property tax rates (0.67%) are those estimated in testimony of N. Koch on behalf of Southwest Public Service Co., Attachment NK-RR-5 (2017, August 21). In addition, the capital structure (48% debt, 52% equity) and return on equity (9.6%) are from the settlement of Southwest Public Service's previous case in Docket No. 45524, with the cost of debt adjusted to the level from Docket No. 47527 (4.38%).



**Figure 47. Comparison of temporal distributions for combustion turbine cost recovery**

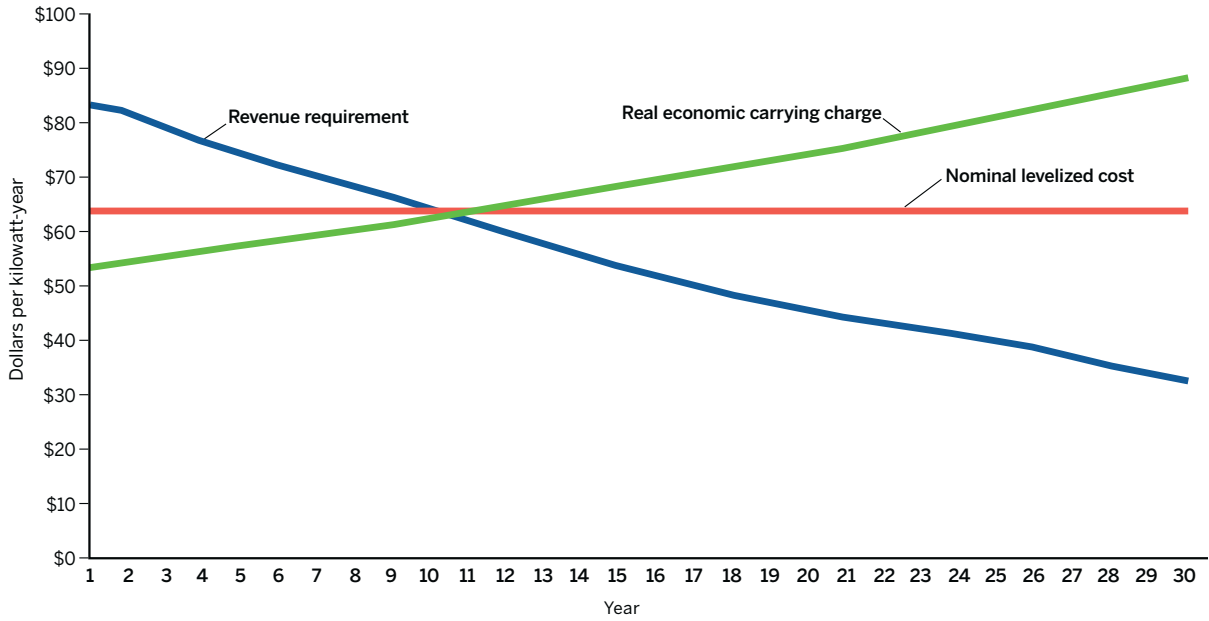

Sources: Based on testimony in Public Utility Commission of Texas Docket No. 47527 and settlement of Docket No. 45524 involving Southwest Public Service Co.

## Appendix C: Inconsistent Calculation of Kilowatts in Marginal Cost Studies

**T**wo examples of problematic inconsistencies in measures of demand are identified here to illustrate the problem. Although we have chosen these particular examples, we recognize that additional inconsistencies are likely to be found when analyzing other cost studies.

Pacific Gas & Electric measures demand (except for new hookups, which are measured based on demand at the transformer) using the hottest year in 10 years to develop the marginal cost per kW of regional distribution demand. It thus develops a lower cost per kW than if it used a normal year. The company then multiplies this cost by a peak capacity allocation factor based on a normal year.<sup>258</sup> The peak capacity allocation factor is lower than even the peak demand of the normal year. As a result of the inconsistent measures of demand, its marginal cost revenue requirement of demand is too low relative to its marginal cost revenue requirement of customer costs, inflating the role of customer costs in

distribution marginal costs.

Southern California Edison has the same problem, only worse. Its marginal costs are calculated based on system capacity, not demand. System capacity is usually much higher than system demand. As an example, Southern California Edison's subtransmission substation capacity is about 37,000 MWs, even though its time-varying system demand is about 16,000 MWs. The result is that the company obtains a low figure in dollars per kW of capacity (developed using a NERA Economic Consulting regression based on 37,000 MWs of capacity). It then multiplies this figure by 16,000 MWs of time-varying demand. As a result, about 57% of real costs of Edison subtransmission investments disappear in the NERA cost allocation methodology. This mismatch benefits large customers, whose total distribution costs have a larger fraction of subtransmission costs than smaller customers.<sup>259</sup>

---

258 California Office of Ratepayer Advocates. (2017, February). Testimony, Chapter 4. California Public Utilities Commission Application No. 16-06-013.

259 Marcus, W. (2018, March 23). Testimony on behalf of The Utility Reform Network, pp. 23-28. California Public Utilities Commission Application No. 17-06-030.

## Appendix D: Transmission and Distribution Replacement Costs as Marginal Costs<sup>260</sup>

A competitive business could not continue to operate in the intermediate term if its prices did not recover its costs of doing business. These include the full amount of its O&M costs, plus a return on new capital expenditures (including both capital additions and replacements to the existing system that are necessary to serve the loads of its existing customer base) and investments required to serve new loads and customers. This definition would exclude all sunken capital costs.

To understand this point, an example from another industry might be helpful. Assume that package delivery growth has stagnated in a given area, such that only the same number of packages must be delivered for each of the next 10 years. Then assume that the delivery company (which serves only this area) must replace a portion of its fleet of delivery trucks in order to keep delivering this stable number of packages at some point during this time frame. The NERA method of marginal cost analysis would assume that the replacement trucks are not a marginal cost of serving the demand for packages in this area. As a result, the NERA method assumes that it would be economically inefficient for the trucking company to recover the cost of those replacement trucks (unless a portion of the costs could be recovered in advance at a time when the package demand in the area was growing, prior to the time when truck replacement was actually required), because it would require charging more than the marginal cost of operating the existing trucks.

Moreover, assume that the real cost of trucks increased dramatically in the period between the time the delivery company purchased its original delivery truck fleet and the time it ultimately needs to make replacements of the original fleet (similar to real increases in, for example, the cost of pole replacement and substation transformers due to higher materials costs). Assume also that the price the trucking

firm is able to charge its customers has not increased in real terms and the number of packages that its existing customers send and have delivered, on average, has not changed. The question for the delivery company is then: Is the marginal cost of replacing its trucks at least equal to the marginal revenue it will retain by continuing its ability to serve its existing customer base? If not, then the company will not make the replacements, and it will choose to exit the delivery business and employ its capital elsewhere. Just because the decision does not include the possibility of new, additional customers does not mean the delivery company would not make its decision to replace its fleet on the basis of marginal cost and revenue.

The difference between the NERA utility system and the trucking company is largely of degree, not kind: Utility replacements are required less frequently than those of the trucking company and can often be deferred for years; wires must serve a fixed route, whereas the route of a delivery truck may change; and the utility is a monopoly, whereas a trucking company may not be. However, the recovery of the cost of replacements is still part of the long-run marginal cost structure of both companies. Neither could stay in business in a competitive market if each does not recover replacement costs in some way.

In essence, the NERA method's view of this issue is based on the assumption that marginal cost applies only to new demand and not to the retention of existing demand. But this view of marginal cost is not economically correct. First, if the utility does not make required replacements, it will no longer be able to supply load. If it cannot supply load, the quantity

---

<sup>260</sup> This discussion is adapted from Jones, G., and Marcus, W. (2015, March 13). Testimony on behalf of The Utility Reform Network, pp. 23-26. California Public Utilities Commission Application No. 14-06-014.

demand from the utility will necessarily decline — utility customers will necessarily have to demand their electrons from other sources, such as exclusive distributed generation and storage. Second, marginal cost principles include small changes in costs for small changes in production (not necessarily increases) as a result of changes in demand. Without replacement, and therefore continued service, the utility would not be able to serve the load demanded by existing customers. Were this to occur, the marginal change would be a decline in demand, but it would still be a change in

demand, which is what the marginal principles with which we are concerned are to measure in the first place. Finally, a business that cannot continue to serve its existing customers under its cost structure cannot stay in business without losing demand from customers that it can no longer serve economically. Replacement costs (with a few exceptions like undergrounding for policy and aesthetic reasons) are required to assure that loads of existing customers do not decline due to a dilapidated and disintegrating system.

## Appendix E: Undervaluation of Long-Run Avoided Generation Costs in the NERA Method

The theoretical framework of the NERA method to justify the marginal costs based on a combustion turbine for capacity plus projected short-run marginal costs (SRMC) for energy is predicated on the assumption that a utility will add a baseload resource only at the time it will lower average generation costs. Using this fact alone, it can be demonstrated mathematically that SRMC, assuming the existence of the new plant (SRMC<sub>1</sub> henceforth), can be below the price that a utility would pay to cost-effectively build a new plant.

The following discussion focuses on the energy cost term. For the cost-effectiveness above to hold, the annual capital cost plus total operating costs of the new plant, less the annual and fixed operating costs of peaking capacity, must be less than the energy costs on the new system avoided by the new plant. Only if these conditions hold would the new plant reduce energy costs.

In the following mathematical demonstration:

- SRMC refers solely to energy costs.
- The cost of a peaker is subtracted from the cost of the new plant.
- SRMC<sub>1</sub> is the SRMC with the new plant included.
- The avoided cost from a new plant (ACNP) is the energy cost on the existing system avoided by the new plant.
- SRMC<sub>2</sub> is the SRMC without the new plant.
- The new plant cost (NPC) is the total capital plus operating cost of the new plant net of peaker capital and fixed operating costs.

The following inequality must hold:

$$\text{SRMC}_1 \leq \text{ACNP} \leq \text{SRMC}_2$$

It essentially states that the SRMC curve declines as resources with low fuel costs are added to a utility system that is otherwise the same. In nonmathematical terms, the

equation embodies the fact that, for example, the SRMC calculated for a utility system with 100 MWs of must-take wind generation added to the system is below that calculated in the base case without the wind generation.

For the average cost to decline when a new plant is added, a second inequality must also hold:

$$\text{NPC} < \text{ACNP}$$

The new plant must be cheaper than the costs avoided on the existing system by the plant.

Since  $\text{SRMC}_1 \leq \text{ACNP}$ , a new utility generating station can be cost-effective if its cost is greater than SRMC<sub>1</sub>, as the following inequality shows:

$$\text{SRMC}_1 < \text{NPC} \leq \text{ACNP}$$

If  $\text{SRMC}_1 > \text{NPC}$ , then the resource is an “inframarginal” resource with costs well below system marginal costs and would be cost-effective at a time of system need for capacity. If the only resources that a utility was building were inframarginal, then SRMC<sub>1</sub> represents avoided cost because the utility plant would be cheaper.

If utility plant were infinitely divisible and the utility system were in equilibrium, the special case of a fourth equation would be true:

$$\text{SRMC}_1 = \text{ACNP} = \text{NPC}$$

In other words, short-run and long-run avoided cost would be equal.

However, if  $\text{SRMC}_1 < \text{NPC}$ , then the utility’s short-run marginal costs under the NERA method are less than long-run avoided costs. Use of SRMC<sub>1</sub> for resource plan evaluation and rate design thus would skew results away from options that may be cheaper than the new plant and would result in allocation and rate design decisions that undervalue energy relative to other components of marginal cost.

# Glossary

**Adjustment clause**

A rate adjustment mechanism implemented on a recurring and ongoing basis to recover changes in expenses or capital expenditures that occur between rate cases. The most common adjustment clause tracks changes in fuel costs and costs of purchased power. Some utilities have weather normalization adjustment clauses that correct for abnormal weather conditions. See also **tracker** and **rider/tariff rider**.

**Administrative and general costs** *Abbreviation: A&G*

Capital investments and ongoing expenses that support all of a utility's functions. One example of such a capital investment is an office building that houses employees for the entire utility. An example of such an ongoing expense is the salaries of executives who oversee all parts of the utility.

**Advanced metering infrastructure** *Abbreviation: AMI*

The combination of smart meters, communication systems, system control and data acquisition systems, and meter data management systems that together allow for metering of customer energy usage with high temporal granularity; the communication of that information to the utility and, optionally, to the customer; and the potential for direct end-use control in response to real-time cost variations and system reliability conditions. AMI is an integral part of the smart grid concept.

**Allocation/cost allocation**

The assignment of utility costs to customers, customer groups or unbundled services based on cost causation principles.

**Allocation factor/allocator**

A computed percentage for each customer class of the share of a particular cost or group of costs each class is assigned in a cost of service study. Allocation factors are based on data that may include customer count, energy consumption, peak or off-peak capacity, revenue and other metrics.

**Alternating current** *Abbreviation: AC*

Current that reverses its flow periodically. Electric utilities generate and distribute AC electricity to residential and business consumers.

**Ampere**

The standard unit of electrical current, formally defined as a quantity of electricity per second. This unit is often used to describe the size of the service connection and service panel for an electricity customer.

**Ancillary service**

One of a set of services offered and demanded by system operators, utilities and, in some cases, customers, generally addressing system reliability and operational requirements. Ancillary services include such items as voltage control and support, reactive power, harmonic control, frequency control, spinning reserves and standby power. The Federal Energy Regulatory Commission defines ancillary services as those services "necessary to support the transmission of electric power from seller to purchaser given the obligations of control areas and transmitting utilities within those control areas to maintain reliable operations of the interconnected transmission system."

**Automated meter reading** *Abbreviation: AMR*

Automated meter reading systems use radio or other means to download data from meters periodically without a need for a meter reader to visit each location. They typically do not include interval data of sufficient precision to support advanced services such as critical peak pricing. More sophisticated systems are usually called advanced metering infrastructure.

**Average-and-peak method**

A method of apportioning demand-related generation, transmission or distribution costs that assigns a portion of costs equal to the system load factor to all classes based on the kWh usage (average demand) of the class and the balance of costs to each class based on peak demand of each class. The metric for peak demand can be any of those described under **peak responsibility method**.

**Avoided cost**

The cost not incurred by not providing an incremental unit of service. Short-run avoided cost is the incremental variable cost to produce another unit from existing facilities. Long-run avoided cost includes the cost of the next power plant a utility would have to build to meet growing demand, plus the costs of augmenting reliability reserves, additional transmission and distribution facilities, environmental costs and line losses associated with delivering that power.

**Base-intermediate-peak method** *Abbreviation: BIP*

The base-intermediate-peak cost allocation method assigns each component of generation and often transmission and distribution plant to a category of whether it is fully required in all hours (base) or required only in intermediate or peak hours. It then allocates those costs based on the usage of customer classes in each time period.

**Baseload generation/baseload units/baseload capacity/baseload resources**

Electricity generating units that are most economically run for extended hours. Typical baseload units include coal-fired and nuclear-fueled steam generators.

**Basic customer method**

A distribution cost allocation approach that classifies only customer-specific costs — such as meters, billing and collection — as customer-related costs, with all other distribution and operating costs assigned based on demand or energy measures of usage.

**Behind the meter**

Installations of electrical equipment at customer premises, connected to the building or facility wiring at a point where any impacts are measured by the flow through the customer meter. This may include solar photovoltaic or other generating resources, batteries or other storage, or load control equipment. Behind-the-meter installations are usually owned by the retail customer but may be called upon to provide grid services.

**British thermal unit** *Abbreviation: Btu*

A unit of heat, defined as the amount necessary to raise the temperature of 1 pound of water by 1 degree Fahrenheit. Multiples of this unit are frequently used to describe the energy content of fuels.

**Capacity**

The ability to generate, transport, process or utilize power. Capacity is measured in watts, usually expressed as kilowatts (1,000 watts), megawatts (1,000 kilowatts) or gigawatts (1,000 megawatts). Generators have rated capacities that describe the output of the generator when operated at its maximum output at a standard ambient air temperature and altitude.

**Capacity factor**

The ratio of total energy produced by a generator for a specified period to the maximum it could have produced if it had run at full capacity through the entire period, expressed as a percentage. Fossil-fueled generating units with high capacity factors are generally considered baseload power plants, and those with low capacity factors are generally considered peaking units. These labels do not apply to wind or solar units because the capacity factors for these technologies are driven by weather conditions and not decisions around optimal dispatch.

**Capacity-related costs**

See **demand-related costs**.

**Circuit**

This generally refers to a wire that conducts electricity from one point to another. At the distribution level, multiple customers may be served by a single circuit that runs from a local substation or transformer to those customers. At the transmission level, the term “circuit” may also describe a pathway along which energy is transported or the number of wires strung along that pathway. See also **conductor**.

**Classification**

A step in some cost allocation methods in which costs are defined into categories such as energy-related, demand-related and customer-related.

**Coincident peak** *Abbreviation: CP*

The combined demand of a single customer or multiple customers at a specific point in time or circumstance, relative to the peak demand of the system, in which “system” can refer to the aggregate load of a single utility or of multiple utilities in a geographic zone or interconnection or some part thereof.

**Combined cycle unit**

A type of generation facility based on combustion that combines a combustion turbine with equipment to capture waste heat to generate additional electricity. This results in more efficient operation (higher output per unit of fuel input).

**Combustion turbine**

A power plant that generates electricity by burning oil or natural gas in a jet engine, which spins a shaft to power a generator. Combustion turbines are typically relatively low efficiency, have lower capital costs than other forms of generation and are used primarily as peaking power plants.

**Community choice aggregation**

Community choice aggregation involves a municipality or other local entity serving as the electricity purchasing central agent for all customers within a geographic area. The distribution system is still operated by a regulated utility. In some cases, customers can opt out and use another method to obtain electricity supply.

**Competitive proxy method**

The usage of information on energy and capacity revenue in competitive wholesale markets in order to classify generation assets for vertically integrated utilities between energy-related and demand-related.

**Conductor**

The individual wire or line that carries electricity from one point to another.

**Connection charge**

An amount to be paid by a customer to the utility, in a lump sum or installments, for connecting the customer’s facilities to the supplier’s facilities.

**Contribution in aid of construction**

Utilities sometimes require customers to pay a portion of the cost of extending distribution service into sparsely populated areas. These contributions are recorded as a contribution in aid of construction or sometimes as a customer advance that is refundable if additional customers in that area opt for electricity service.

**Cooperative** *Abbreviation: co-op*

A not-for-profit utility owned by the customer-members. A co-op is controlled by a member-elected board that includes representatives from business customers.

**Cost allocation**

Division of a utility’s revenue requirement among its customer classes. Cost allocation is an integral part of a utility’s cost of service study.

**Cost of service**

Regulators use a cost of service approach to determine a fair price for electric service, by which the aggregate costs for providing each class of service (residential, commercial and industrial) are determined. Prices are set to recover those costs, plus a reasonable return on the invested capital portion of those costs.



**Cost of service study**

An analysis performed in the context of a rate case that allocates a utility's allowed costs to provide service among its various customer classes. The total cost allocated to a given class represents the costs that class would pay to produce an equal rate of return to other classes. Regulators frequently exercise judgment to adopt rates that vary from study results.

**Critical peak**

A limited number of hours every year when the electric system, or a portion of it, is under a significant amount of stress that could cause reliability problems or the need for nontrivial capital investments.

**Critical peak pricing**

A form of dynamic retail rate design where a utility applies a substantially higher rate, with advance notice to customers, for a limited number of hours every year when the electric system is projected to be under a significant amount of stress.

**Curtailement**

This can refer to different sets of practices for either load or variable renewable generation. With respect to load, curtailment represents a reduction in usage in response to prices and programs or when system reliability is threatened. Price-responsive load curtailment is also known as demand response. Utilities and independent system operators typically have curtailment plans that can be used if system reliability is threatened. Curtailment of variable renewable generation can take place if there is an economic or system reliability reason why the electric system cannot take incremental energy from these units. This could occur when there is more energy available than can be transmitted given delivery constraints, or if the operating constraints of other generators are such that it is more efficient to curtail renewable generation rather than ramp down other units.

**Customer charge**

A fixed charge to consumers each billing period, typically to cover metering, meter reading and billing costs that do not vary with size or usage. Also known as a basic service charge or standing charge.

**Customer class**

A collection of customers sharing common usage or interconnection characteristics. Customer classes may include residential (sometimes called household), small commercial, large commercial, small industrial, large industrial, agriculture (primarily irrigation pumping), mining and municipal lighting (streetlights and traffic signals). All customers within a class are typically charged the same rates, although some classes may be broken down into subclasses based on the nature of their loads, the capacity of their interconnection (e.g., the size of commercial or residential service panel) or the voltage at which they receive service.

**Customer noncoincident peak demand (or load)**

The highest rate of usage in a measurement period of an individual customer — typically in a one-hour, 30-minute or 15-minute interval — unaffected by the usage of other customers sharing the same section of a distribution grid. Also known as maximum customer demand. See also **noncoincident peak**.

**Customer-related costs**

Costs that vary directly with the number of customers served by the utility, such as metering and billing expenses.

**Decomposition method**

A legacy method that jointly classifies and allocates generation assets. This method assumes that customer classes with high load factors are served by high-capacity-factor baseload resources. In many cases, such a method would advantage the large industrial customer class, although that does depend on the cost of the baseload resources in question. Among other issues, this method ignores reserve requirements or other backup supply needs and any need to equitably share the costs of excess capacity.

### **Decoupling**

Decoupling fixes the amount of revenue to be collected and allows the price charged to float up or down between rate cases to compensate for variations in sales volume in order to maintain the set revenue level. The target revenue is sometimes allowed to increase between rate cases on the basis of an annual review of costs or a fixed inflator, or on the basis of the number of customers served. The latter approach is sometimes known as revenue-per-customer decoupling. The purpose is to allow utilities to recover allowed costs, independent of sales volumes, without under- or overcollection over time. Also known as revenue regulation.

### **Default service/default supply**

In a restructured electric utility, the power supply price a customer will pay if a different supplier than the distribution utility is not affirmatively chosen. Most residential and small-business consumers are served by the default supply option in areas where it is available. Also known as standard service offer or basic service.

### **Demand**

In theory, an instantaneous measurement of the rate at which electricity is being consumed by a single customer or customer class or the entirety of an electric system, expressed in kilowatts or megawatts. Demand is the load-side counterpart to an electric system's capacity. In practical terms, electricity demand is actually measured as the average rate of energy consumption over a short period, usually 15 minutes or an hour. For example, a 1,000-watt hair dryer run for the entirety of a 15-minute demand interval would cause a demand meter using a 15-minute demand interval to record 1 kilowatt of demand. If that same hair dryer were run for only 7.5 minutes, however, the metered demand would be only 0.5 kilowatt. Not all electric meters measure demand.

### **Demand charge**

A charge paid on the basis of metered demand typically for the highest hour or 15-minute interval during a billing period. Demand charges are usually expressed in dollars per watt units, such as kilowatts. Demand charges are common

for large (and sometimes small) commercial and industrial customers but have not typically been used for residential customers because of the very high diversity among individual customers' usage and the higher cost of demand meters or interval meters. The widespread deployment of smart meters would enable the use of demand charges or time-of-use rates for any customer served by those meters.

### **Demand meter**

A meter capable of measuring and recording a customer's demand. Demand meters include interval meters and smart meters.

### **Demand-related costs/capacity-related costs**

Costs that vary directly with the system capacity to meet peak demands. This can be measured separately for the generation, transmission and distribution segments of the utility system.

### **Demand response**

Reduction in energy use in response to either system reliability concerns or increased prices (where wholesale markets are involved) or generation costs (in the case of vertically integrated utilities). Demand response generally must be measurable and controllable to participate in wholesale markets or be relied upon by system operators.

### **Depreciation**

The loss of value of assets, such as buildings and transmission lines, owing to age and wear.

### **Direct current** *Abbreviation: DC*

An electric current that flows in one direction, with a magnitude that does not vary or that varies only slightly.

### **Distributed energy resource** *Abbreviation: DER*

Any resource or activity at or near customer loads that generates energy, reduces consumption or otherwise manages energy on-site. Distributed energy resources include customer-site generation, such as solar photovoltaic systems and emergency backup generators, as well as energy efficiency, controllable loads and energy storage.

**Distributed generation**

Any electricity generator located at or near customer loads. Distributed generation usually refers to customer-sited generation, such as solar photovoltaic systems, but may include utility-owned generation or independent power producers interconnected to the distribution system.

**Distribution**

The delivery of electricity to end users via low-voltage electric power lines (usually 34 kV and lower).

**Distribution utility**

A utility that owns and operates only the distribution system. It may provide bundled service to customers by purchasing all needed energy from one or more other suppliers or may require that customers make separate arrangements for energy supply. See also **vertically integrated utility**.

**Distribution system**

That portion of the electric system used to distribute energy to customers. The distribution system is usually distinguished from the transmission system on the basis of voltage and function. Components operating above 100 kV are considered transmission. Components operating below 50 kV are considered distribution. Facilities between 50 kV and 100 kV are often termed subtransmission but are normally included in the distribution service FERC accounts. After energy is received from a large generating facility, its voltage is stepped up to very high levels where it is transported by the transmission system. Power from distributed generating facilities such as small photovoltaic systems is normally delivered into the distribution system and transported to nearby customers at the distribution system level without ever entering the transmission system.

**Distribution system operator**

The entity that operates the distribution portion of an electric system. In the case of a vertically integrated utility, this entity would also provide generation and transmission services. In many restructured markets, the distribution system operator provides only delivery services and may provide only limited energy services as a provider of last resort.

**Diversity/customer diversity/load diversity**

The measurement of how different customers use power at different times of the day or year, and the extent to which those differences can enable sharing of system generation, transmission or distribution capacity. For example, schools use power primarily during the day, and street lighting uses power exclusively during hours of darkness; they are able to share system capacity. By contrast, continuous-use customers, such as data centers and all-night mini-marts, preempt the use of capacity. Irrigators use power in summer, and space heat uses power in winter, also allowing the seasonal sharing of generation but sometimes not of distribution capacity.

**Dynamic pricing**

Rates that may be adjusted frequently, such as hourly or every 15 minutes, based on wholesale electricity costs or actual generation costs. Also known as real-time pricing. See also **critical peak pricing**.

**Embedded cost of service study**

A cost allocation study that apportions the actual historic test year or projected future rate year system costs among customer classes, typically using customer usage patterns in a single yearlong period to divide up the costs. Sometimes called a fully allocated cost of service study. See also **marginal cost of service study** and **total service long-run incremental cost**.

**Embedded costs**

The actual current costs, including a return on existing plant, used to provide service. These are reflected in the FERC system of accounts reported in each utility's FERC Form 1 filing. See also **marginal costs**.

**Energy**

A unit of power consumed over a period of time. Energy is expressed in watt-time units, in which the time units are usually one hour, such as a kilowatt-hour, megawatt-hour and so on. An appliance placing 1 kilowatt of demand on the system for an hour will consume 1 kilowatt-hour of energy. See also **watt** and **watt-hour**.

**Energy charge**

A price component based on energy consumed. Energy charges are typically expressed in cents per kilowatt-hour and may vary based on the time of consumption.

**Energy efficiency**

The deployment of end-use appliances that achieve the same or greater end-use value while reducing the energy required to achieve that result. Higher-efficiency boilers and air conditioners, increased building insulation, more efficient lighting and higher energy-rated windows are all examples of energy efficiency. Energy efficiency implies a semipermanent, longer-term reduction in the use of energy by the customer, contrasted with behavioral programs that may influence short-term usage habits. Because energy efficiency reduces the need for generation, transmission and distribution, these costs are properly allocated using the methods applied to all three functions.

**Energy-related costs**

Costs that vary directly with the number of kilowatt-hours the utility provides over a period of time.

**Equal percentage of marginal cost** *Abbreviation: EPMC*

A method of adjusting the results of a marginal cost of service study to the system revenue requirement by adjusting the cost responsibility of each class by a uniform percentage. Often applied within the functional categories of generation, transmission and distribution.

**Equivalent forced outage rate**

The percentage of the hypothetical maximum output of a generating unit during a year that is unavailable due to unplanned outages, either full or partial, of the unit.

**Equivalent peaker method**

A method of classifying production and transmission costs that assigns a portion of investment and maintenance costs as demand-related — based on the cost of a peaking resource such as demand response or a peaking power unit that can be deployed within the service territory — and the balance of

costs as energy-related. Commonly used for nuclear, coal and hydroelectric resources and associated transmission. Also known as the peak credit method.

**Externalities**

Costs or benefits that are side effects of economic activities and are not reflected in the booked costs of the utility. Environmental impacts are the principal externalities caused by utilities (e.g., climate impacts or health care costs from air pollution).

**Extra-high voltage** *Abbreviation: EHV*

Transmission lines operating at 765 kV (alternating current) or roughly 400 kV (direct current) or above.

**Federal Energy Regulatory Commission**

*Acronym: FERC*

The U.S. agency that has jurisdiction over interstate transmission systems and wholesale sales of electricity.

**Fixed charge**

Any fee or charge that does not vary with consumption. Customer charges are a typical form of fixed charge. In some jurisdictions, customers are charged a connected load charge that is based on the size of their service panel or total expected maximum load. Minimum bills and straight fixed/variable rates are additional forms of fixed charges.

**Fixed cost**

This accounting term is meant to denote costs that do not vary within a certain period of time, usually one year, primarily interest expense and depreciation expense. This term is often misapplied to denote costs associated with plant and equipment (which are themselves denoted as fixed assets in accounting terms) or other utility costs that cannot be changed in the short term. From a regulatory and economics perspective, the concept of fixed costs is irrelevant. For purposes of regulation, all utility costs are variable in the long run. Even the costs associated with seemingly fixed assets, such as the distribution system, are not fixed, even in the short run. Utilities are constantly upgrading and replacing distribution

facilities throughout their systems as more customers are served and customer usage increases, and efforts to reduce demand can have immediate impacts on those costs.

#### **Flat volumetric rate**

A rate design with a uniform price per kilowatt-hour for all levels of consumption.

#### **Fuel adjustment clause**

An adjustment mechanism that allows utilities to recover all or part of the variation in the cost of fuel or purchased power from the levels assumed in a general rate case. See also **adjustment clause**.

#### **Fuel cost**

The cost of fuel, typically burned, used to create electricity. Types include nuclear, coal, natural gas, diesel, biomass, bagasse, wood and fuel oil. Some generators, such as wind turbines and solar photovoltaic and solar thermal generators, use no fuel or, in the case of hydroelectric generation, virtually cost-free fuel.

#### **Functionalization**

A step in most cost allocation methods in which costs are defined into functional categories, such as generation-related, transmission-related, distribution-related, or administrative and general costs.

#### **General service**

A term broadly applied to nonresidential customers. It sometimes includes industrial customers and sometimes is distinct from an industrial class. It is often divided into small, medium and large by maximum demand or into secondary and primary by voltage.

#### **Generation**

Any equipment or device that supplies energy to the electric system. Generation is often classified by fuel source (i.e., nuclear, coal, gas, solar and so on) or by operational or economic characteristics (e.g., “must-run,” baseload, intermediate, peaking, intermittent, load following).

#### **Grid**

The electric system as a whole or the nongeneration portion of the electric system.

#### **Heat rate**

The number of British thermal units that a thermal power plant requires in fuel to produce 1 kilowatt-hour.

#### **Highest 100 (or 200) hours method**

A method for allocating demand-related or capacity-related costs that considers class demand over the highest 100 (or 200) hours of usage during the year.

#### **High-voltage direct current** *Abbreviation: HVDC*

An HVDC electric power transmission system uses direct current for the bulk transmission of electrical power, in contrast to the more common alternating current systems. For long-distance transmission, HVDC systems may be less expensive and suffer lower electrical losses.

#### **Hourly allocation**

An allocation approach in which costs or groups of costs are assigned to hourly time periods rather than classified between demand- and energy-related costs.

#### **Incremental cost**

The short-run cost of augmenting an existing system. An incremental cost study rests on the theory that prices should reflect the cost of producing the next unit of energy or deployment of the next unit of capacity in the form of generation, transmission or distribution. See also **long-run marginal costs**, **short-run marginal costs** and **total system long-run incremental cost**.

#### **Independent power producer**

A power plant that is owned by an entity other than an electric utility. May also be referred to as a non-utility generator.

**Independent system operator** *Abbreviation: ISO*

A non-utility entity that has multi-utility or regional responsibility for ensuring an orderly wholesale power market, the management of transmission lines and the dispatch of power resources to meet utility and non-utility needs. All existing ISOs also act as regional transmission organizations, which control and operate the transmission system independently of the local utilities that serve customers. This usually includes control of the dispatch of generating units and calls on demand response resources over the course of a day or year. In regions without an ISO, less formal entities and markets exist for wholesale trading and regional transmission planning. See also **regional transmission organization**.

**Intermediate unit**

A generic term for units that operate a substantial portion of the year but not at all times or just hours near peaks or with reliability issues. As a result, these units can be described as neither baseload nor peaking. Over the past two decades, this role has been filled by natural gas combined cycle units in many places. Intermediate units are also known as midmerit or cycling units.

**Intermittent resources**

See **variable resources**.

**Interruptible rate/interruptible customer**

An interruptible rate is a retail service tariff in which, in exchange for a fee or a discounted retail rate, the customer agrees to curtail service when called upon to do so by the entity offering the tariff, which may be the local utility or a third-party curtailment service provider. A customer's service may be interrupted for economic or reliability purposes, depending on the terms of the tariff. Customers on these rates are sometimes described as interruptible customers, and it is said that they receive interruptible service.

**Interval meter**

A meter capable of measuring and recording a customer's detailed consumption data. An interval meter measures demand by recording the energy used over a specified interval of time, usually 15 minutes or an hour.

**Inverse elasticity rule**

A method of reconciling the marginal cost revenue requirement with the embedded cost revenue requirement. In principle, the adjustment of the least-elastic element of costs (and thus the underlying rates) produces a less distortive and more optimal outcome for customer behavior. The inverse elasticity rule follows this principle by adjusting the least-elastic element upward if there is a shortfall or downward if there is a surplus. There are numerous theoretical and practical difficulties in determining which element of costs or rates is least elastic.

**Investor-owned utility** *Abbreviation: IOU*

A utility owned by shareholders or other for-profit owners. A majority of U.S. electricity consumers are served by IOUs.

**Kilovolt** *Abbreviation: kV*

A kilovolt is equal to 1,000 volts. This unit is the typical measure of electric potential used to label transmission and primary distribution lines.

**Kilovolt-ampere** *Abbreviation: kVA*

A kilovolt-ampere is equal to 1,000 volt-amperes. This unit is the typical measure for the capacity of line transformers.

**Kilowatt** *Abbreviation: kW*

A kilowatt is equal to 1,000 watts.

**Kilowatt-hour** *Abbreviation: kWh*

A kilowatt-hour is equal to 1,000 watt-hours.

**Line transformer**

A transformer directly providing service to a customer, either on a dedicated basis or among a small number of customers. A line transformer typically is stepping down power on a distribution line from primary voltage to secondary voltage that consumers can use directly.

**Load**

The combined demand for electricity placed on the system. The term is sometimes used in a generalized sense to simply denote the aggregate of customer energy usage on the system,

or in a more specific sense to denote the customer demand at a specific point in time.

#### **Load factor**

The ratio of average load of a customer, customer class or system to peak load during a specific period of time, expressed as a percentage.

#### **Load following**

The process of matching variations in load over time by increasing or decreasing generation supply or, conversely, decreasing or increasing loads. One or more generating units or demand response resources will be designated as the load following resources at any given time. Baseload and intermediate generation is generally excluded from this category except in extraordinary circumstances.

#### **Load shape**

The distribution of usage across the day and year, reflecting the amount of power used in low-cost periods versus high-cost periods.

#### **Long-run marginal costs/long-run incremental costs**

The costs of expanding or maintaining the level of utility service, including the cost of a new or replacement power plants, transmission and distribution, reserves, marginal losses, and administrative and environmental costs, measured over a period of years in which new investment is expected to be needed.

#### **Losses/energy losses/line losses**

The energy (kilowatt-hours) and power (kilowatts) lost or unaccounted for in the operation of an electric system. Losses are usually in the form of energy lost to heat, sometimes referred to as technical losses; energy theft from illegal connections or tampered meters is sometimes referred to as nontechnical losses.

#### **Loss-of-energy expectation**

A mathematical study of a utility system, applying expected availability of multiple generating resources, that estimates the expected energy loss at each hour of the year when power supply and demand response resources are insufficient to meet customer demand. Related terms: loss-of-load probability, loss-of-load hours, loss-of-load expectation, probability of peak and expected unserved energy.

#### **Loss-of-energy expectation method**

A method for allocating demand-related costs in a manner that is weighted over all of the hours with reliability risks.

#### **Marginal cost of service study**

A cost allocation study that apportions costs among customer classes using estimates of how costs change over time in response to changes in customer usage. See also **embedded cost of service study** and **total service long-run incremental cost**.

#### **Marginal costs**

The cost of augmenting output. Short-run marginal costs are the incremental expenses associated with increasing output with existing facilities. Long-run marginal costs are the incremental capital and operating expenses associated with increasing output over time with an optimal mix of assets. Total system long-run incremental costs are the costs of building a new system in its entirety, a measure used to determine if an existing utility system is economical.

#### **Marginal cost revenue requirement** *Abbreviation:*

##### **MCRR**

An output in a marginal cost of service study, where the marginal unit costs for each element of the electric system are multiplied by the billing determinants for each class to produce a class marginal cost revenue requirement for each element. These can be aggregated to produce a system MCRR. It is only happenstance if the system MCRR equals the embedded cost revenue requirement, so the elements of the MCRR can be used in different ways to allocate embedded costs among the customer classes. See also **reconciliation**.

**Megawatt** *Abbreviation: MW*

A megawatt is equal to 1 million watts or 1,000 kilowatts.

**Megawatt-hour** *Abbreviation: MWh*

A megawatt-hour is equal to 1 million watt-hours or 1,000 kilowatt-hours.

**Megawatt-year**

A megawatt-year is the amount of energy that would equal 1 megawatt continuously for one year, or 8.76 million kilowatt-hours. Also known as an average megawatt.

**Meter data management system**

A computer and control system that gathers metering information from smart meters and makes it available to the utility and, optionally, to the customer. A meter data management system is part of the suite of smart technologies and is integral to the smart grid concept.

**Midpeak**

Hours that are between on-peak hours and off-peak hours. These are typically the hours when intermediate power plants are operating but peaking units are not. Used primarily in the base-intermediate-peak cost allocation method and in time-of-use rate design.

**Minimum system method**

A method for classifying distribution system costs between customer-related and demand- or energy-related. It estimates the cost of building a hypothetical system using the minimum size components available as the customer-related costs and the balance of costs as demand-related or energy-related.

**Municipal utility** *Abbreviation: muni*

A utility owned by a unit of government and operated under the control of a publicly elected body.

**National Association of Regulatory Utility Commissioners** *Acronym: NARUC*

The association of state and federal regulatory agencies that determine electric utility tariffs and service standards. It

includes the state, territorial and federal commissions that regulate utilities and some transportation services.

**NERA method**

An approach to measuring marginal costs for electric utilities that considers a mix of time frames. It looks at customer-related costs such as metering on a full replacement or new install basis and at transmission or distribution capacity costs over a time frame of 10 years or more to include at least some capacity upgrades. Generation costs consider the new install costs for peaking capacity and a dispatch model approach to variable energy costs. The NERA method has formed the foundation for the methods used in several states today, but each state has modified the approach. This approach is named after the firm that developed it in the 1970s, National Economic Research Associates (now NERA Economic Consulting).

**New-customer-only method** *Abbreviation: NCO*

A short-run method for estimation of marginal customer connection costs based on the cost of hookups for new customers. This method may or may not include the percentage of existing hookups that are replaced every year. See also **rental method**.

**Noncoincident peak** *Abbreviation: NCP*

The maximum demand of a customer, group of customers, customer class, distribution circuit or other portion of a utility system, independent of when the maximum demand for the entire system occurs.

**Off-peak**

The period of time that is not on-peak. During off-peak periods, system costs are generally lower and system reliability is not an issue, and only generating units with lower short-run variable costs are operating. This may include high-load hours if nondispatchable generation, such as solar photovoltaic energy, is significant within the service area. Time-of-use rates typically have off-peak prices that are lower than on-peak prices.



**On-peak**

The period of time when storage units and generating units with higher short-run variable costs are operating to supply energy or when transmission or distribution system congestion is present. During on-peak periods, system costs are higher than average and reliability issues may be present. Many rate designs and utility programs are oriented to reducing on-peak usage. Planning and investment decisions are often driven by expectations about the timing and magnitude of peak demand during the on-peak period. Time-of-use rates typically have on-peak prices that are higher than off-peak prices.

**Operational characteristics method**

The traditional version of this method uses the capacity factor of a resource to determine the energy-related percentage of the costs of a generation asset and designates the remainder as demand-related. Although this provides a reasonable result in some circumstances, it inaccurately increases the demand-related percentage for less-reliable resources. A variation on this approach is to use the operating factor — the ratio of output to the equivalent availability of the unit — as the energy-related percentage.

**Operations and maintenance costs** *Abbreviation: O&M*

All costs associated with operating, maintaining and supporting the utility plant, including labor, outside services, administrative costs and supplies. For generation facilities, this includes O&M expenses that vary directly with the output of the facility (dispatch O&M), such as fuel and water treatment, and expenses that do not vary with output but are incurred yearly or monthly (nondispatch O&M).

**Peak capacity allocation factor** *Acronym: PCAF*

An allocation factor where a weighted portion of demand-related costs is assigned to every hour in excess of 80% of peak demand. This method, used in California, is weighted such that the peak hour has an allocation that is 20 times the allocation for the hours at 81% of peak demand and twice the allocation of an hour at 90% of peak demand.

**Peak demand**

The maximum demand by a single customer, a group of customers located on a particular portion of the electric system, all of the customers in a class or all of a utility's customers during a specific period of time — hour, day, month, season or year.

**Peaking resources/peaking generation/peakers**

Generation that is used to serve load during periods of high demand. Peaking generation typically has high fuel costs or limited availability (e.g., storage of hydrogeneration) and often has low capital costs. Peaking generation is used for a limited number of hours, especially as compared with baseload generation. Peaking resources often include nongeneration resources, such as storage or demand response.

**Peak load**

The maximum total demand on a utility system during a period of time.

**Peak responsibility method**

A method of apportioning demand-related generation or transmission costs based on the customer class share of maximum demand on the system. The metric can be a single hour (1 CP), the highest hour in several months (such as 4 CP), the highest hour in every month (12 CP) or the entire group of highest peak hours (such as 200 CP). See also **coincident peak**.

**Performance-based regulation** *Abbreviation: PBR*

An approach to determining the utility revenue requirement that departs from the classical formula of rate base, rate of return, and operation and maintenance expense. It is designed to encourage improved performance by utilities on cost control or other regulatory goals.

**Postage stamp pricing**

The practice of having separate sets of prices for a relatively small and easily identifiable number of customer classes. Every customer in a given customer class generally pays the same prices regardless of location in a utility's service territory, although separate prices may exist for subclasses in some cases.

**Power factor**

The fraction of power actually used by a customer's electrical equipment compared with the total apparent power supplied, usually expressed as a percentage. A power factor indicates the extent to which a customer's electrical equipment causes the electric current delivered at the customer's site to be out of phase with system voltage.

**Power quality**

The power industry has established nominal target operating criteria for a variety of properties associated with the power flowing over the electric grid. These include frequency, voltage, power factor and harmonics. Power quality describes the degree to which the system, at any given point, is able to exhibit the target operating criteria.

**Primary voltage/primary service**

Primary voltage normally includes voltages between 2 kV and 34 kV. Primary voltage facilities generally are considered part of the distribution system.

**Probability-of-dispatch method** *Abbreviation: POD*

A cost allocation methodology that considers the likelihood that specific generating units and transmission lines will be needed to provide service at specific periods during the year and assigns costs to each period based on those probabilities.

**Public utilities commission/public service commission**

The state regulatory body that determines rates for regulated utilities. Although they go by various titles, these two are the most common.

**Public Utilities Regulatory Policy Act**

*Acronym: PURPA*

This federal law, enacted in 1978 and amended several times, contains two essential elements. The first requires state regulators to consider and determine whether specific rate-making policies should be adopted, including whether rates should be based on the cost of service. The second requires utilities to purchase power at avoided-cost prices from independent power producers.

**Rate base**

The net investment of a utility in property that is used to serve the public. This includes the original cost net of depreciation, adjusted by working capital, deferred taxes and various regulatory assets. The term is often misused to describe the utility revenue requirement.

**Rate case**

A proceeding, usually before a regulatory commission, involving the rates, revenues and policies of a public utility.

**Rate design**

Specification of prices for each component of a rate schedule for each class of customers, which are calculated to produce the revenue requirement allocated to the class. In simple terms, prices are equal to revenues divided by billing units, based on historical or assumed usage levels. Total costs are allocated across the different price components such as customer charges, energy charges and demand charges, and each price component is then set at the level required to generate sufficient revenues to cover those costs.

**Rate of return**

The weighted average cost of utility capital, including the cost of debt and equity, used as one of the three core elements of determining the utility revenue requirement and cost of service, along with rate base and operating expense.

**Rate year**

The period for which rates are calculated in a utility rate case, usually the 12-month period immediately following the expected effective date of new rates at the end of the proceeding.

**Real economic carrying charge** *Acronym: RECC*

An annualized cost expressed in percentage terms that reflects the annual "mortgage" payment that would be required to pay off a capital investment at the utility's real (net of inflation) cost of capital over its expected lifetime. It is used in long-run marginal cost and total system long-run incremental cost studies.

### **Reconciliation/revenue reconciliation/ cost reconciliation**

In a marginal cost of service study, it is only happenstance if the system marginal cost revenue requirement is equal to the embedded cost revenue requirement that needs to be recovered by the utility to earn a fair return. As a result, the marginal cost revenue requirement must be reconciled to the embedded cost revenue requirement. There are two primary methods for this: equal percentage of marginal cost and the inverse elasticity rule. See also **marginal cost revenue requirement**.

### **Regional Greenhouse Gas Initiative**

An agreement among Northeast and mid-Atlantic states to limit the amount of greenhouse gases emitted in the electric power sector and to price emissions by auctioning emissions allowances.

### **Regional transmission organization** *Abbreviation: RTO*

An independent regional transmission operator and service provider established by FERC or that meets FERC's RTO criteria, including those related to independence and market size. RTOs control and manage the high-voltage flow of electricity over an area generally larger than the typical power company's service territory. Most also serve as independent system operators, operating day-ahead, real-time, ancillary services and capacity markets, and conduct system planning. See also **independent system operator**.

### **Renewable portfolio standard** *Abbreviation: RPS*

A requirement established by a state legislature or regulator that each electric utility subject to its jurisdiction obtain a specified portion of its electricity from a specified set of resources, usually renewable energy resources but sometimes including energy efficiency, nuclear energy or other categories.

### **Rental method**

A method of estimating marginal customer connection costs where the cost of new customer connection equipment is multiplied by the real economic carrying charge to obtain

an estimate of a rental price. This is a long-run method for customer connection costs that has been a part of the NERA method for marginal costs. See also **new-customer-only method**.

### **Reserves/reserve capacity/reserve margin**

The amount of capacity that a system must be able to supply, beyond what is required to meet demand, to assure reliability when one or more generating units or transmission lines are out of service. Traditionally a 15% to 20% reserve capacity was thought to be needed for good reliability. In recent years, due to improved system controls and data acquisition, the accepted value in some areas has declined to 10% or lower.

### **Restructured state/restructured utility/ restructured market**

Replacement of the traditional vertically integrated utility with some form of competitive market. In some cases, the generation and transmission components of service are purchased by the customer-serving distribution utility in a wholesale competitive market. In other cases, retail customers are allowed to choose their generation suppliers directly in a competitive market.

### **Retail competition/retail choice**

A restructured market in which customers are allowed to or must choose their own competitive supplier of generation and transmission services. In most states with retail choice, the incumbent utility or some other identified entity is designated as a default service provider for customers who do not choose another supplier. In Texas, there is no default service provider and all customers must choose a retail supplier.

### **Revenue requirement**

The annual revenues that the utility is entitled to collect (as modified by adjustment clauses). It is the sum of operations and maintenance expenses, depreciation, taxes and a return on rate base. In most contexts, "revenue requirement" and "cost of service" are synonymous.

**Rider/tariff rider**

A special tariff provision that collects a specified cost or refunds a specific consumer credit, usually over a limited period. See also **adjustment clause** and **tracker**.

**Secondary voltage/secondary service**

Secondary voltage normally includes only voltages under 600 volts. Secondary voltage facilities generally are considered part of the distribution system.

**Service line/service drop**

The conductor directly connecting an electricity customer to the grid, typically between the meter and the line transformer. The term “service drop” derives from the fact that in many cases this line literally drops down from shared transformers attached to overhead lines, but today many are underground.

**Short-run marginal costs/short-run incremental costs**

The costs incurred immediately to expand production and delivery of utility service, not including any capital investments. They are usually much lower than the average of costs but may be higher than average costs during periods of system stress or deficiency of capacity.

**Site infrastructure**

The utility investment that is located at the customer premises and serves no other customers than those located at a single point of delivery from the distribution system. Site infrastructure costs are either paid by the customer at the time of service connection or else classified as customer-related costs in cost of service studies.

**Smart grid**

An integrated network of sophisticated meters, computer controls, information exchange, automation, information processing, data management and pricing options that can create opportunities for improved reliability, increased consumer control over energy costs and more efficient utilization of utility generation and transmission resources.

**Smart meter**

An electric meter with electronics that enable recording of customer usage in short time intervals and two-way communication of data between the utility, the meter and optionally the customer.

**Spinning reserve**

Any energy resource or decremental load that can be called upon within a designated period of time and that system operators may use to balance loads and resources. Spinning reserves may be in the form of generators, energy storage or demand response. Spinning reserves may be designated by how quickly they can be made available, from instantaneously up to some short period of time. In the past, this meant actual rotating (spinning) power plant shafts, but today “spinning” reserves can be provided by battery storage, flywheels or customer load curtailment.

**Straight fixed/variable**

A rate design method that designate much or all of the distribution system as a fixed cost and places all of those costs on customers through customer charges. There are related cost allocation approaches, which designate the entire distribution system as a customer-related cost and transmission and generation capacity as entirely demand-related. See also **minimum system method** and **basic customer method**.

**Stranded costs**

Utility costs for plant that is no longer used or no longer economic. This may include fossil-fueled power plants made uneconomic by new generating technologies; assets that fail to perform before they are fully depreciated; or distribution facilities built to serve customers who are no longer taking utility service, such as failed industrial sites and customers choosing self-generation as a replacement for utility service. Some regulators allow recovery of stranded costs from continuing customers and the inclusion of these costs in the cost of service methodology.

**Substation**

A facility with a transformer that steps voltage down from transmission or subtransmission voltage to distribution voltage, to which one or more circuits or customers may be connected.

**System load factor**

The ratio of the average load of the system to peak load during a specific period of time, expressed as a percentage.

**System peak demand**

The maximum demand placed on the electric system at a single point in time. System peak demand may be a measure for an entire interconnection, for subregions within an interconnection or for individual utilities or service areas.

**Tariff**

A listing of the rates, charges and other terms of service for a utility customer class, as approved by the regulator.

**Test year**

A specific period chosen to demonstrate a utility's need for a rate increase or decrease. It may include adjustments to reflect known and measurable changes in operating revenues, expenses and rate base. A test year can be either historical or projected (often called "future" or "forecast" test year).

**Time-of-use rates/time-varying rates** *Abbreviation:***TOU**

Rates that vary by time of day and day of the week. TOU rates are intended to reflect differences in underlying costs incurred to provide service at different times of the day or week. They may include all costs or reflect only time differentiation in a component of costs such as energy charges or demand charges.

**Total service long-run incremental cost***Abbreviation:* **TSLRIC**

The cost of replicating the current utility system with new power supply, transmission and distribution resources, using current technology, and optimizing the system for

current service needs. Used as a metric for the cost that a new competitive entrant would incur to provide utility services, as an indicator of the equitability of current class cost allocations and rate designs.

**Tracker**

A rate schedule provision giving the utility company the ability to change its rates at different points in time to recognize changes in specific costs of service items without the usual suspension period of a rate filing. Costs included in a tracker are sometimes excluded from cost of service studies. See also **adjustment clause** and **rider/tariff rider**.

**Transformer**

A device that raises (steps up) or lowers (steps down) the voltage in an electric system. Electricity coming out of a generator is often stepped up to very high voltages (230 kV or higher) for injection into the transmission system and then repeatedly stepped down to lower voltages as the distribution system fans out to connect to end-use customers. Some energy loss occurs with every voltage change. Generally, higher voltages can transport energy for longer distances with lower energy losses.

**Transmission/transmission system**

That portion of the electric system designed to carry energy in bulk, typically at voltages above 100 kV. The transmission system is operated at the highest voltage of any portion of the system. It is usually designed to either connect remote generation to local distribution facilities or to interconnect two or more utility systems to facilitate exchanges of energy between systems.

**Transmission and distribution** *Abbreviation:* **T&D**

The combination of transmission service and equipment and distribution service and equipment.

**Used and useful**

A determination on whether investment in utility infrastructure may be recovered in rate base, such that new rates will enable the utility to recover those costs in the future

when that plant will be providing service (i.e., when it will be used and useful). In general, “used” means that the facility is actually providing service, and “useful” means that, without the facility, either costs would be higher or the quality of service would be lower.

**Variable resources/variable renewable resources/intermittent resources**

Technologies that generate electricity under the right conditions, such as when the sun is shining for solar.

**Vertically integrated utility**

A utility that owns its own generating plants (or procures power to serve all customers), transmission system and distribution lines, providing all aspects of electric service.

**Volt** *Abbreviation: V*

The standard unit of potential difference and electromotive force, formally defined to be the difference of electric potential between two points of a conductor carrying a constant current of 1 ampere, when the power dissipated between these points is equal to 1 watt. A kilovolt is equal to 1,000 volts. In abbreviations, the V is capitalized in recognition of electrical pioneer Alessandro Volta.

**Volt-ampere**

A unit used for apparent power in an alternating current electrical circuit, which includes both real power and reactive power. This unit is equivalent to a watt but is particularly relevant in circumstances where voltage and current are out of phase, meaning there is a non-zero amount of reactive power. This unit and its derivatives (e.g., kilovolt-ampere) are typically used for line transformers.

**Volt-ampere reactive** *Acronym: VAR*

A unit by which reactive power is expressed in an alternating current electric power system. Reactive power exists in an alternating current circuit when the current and voltage are not in phase.

**Volumetric energy charges/volumetric rate**

A rate or charge for a commodity or service calculated on the basis of the amount or volume the purchaser receives.

**Watt**

The electric unit used to measure power, capacity or demand. A kilowatt equals 1,000 watts; a megawatt equals 1 million watts or 1,000 kilowatts.

**Watt-hour**

The amount of energy generated or consumed with 1 watt of power over the course of an hour. One kilowatt-hour equals 1,000 watts consumed or delivered for one hour. One megawatt-hour equals 1,000 kilowatt-hours. One terawatt-hour equals 1,000 megawatt-hours. In abbreviations, the W is capitalized in recognition of electrical pioneer James Watt.

**Zero-intercept approach/zero-intercept method**

A method for classifying distribution system costs between customer-related and demand- or energy-related that uses a cost regression calculation to compare components of different size actually used in a system to estimate the costs of a hypothetical zero-capacity distribution system.



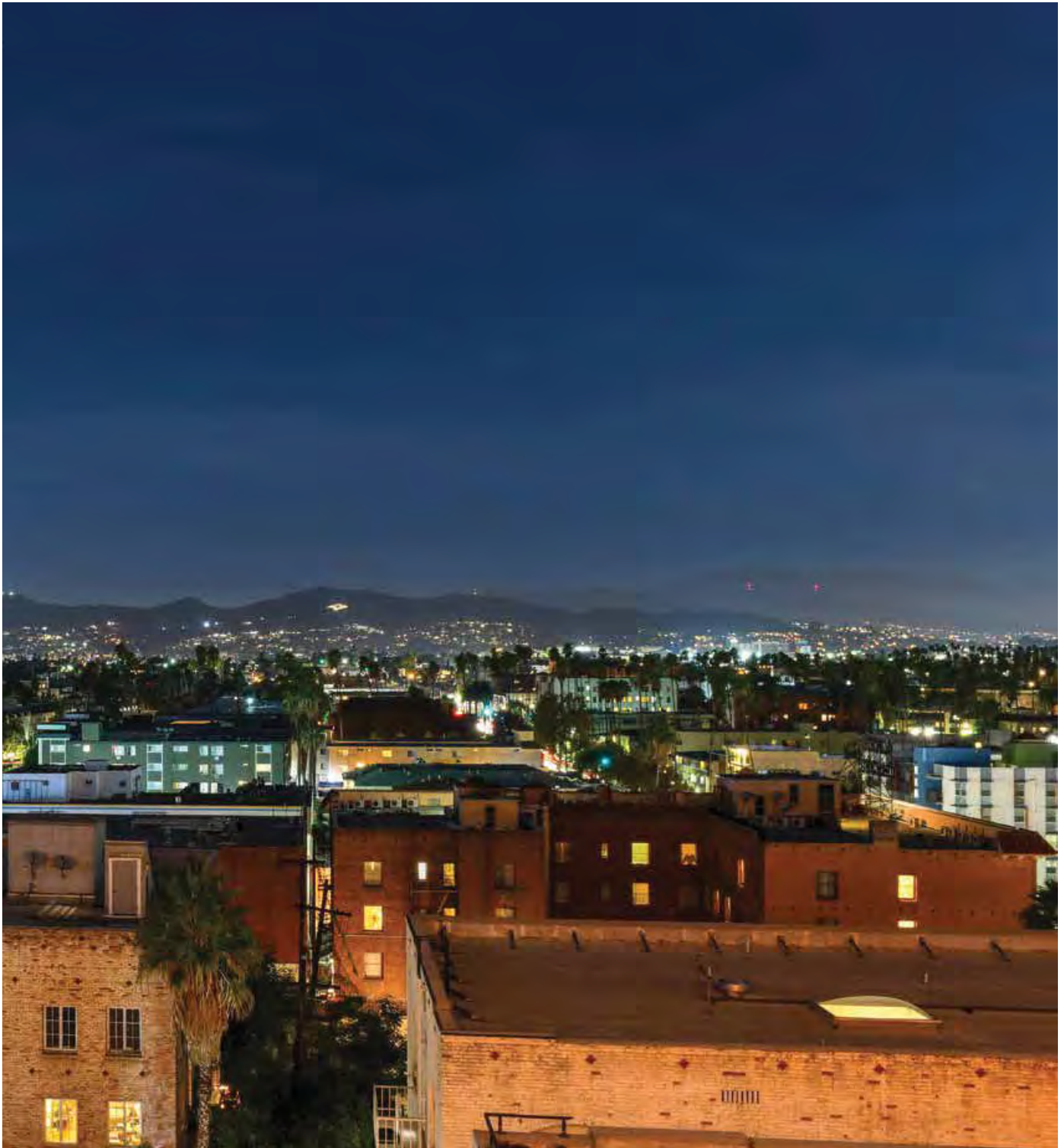

**RAP**<sup>®</sup>

Energy Solutions for a Changing World

Regulatory Assistance Project (RAP)<sup>®</sup>  
Belgium · China · Germany · India · United States

50 State Street, Suite 3  
Montpelier, VT 05602  
USA

802-223-8199  
[raponline.org](http://raponline.org)